

GBJ15005 - GBJ1510/G

Single Phase 15Amp Glass passivated Bridge Rectifiers

Features

- Glass passivated die construction
- Low forward voltage drop
- High current capability
- High surge current capability
- Plastic material-UL flammability 94V-0
- The G suffix is uses for photoresist chip, otherwise it is a knife scraping chip

MECHANICAL DATA

- Case: Molded plastic, GBJ
- Terminals: Plated Leads Solderable perMIL-STD-202, Method 208
- Polarity: As Marked on Case
- Mounting Position: Any
- Marking: Type Number
- Lead Free: For RoHS / Lead Free Version

Mechanical Data

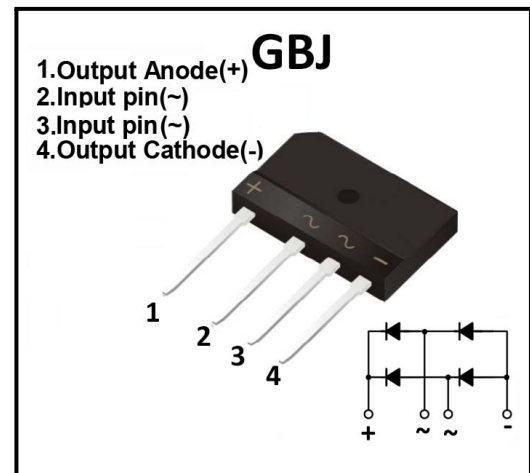

Maximum Ratings And Electrical Characteristics (@T_A=25°C unless otherwise noted)

Symbol	Parameter	GBJ 15005	GBJ 1501	GBJ 1502	GBJ 1504	GBJ 1506	GBJ 1508	GBJ 1510	Unit
V _{RRM}	repetitive peak reverse voltage	50	100	200	400	600	800	1000	V
V _{RWM}	Working Peak Reverse Voltage	50	100	200	400	600	800	1000	
V _{RMS}	RMS voltage	35	70	140	280	420	560	700	
V _{DC}	DC blocking voltage	50	100	200	400	600	800	1000	
I _{FAV}	Average Rectified Output Current (Note 1)@T _C =90°C	15.0							A
I _{FSM}	Peak forward surge current, 8.3ms single half sine-wave	220							A
I _t ²	I _t ² Rating for fusing (t<8.3ms)	200.86							A _S ²
V _{FM}	Forward Voltage @IF=7.5A per element @IF=15A	1.0 1.10							V
I _R	Peak Reverse Current@T _A =25°C at rated DC blocking voltage @T _A =125°C	5.0 500							uA
C _J	Typical junction capacitance	60							pF
R _{θJA}	Between junction and ambient, Without heatsink	12							°C/W
R _{θJC}	Between junction and case, With heatsink	1.2							
T _J	Operation Temperature Range	-55 to +150							°C
T _{STG}	Storage Temperature Range	-55 to +150							

Note:(1)Thermal resistance from junction to case per element. Unit mounted on 75x75x1.6mm aluminum plate heat sink.

BORN SEMICONDUCTOR, INC. ALL RIGHT RESERVED

Specifications are subject to change without notice.

Please refer to <http://www.born-tw.com> for current information.

Revision: 2022-Jan-1



Ratings And Characteristic Curves

Figure 1: Output Current Derating Curve

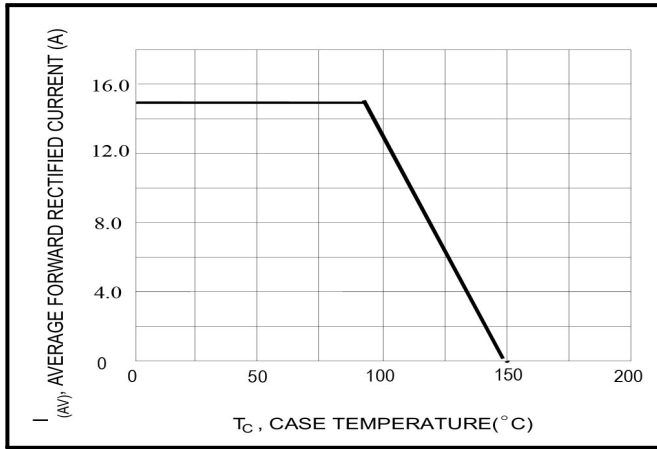

Figure 2: Typical Forward Characteristics (per leg)

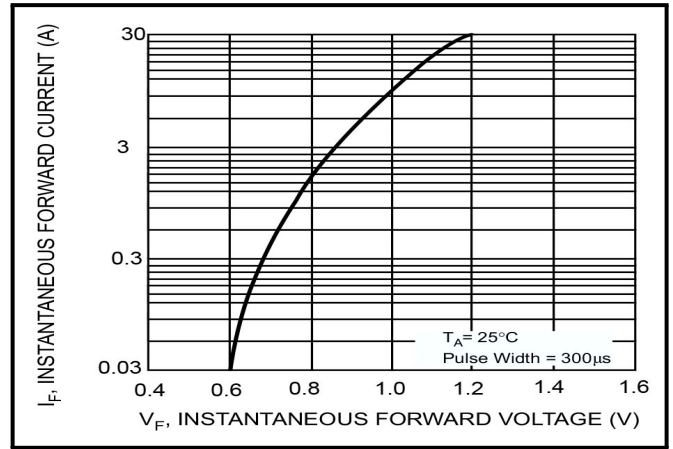

Figure 3: Maximum Peak Forward Surge Current (per leg)

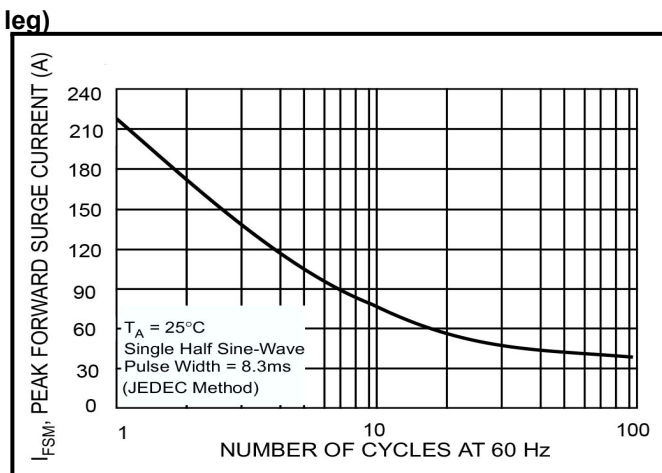

Figure 4: Typical Junction Capacitance

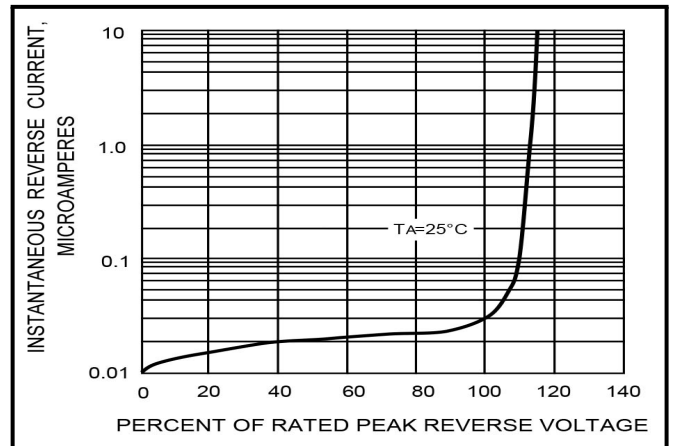
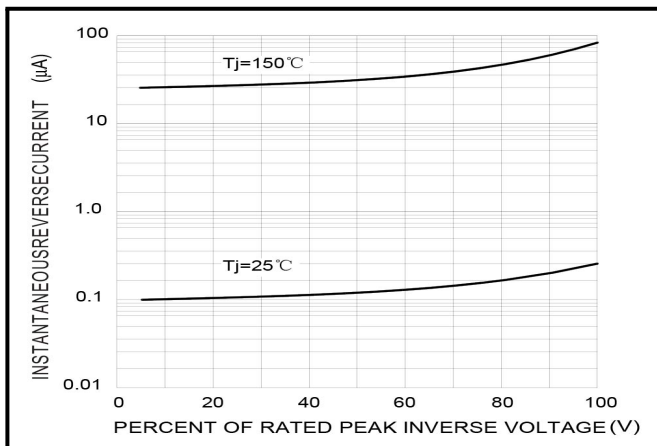

Figure 5: TYPICAL REVERSE CHARACTERISTICS



GBJ15005 - GBJ1510/G

Single Phase 15Amp Glass passivated Bridge Rectifiers

Outline Drawing -GBJ

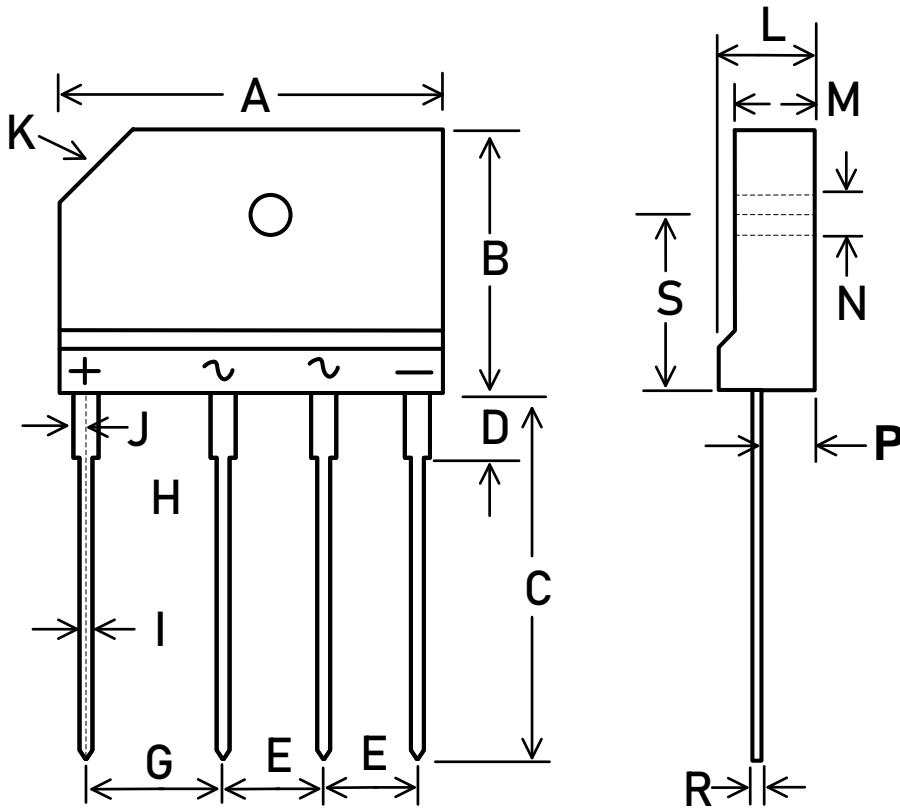

SYMBOL	MILLIMETER	
	MIN.	MAX.
A	29.70	30.3
B	19.70	20.3
C	17.00	18.00
D	3.80	4.20
E	7.30	7.70
G	9.80	10.20
H	2.00	2.40
I	0.90	1.10
J	2.30	2.70
K	3.0x45°	
L	4.40	4.80
M	3.40	3.80
N	3.10	3.40
P	2.50	2.90
R	0.60	0.80
S	10.80	11.20

