





Sensing distance	Supply voltage	Output
5 mm, 1 cm, 31 m 	12 to 24 VDC	 80 to 100 mA

Photoelectric Sensor

E3S-G

Grooved Head Sensors with Built-in DC Amplifiers

- A 1-cm groove type detects marks on transparent film.
- A 3-cm groove type detects edges, labels, and marks.
- LIGHT and STABILITY indicators make sensitivity adjustment easy.



Ordering Information

Application	Groove width	Model	
		NPN output	PNP output
Mark sensing	1 cm	E3S-GS1E4 E3S-GS1RE4 E3S-GS1GE4	E3S-GS1B4 E3S-GS1RB4 E3S-GS1GB4
General-purpose	3 cm	E3S-GS3E4	E3S-GS3B4

Specifications

■ Ratings/Characteristics

Item		E3S-GS1E4/ E3S-GS1B4	E3S-GS1RE4A/ E3S-GS1RB4A	E3S-GS1GE4A/ E3S-GS1GB4A	E3S-GS3E4/ E3S-GS3B4
Power supply voltage		12 to 24 VDC, ripple (p-p): 10% max.			12 VDC -10% to 24 VDC +10%, ripple (p-p): 10% max.
Current consumption		40 mA max.			
Sensing distance		1 cm			3 cm
Standard objects		Transparent (2 x 3 mm)			Opaque and translucent (3 mm)
Control output	DC solid-state	Load	Models with suffix -E4: 80 mA max. Models with suffix -B4: 100 mA max.		
		Voltage output	2 V max.		
Response time (ON, OFF)		1 ms max.			
Sensitivity		Adjustable	10-cycle trimmer		Adjustable
Operation mode		Wire-selectable (Refer to "Output Circuit.")			
Indicators		Light indicator (red), stability indicator (green)			
Enclosure rating	IEC 144	IP65	IP65		IP67
	NEMA	1, 2, 12	1, 2, 12		1, 3, 4X, 6, 12
Housing material		Plastic			Metal
Light source		Green LED	Red LED	Green LED	Infrared LED
Ambient temperature		Operating: -25 to 55 °C			

Engineering Data

Passing Speed vs. Width of Object

E3S-GS3

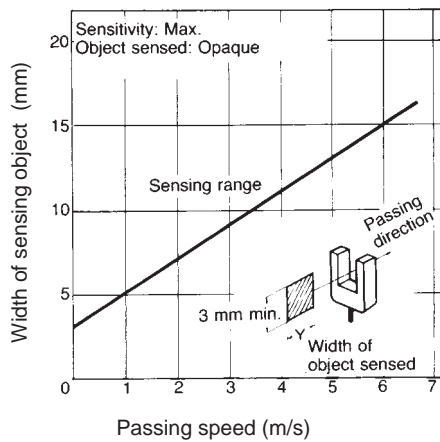

Operation

■ Output Circuits

E3S-GS1E4 (NPN Output)
 E3S-GS1RE4A (NPN Output)
 E3S-GS1GE4A (NPN Output)

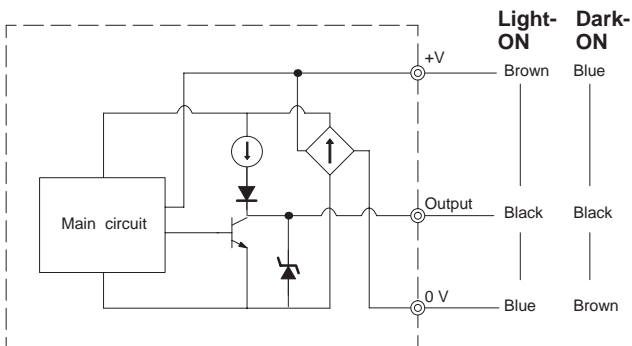

E3S-GS1B4 (PNP Output)
 E3S-GS1RB4A (PNP Output)
 E3S-GS1GB4A (PNP Output)

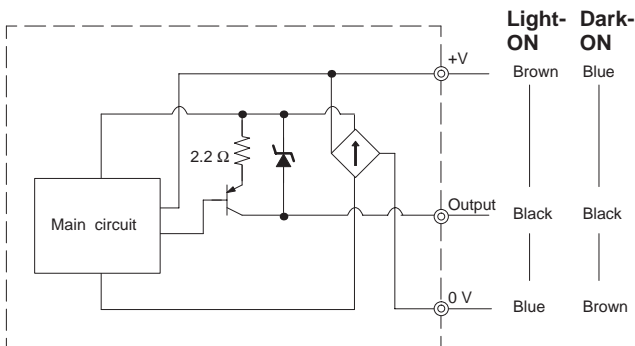

E3S-GS3E4

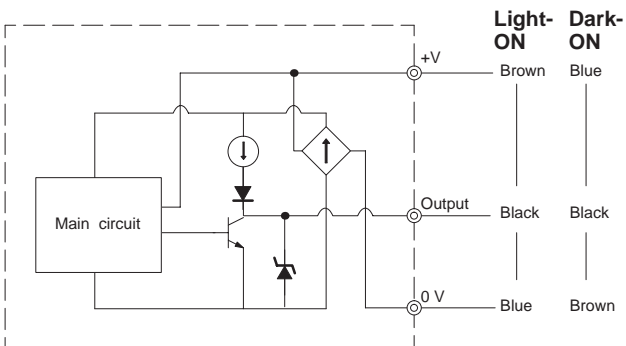

E3S-GS3B4

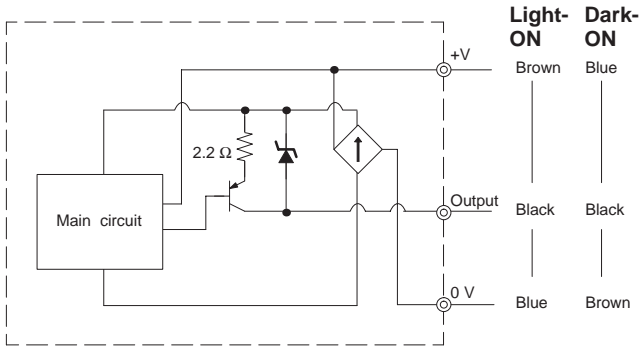

■ Timing Chart

E3S-GS1E4
E3S-GS1RE4A
E3S-GS1GE4A

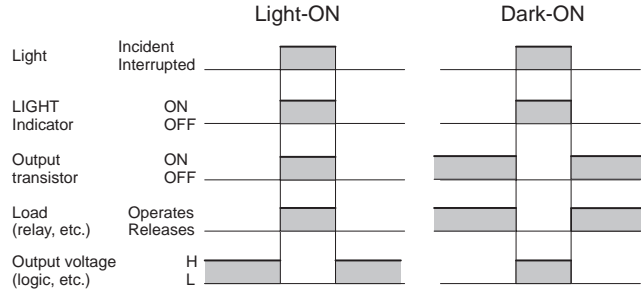

E3S-GS1B4
E3S-GS1RB4A
E3S-GS1GB4A

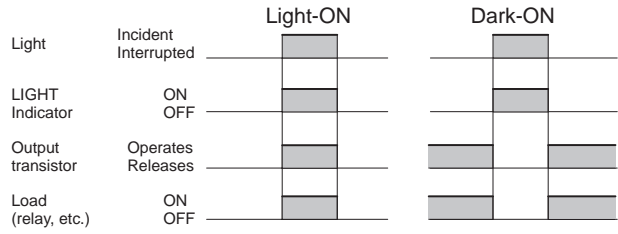

E3S-GS3E4

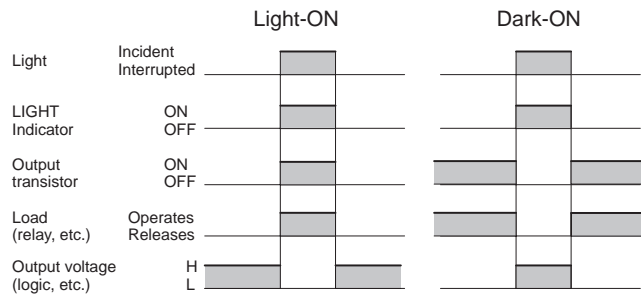

E3S-GS3B4

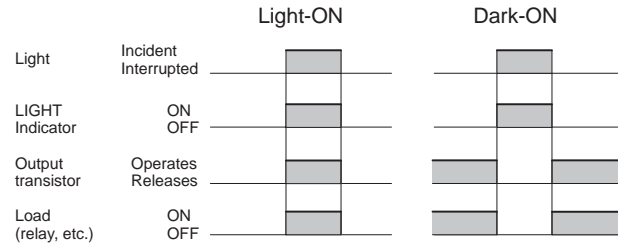

Dimensions

Note: All units are in millimeters unless otherwise indicated.

E3S-GS1□4

Cord: 4-mm dia., 18/0.12, 3-conductor
 Standard length: 2 m
 Weight: approx. 100 g

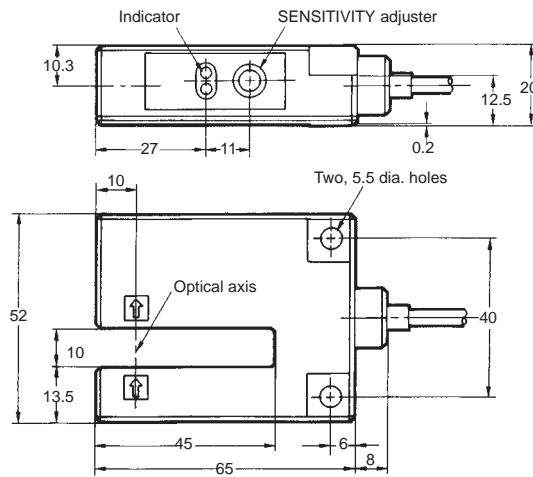
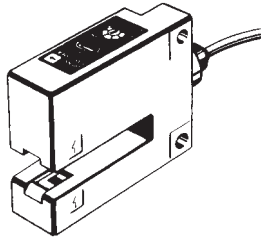

Mounting Holes

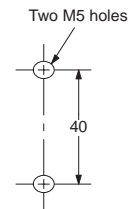

E3S-GS1R□4A E3S-GS1G□4A

Cord: 4-mm dia., 18/0.12, 3-conductor
 Standard length: 2 m
 Weight: approx. 100 g

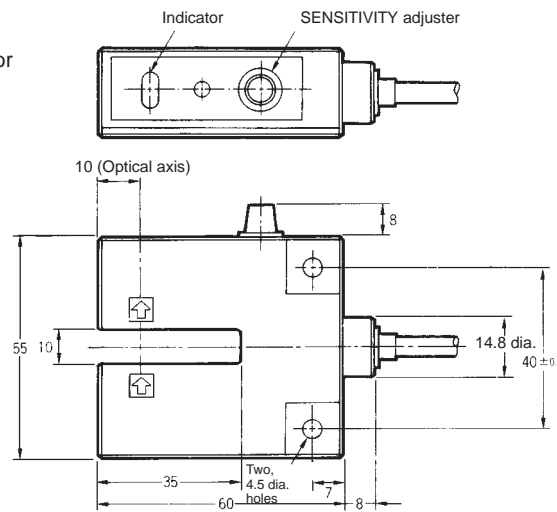
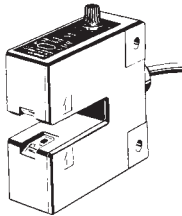

Mounting Holes

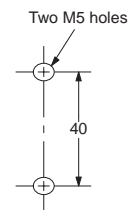

E3S-GS3□4

Cord: 4-mm dia., 18/0.12, 3-conductor
 Standard length: 2 m
 Weight: approx. 230 g

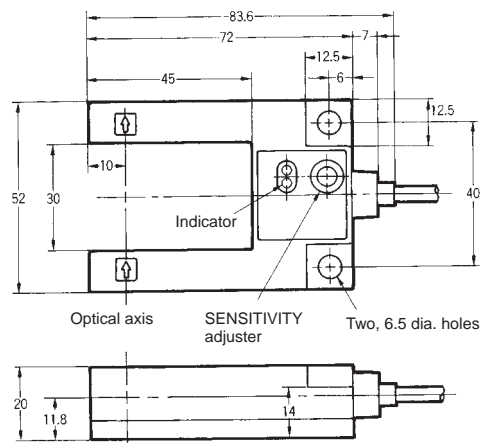
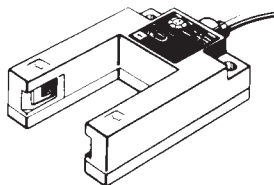

Mounting Holes

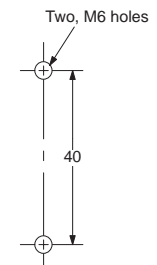

Installation

■ Connections

Relay Load

Note: By connecting the brown (red) and blue (black) wires conversely, the load operates when there is incident light.

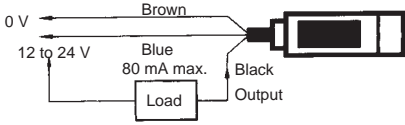
<p>Operating load condition</p>	<p style="text-align: center;">Light-ON</p>
<p>Connection method</p>	

With Sensor Controller (S3D2)

The operation of the sensor is reversible with the signal input selector of the S3D2.

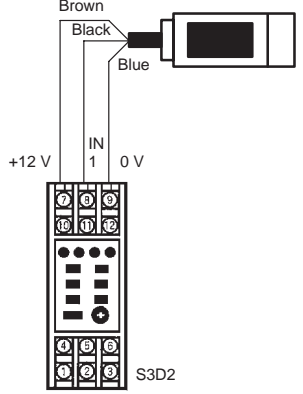
<p>Sensing method</p>	<p style="text-align: center;">Diffuse reflective</p>
<p>Connection method</p>	

ALL DIMENSIONS SHOWN ARE IN MILLIMETERS.

To convert millimeters into inches, multiply by 0.03937. To convert grams into ounces, multiply by 0.03527.

Cat. No. E36-E1-2 **In the interest of product improvement, specifications are subject to change without notice.**

OMRON Corporation

Sensing Components & Systems Division
28th Fl., Crystal Tower Bldg.
1-2-27, Shiromi, Chuo-ku,
Osaka 540 Japan
Phone: 06-949-6012 Fax: 06-949-6021

Printed in Japan
0395-0.5M (0395) a