

**Surface Mount Schottky Barrier Rectifier**

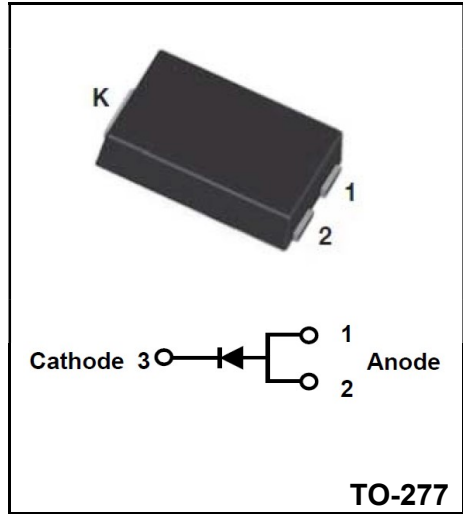
**Reverse Voltage - 40 to 200 V**

**Forward Current - 10 A**



**FEATURES**

- ◆ The plastic package carries Underwriters Laboratory Flammability Classification 94V-0
- ◆ For surface mounted applications
- ◆ Built-in strain relief, ideal for automated placement
- ◆ Low reverse leakage
- ◆ High forward surge current capability
- ◆ High temperature soldering guaranteed 250 C/10 seconds at terminals
- ◆ Lead free in comply with EU RoHS 2011/65/EU directives



**MECHANICAL DATA**

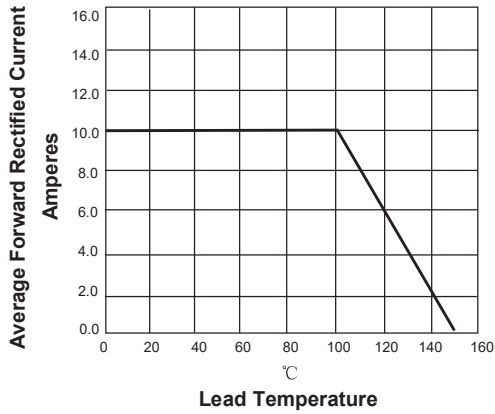
- ◆ Case: TO-277
- ◆ Terminals: Solderable per MIL-STD-750, Method 2026
- ◆ Approx. Weight: 0.003g / 0.092oz

**Absolute Maximum Ratings and Electrical characteristics**  
Ratings at 25 ° ambient temperature unless otherwise specified. Single phase, half wave, 60Hz resistive or inductive load, for capacitive load, derate by 20 %

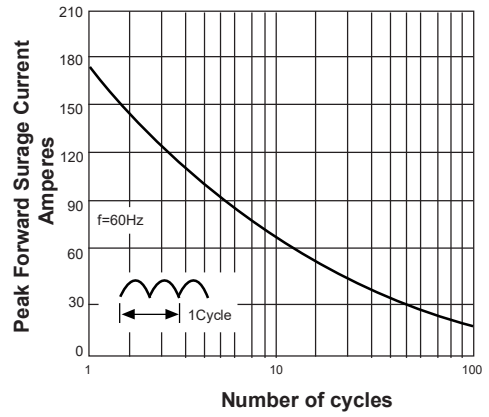
Parameter	Symbols	SS1040SP	SS1045SP	SS1060SP	SS1080SP	SS10100SP	SS10150SP	SS10200SP	Units
Maximum Repetitive Peak Reverse Voltage	$V_{RRM}$	40	45	60	80	100	150	200	V
Maximum RMS voltage	$V_{RMS}$	28	31.5	42	56	70	105	140	V
Maximum DC Blocking Voltage	$V_{DC}$	40	45	60	80	100	150	200	V
Maximum Average Forward Rectified Current TL=100°C	$I_{F(AV)}$	10.0							A
Peak Forward Surge Current, 8.3ms Single Half Sine-wave Superimposed On Rated Load (JEDEC method)	$I_{FSM}$	175.0							A
Maximum Instantaneous Forward Voltage at 10 A	$V_F$	0.55	0.70	0.85		0.95		V	
Maximum Instantaneous Reverse Current at Rated DC Reverse Voltage $T_A = 25^\circ C$ $T_A = 125^\circ C$	$I_R$	0.5 50		0.05 10				mA	
Typical Thermal Resistance	$R_{\theta JA}$	60.0							°C/W
Operating Junction Temperature Range	$T_j$	-55 ~ +150							°C
Storage Temperature Range	$T_{stg}$	-55 ~ +150							°C

**Ratings and Characteristic Curves**

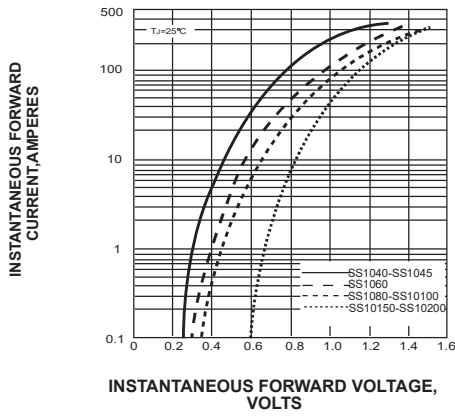
**FIG. 1- DERATING CURVE OUTPUT RECTIFIED CURRENT**



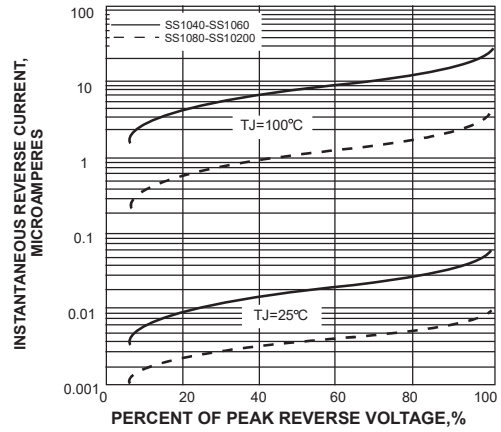
**FIG. 2-MAXIMUM NON-REPETITIVE PEAK FORWARD SURGE CURRENT PER LEG**



**FIG. 3-TYPICAL FORWARD VOLTAGE CHARACTERISTICS**

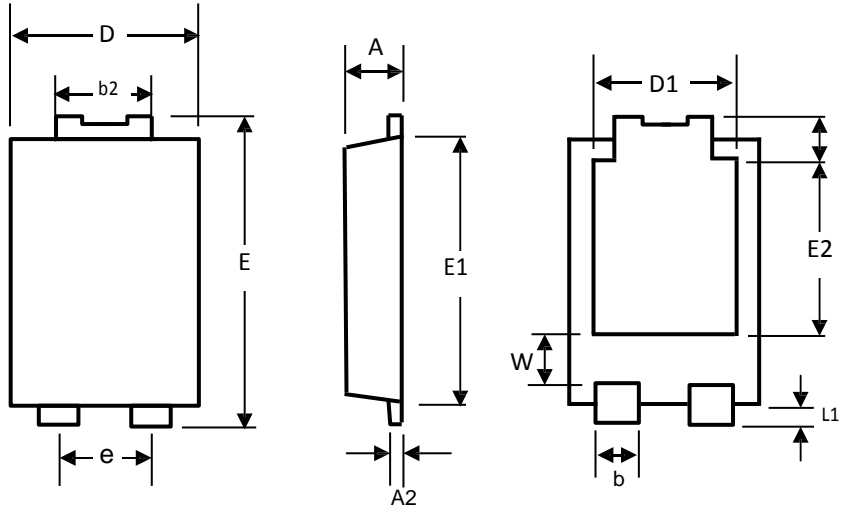


**FIG. 4-TYPICAL REVERSE LEAKAGE CHARACTERISTICS**



**Package Outline TO-277**

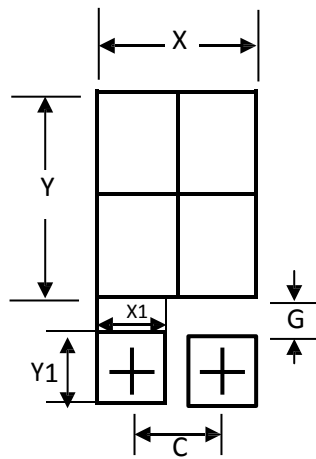
Plastic surface mounted package; 3 leads



Dim	Min	Max
A	1.1	1.2
A2	0.3	0.4
b1	0.8	1
b2	1.7	1.9
D	3.9	4.1
D1	3.054	
E	6.4	6.6
e	1.84	
E1	5.3	5.5
E2	3.549	
L	0.8	1
L1	0.5	0.7
W	1.1	1.4

unit:mm

**Mounting Pad Layout**



Dim	Min
C	1.8
G	0.9
X	3.4
X1	1.4
Y	4.9
Y1	1.4

unit:mm

**Summary of Packing Options**

Package	Packing Description	Packing Quantity	Industry Standard
TO-277	Tape/Reel,13"reel	5000	EIA-481-1