



Inductors for Standard Circuits

Multilayer Ferrite

MLF Series

MLF2012 Type

MLF2012

2012 [0805 inch]*

* Dimensions Code JIS[EIA]

REMINDERS FOR USING THESE PRODUCTS

Before using these products, be sure to request the delivery specifications.

SAFETY REMINDERS

Please pay sufficient attention to the warnings for safe designing when using these products.

REMINDERS

- The storage period is less than 12 months. Be sure to follow the storage conditions (Temperature: 5 to 40°C, Humidity: 10 to 75% RH or less).
If the storage period elapses, the soldering of the terminal electrodes may deteriorate.
- Do not use or store in locations where there are conditions such as gas corrosion (salt, acid, alkali, etc.).
- Before soldering, be sure to preheat components.
The preheating temperature should be set so that the temperature difference between the solder temperature and chip temperature does not exceed 150°C.
- Soldering corrections after mounting should be within the range of the conditions determined in the specifications.
If overheated, a short circuit, performance deterioration, or lifespan shortening may occur.
- When embedding a printed circuit board where a chip is mounted to a set, be sure that residual stress is not given to the chip due to the overall distortion of the printed circuit board and partial distortion such as at screw tightening portions.
- Self heating (temperature increase) occurs when the power is turned ON, so the tolerance should be sufficient for the set thermal design.
- Carefully lay out the coil for the circuit board design of the non-magnetic shield type.
A malfunction may occur due to magnetic interference.
- Use a wrist band to discharge static electricity in your body through the grounding wire.
- Do not expose the products to magnets or magnetic fields.
- Do not use for a purpose outside of the contents regulated in the delivery specifications.
- The products listed on this catalog are intended for use in general electronic equipment (AV equipment, telecommunications equipment, home appliances, amusement equipment, computer equipment, personal equipment, office equipment, measurement equipment, industrial robots) under a normal operation and use condition.
The products are not designed or warranted to meet the requirements of the applications listed below, whose performance and/or quality require a more stringent level of safety or reliability, or whose failure, malfunction or trouble could cause serious damage to society, person or property.
If you intend to use the products in the applications listed below or if you have special requirements exceeding the range or conditions set forth in the each catalog, please contact us.

- (1) Aerospace/Aviation equipment
- (2) Transportation equipment (cars, electric trains, ships, etc.)
- (3) Medical equipment
- (4) Power-generation control equipment
- (5) Atomic energy-related equipment
- (6) Seabed equipment
- (7) Transportation control equipment

- (8) Public information-processing equipment
- (9) Military equipment
- (10) Electric heating apparatus, burning equipment
- (11) Disaster prevention/crime prevention equipment
- (12) Safety equipment
- (13) Other applications that are not considered general-purpose applications

When designing your equipment even for general-purpose applications, you are kindly requested to take into consideration securing protection circuit/device or providing backup circuits in your equipment.

Inductors for Standard Circuits

Multilayer Ferrite

Product compatible with RoHS directive
Halogen-free
Compatible with lead-free solders

Overview of MLF2012 Type

FEATURES

- The lineup includes a wide inductance range.
- Highly reliable monolithic structure with multilayer integration.

APPLICATION

Smart phones, tablet terminals, tuners, LCD-TVs, PDP-TVs, audio equipment, computers, signal processing for modules etc.

PART NUMBER CONSTRUCTION

MLF	2012	D	47N	△	T	000			
Series name	L×W×H Dimensions (mm)		Inductance (μH)		Inductance tolerance		Packaging style		Internal code
2012	2.0×1.25×0.85	A	10N	0.010 (10nH)	J	±5%	T	Taping	000
		C			K	±10%			
	2.0×1.25×1.25	D	R10	0.1	M	±20%			
		E	1R0	1					
	K	100	10						

OPERATING TEMPERATURE RANGE, PACKAGE QUANTITY, PRODUCT WEIGHT

Type	Temperature range*		Package quantity (pieces/reel)	Individual weight (mg)
	Operating temperature (°C)	Storage temperature** (°C)		
MLF2012	t=0.85	-55 to +125	4,000	10
	t=1.25			

* In case the product's inductance is 15μH or higher, both Operating and Storage temperature ranges are -40 to +85°C.

** The Storage temperature range is for after the circuit board is mounted.

- RoHS Directive Compliant Product: See the following for more details.<https://product.tdk.com/info/en/environment/rohs/index.html>
- Halogen-free: Indicates that Cl content is less than 900ppm, Br content is less than 900ppm, and that the total Cl and Br content is less than 1500ppm.

⚠ Please be sure to request delivery specifications that provide further details on the features and specifications of the products for proper and safe use.
Please note that the contents may change without any prior notice due to reasons such as upgrading.

MLF2012 Type

RECOMMENDED REFLOW PROFILE

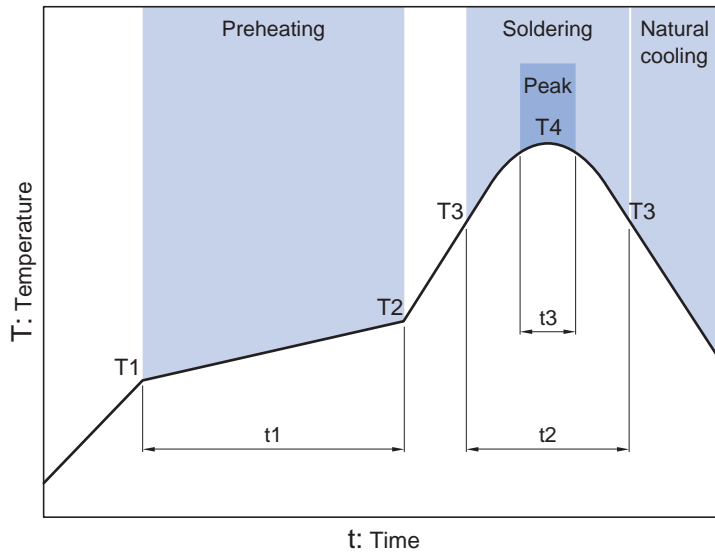

Preheating			Soldering		Peak	
Temp.	Temp.	Time	Temp.	Time	Temp.	Time
T1	T2	t1	T3	t2	T4	t3
150°C	180°C	60 to 120s	230°C	30 to 60s	250 to 260°C	10s max.

MLF2012 Type

SHAPE & DIMENSIONS

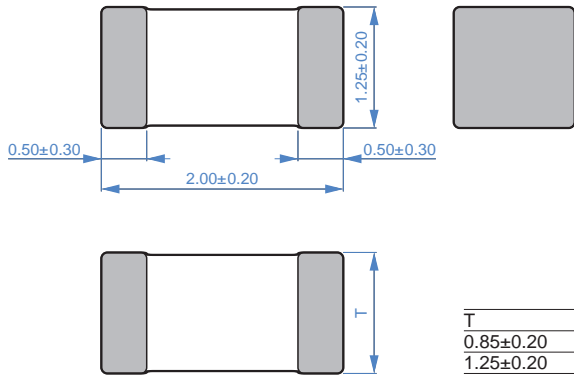

Dimensions in mm



RECOMMENDED LAND PATTERN

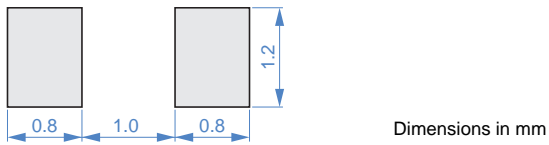

Dimensions in mm

 Please be sure to request delivery specifications that provide further details on the features and specifications of the products for proper and safe use. Please note that the contents may change without any prior notice due to reasons such as upgrading.

MLF2012 Type

ELECTRICAL CHARACTERISTICS

CHARACTERISTICS SPECIFICATION TABLE

L (μ H)	Q Tolerance	Q		L, Q measuring conditions		Self-resonant frequency		DC resistance		Rated current (mA) max.	Thickness T (mm)	Part No.*
		min.	typ.	Frequency (MHz)	Current (mA)	(MHz) min.	(MHz) typ.	(Ω) max.	(Ω) typ.			
0.047	$\pm 20\%$	15	25	50	1.0	550	700	0.10	0.05	300	0.85	MLF2012D47N \triangle T000
0.068	$\pm 20\%$	15	25	50	1.0	500	600	0.15	0.08	300	0.85	MLF2012D68N \triangle T000
0.082	$\pm 20\%$	15	25	50	1.0	450	550	0.15	0.08	300	0.85	MLF2012D82N \triangle T000
0.10	$\pm 5\% \pm 10\% \pm 20\%$	20	30	25	1.0	400	500	0.15	0.10	300	0.85	MLF2012DR10 \triangle T000
0.12	$\pm 5\% \pm 10\% \pm 20\%$	20	30	25	1.0	360	450	0.20	0.12	300	0.85	MLF2012DR12 \triangle T000
0.15	$\pm 5\% \pm 10\% \pm 20\%$	20	30	25	1.0	320	410	0.20	0.13	300	0.85	MLF2012DR15 \triangle T000
0.18	$\pm 5\% \pm 10\% \pm 20\%$	20	30	25	1.0	280	370	0.25	0.15	300	0.85	MLF2012DR18 \triangle T000
0.22	$\pm 5\% \pm 10\% \pm 20\%$	20	30	25	1.0	250	330	0.30	0.16	250	0.85	MLF2012DR22 \triangle T000
0.27	$\pm 5\% \pm 10\% \pm 20\%$	20	30	25	1.0	220	300	0.35	0.18	250	0.85	MLF2012DR27 \triangle T000
0.33	$\pm 5\% \pm 10\% \pm 20\%$	20	30	25	1.0	200	270	0.40	0.23	250	0.85	MLF2012DR33 \triangle T000
0.39	$\pm 5\% \pm 10\% \pm 20\%$	25	35	25	1.0	180	250	0.45	0.25	200	0.85	MLF2012DR39 \triangle T000
0.47	$\pm 5\% \pm 10\% \pm 20\%$	25	35	25	1.0	160	230	0.50	0.25	200	1.25	MLF2012DR47 \triangle T000
0.56	$\pm 5\% \pm 10\% \pm 20\%$	25	35	25	1.0	150	210	0.55	0.30	150	1.25	MLF2012DR56 \triangle T000
0.68	$\pm 5\% \pm 10\% \pm 20\%$	25	35	25	1.0	140	190	0.60	0.35	150	1.25	MLF2012DR68 \triangle T000
0.82	$\pm 5\% \pm 10\% \pm 20\%$	25	35	25	1.0	130	170	0.65	0.40	150	1.25	MLF2012DR82 \triangle T000
1.0	$\pm 5\% \pm 10\% \pm 20\%$	45	55	10	1.0	120	160	0.30	0.15	80	0.85	MLF2012A1R0 \triangle T000
1.2	$\pm 5\% \pm 10\% \pm 20\%$	45	55	10	1.0	110	150	0.35	0.15	80	0.85	MLF2012A1R2 \triangle T000
1.5	$\pm 5\% \pm 10\% \pm 20\%$	45	60	10	1.0	100	140	0.40	0.18	80	0.85	MLF2012A1R5 \triangle T000
1.8	$\pm 5\% \pm 10\% \pm 20\%$	45	60	10	1.0	90	130	0.45	0.20	80	0.85	MLF2012A1R8 \triangle T000
2.2	$\pm 5\% \pm 10\% \pm 20\%$	45	60	10	1.0	80	120	0.50	0.22	50	0.85	MLF2012A2R2 \triangle T000
2.7	$\pm 5\% \pm 10\% \pm 20\%$	45	70	10	1.0	70	100	0.55	0.25	50	1.25	MLF2012A2R7 \triangle T000
3.3	$\pm 5\% \pm 10\% \pm 20\%$	45	70	10	1.0	60	90	0.60	0.28	50	1.25	MLF2012A3R3 \triangle T000
3.9	$\pm 5\% \pm 10\% \pm 20\%$	45	70	10	1.0	55	80	0.65	0.30	30	1.25	MLF2012A3R9 \triangle T000
4.7	$\pm 5\% \pm 10\% \pm 20\%$	45	70	10	1.0	50	70	0.70	0.35	30	1.25	MLF2012A4R7 \triangle T000
5.6	$\pm 5\% \pm 10\% \pm 20\%$	50	75	4	0.1	45	65	0.60	0.30	15	1.25	MLF2012E5R6 \triangle T000
6.8	$\pm 5\% \pm 10\% \pm 20\%$	50	75	4	0.1	40	60	0.65	0.32	15	1.25	MLF2012E6R8 \triangle T000
8.2	$\pm 5\% \pm 10\% \pm 20\%$	50	75	4	0.1	35	55	0.70	0.35	15	1.25	MLF2012E8R2 \triangle T000
10	$\pm 5\% \pm 10\% \pm 20\%$	50	75	2	0.1	30	50	0.80	0.40	15	1.25	MLF2012E100 \triangle T000
12	$\pm 5\% \pm 10\% \pm 20\%$	50	75	2	0.1	25	45	0.90	0.50	15	1.25	MLF2012E120 \triangle T000
15	$\pm 10\% \pm 20\%$	30	45	1	0.1	22	40	0.70	0.35	5	1.25	MLF2012C150 \triangle T000
18	$\pm 10\% \pm 20\%$	30	45	1	0.1	20	38	0.80	0.38	5	1.25	MLF2012C180 \triangle T000
22	$\pm 10\% \pm 20\%$	30	45	1	0.1	18	35	0.90	0.45	5	1.25	MLF2012C220 \triangle T000
27	$\pm 10\% \pm 20\%$	30	45	1	0.1	17	33	1.00	0.50	5	1.25	MLF2012C270 \triangle T000
33	$\pm 10\% \pm 20\%$	30	45	0.4	0.1	15	28	1.10	0.55	5	1.25	MLF2012C330 \triangle T000
39	$\pm 10\% \pm 20\%$	35	55	2	0.1	13	23	2.40	1.30	4	1.25	MLF2012K390 \triangle T000
47	$\pm 10\% \pm 20\%$	35	55	2	0.1	11	20	2.70	1.60	4	1.25	MLF2012K470 \triangle T000
56	$\pm 10\% \pm 20\%$	35	55	2	0.1	10	18	2.80	1.80	4	1.25	MLF2012K560 \triangle T000
68	$\pm 10\% \pm 20\%$	25	45	1	0.1	9	16	2.90	2.00	2	1.25	MLF2012C680 \triangle T000
82	$\pm 10\% \pm 20\%$	25	45	1	0.1	8	14	3.00	2.40	2	1.25	MLF2012C820 \triangle T000
100	$\pm 10\% \pm 20\%$	25	45	1	0.1	7	12	3.10	2.50	2	1.25	MLF2012C101 \triangle T000

* The " \triangle " of the Part Number contains the inductance tolerance code, J ($\pm 5\%$), K ($\pm 10\%$), or M ($\pm 20\%$).

Measurement equipment

Measurement item	Product No.	Manufacturer
L, Q	4294A+16034G	Keysight Technologies
Self-resonant frequency	E4991A	Keysight Technologies
DC resistance	Type-7561	Yokogawa

* Equivalent measurement equipment may be used.

MLF2012 Type

ELECTRICAL CHARACTERISTICS

FREQUENCY CHARACTERISTICS GRAPH

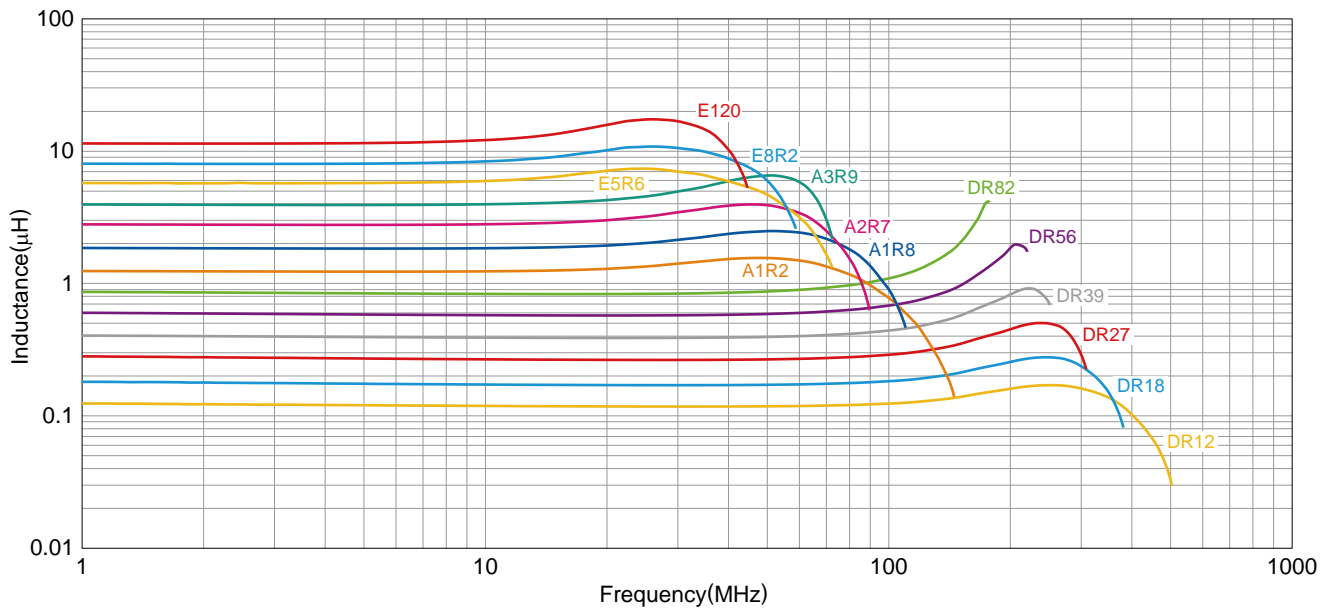
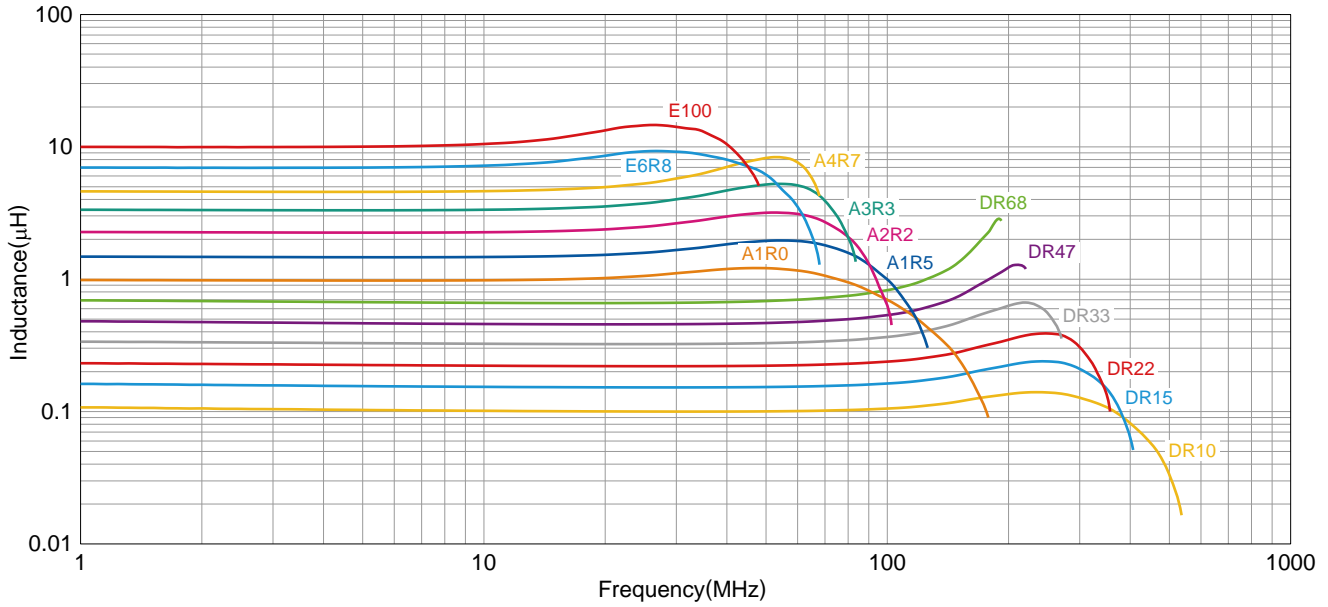

○ Measurement equipment

Product No.	Manufacturer
E4991A+16192A	Keysight Technologies

* Equivalent measurement equipment may be used.

 Please be sure to request delivery specifications that provide further details on the features and specifications of the products for proper and safe use.
Please note that the contents may change without any prior notice due to reasons such as upgrading.

MLF2012 Type

ELECTRICAL CHARACTERISTICS

L FREQUENCY CHARACTERISTICS GRAPH

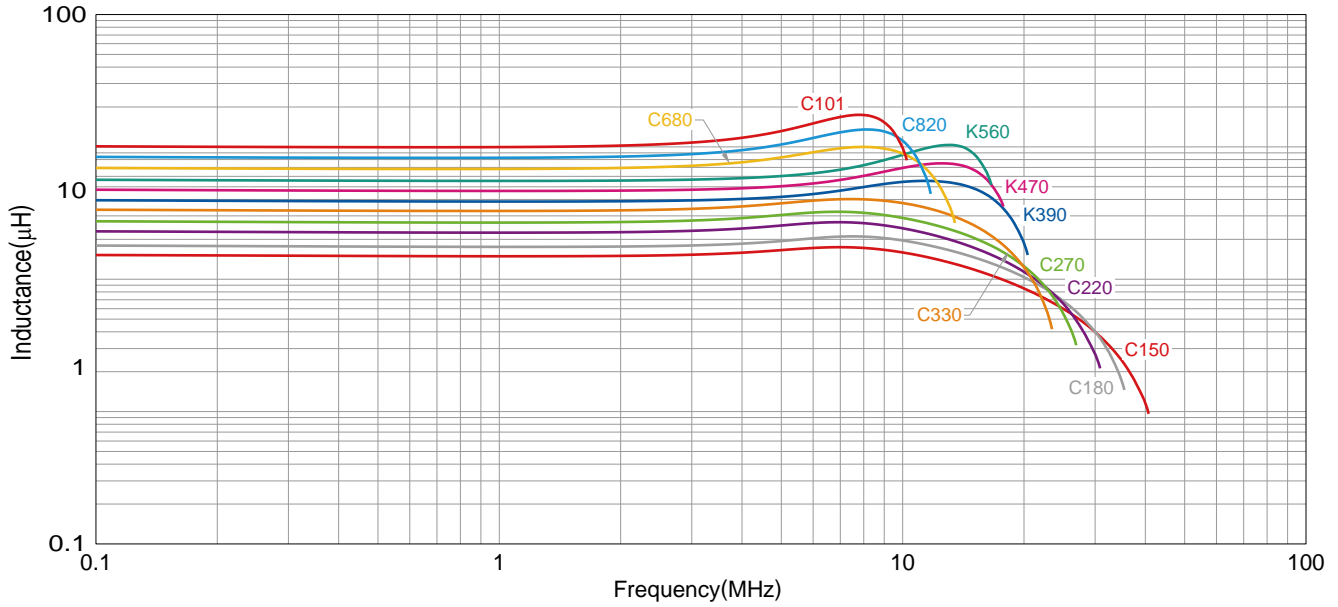

○ Measurement equipment

Product No.	Manufacturer
4294A+16034G	Keysight Technologies

* Equivalent measurement equipment may be used.

 Please be sure to request delivery specifications that provide further details on the features and specifications of the products for proper and safe use.
Please note that the contents may change without any prior notice due to reasons such as upgrading.

MLF2012 Type

ELECTRICAL CHARACTERISTICS

Q FREQUENCY CHARACTERISTICS GRAPH

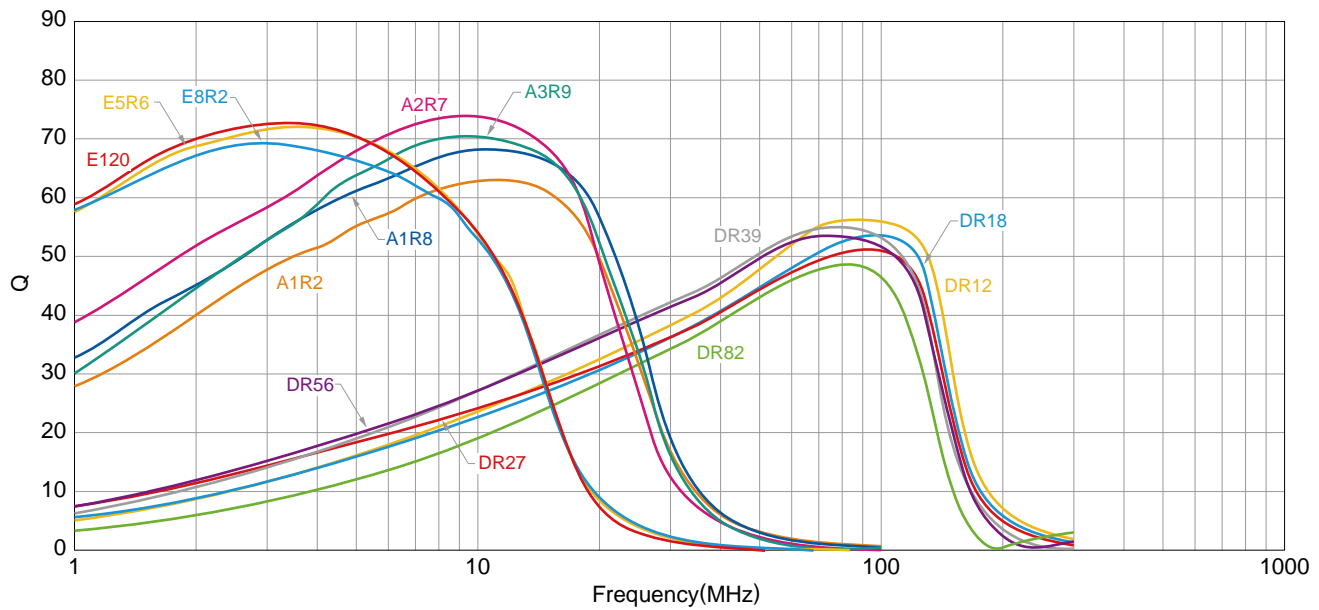
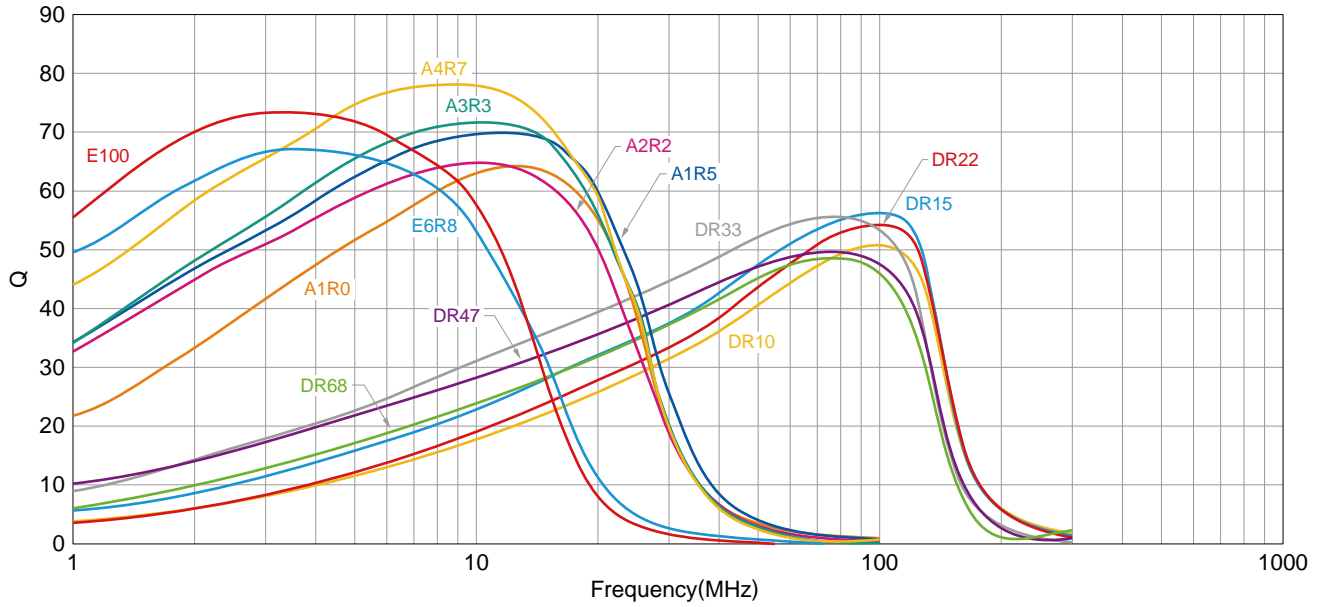

○ Measurement equipment

Product No.	Manufacturer
E4991A+16192A	Keysight Technologies

* Equivalent measurement equipment may be used.

 Please be sure to request delivery specifications that provide further details on the features and specifications of the products for proper and safe use. Please note that the contents may change without any prior notice due to reasons such as upgrading.

MLF2012 Type

Q FREQUENCY CHARACTERISTICS GRAPH

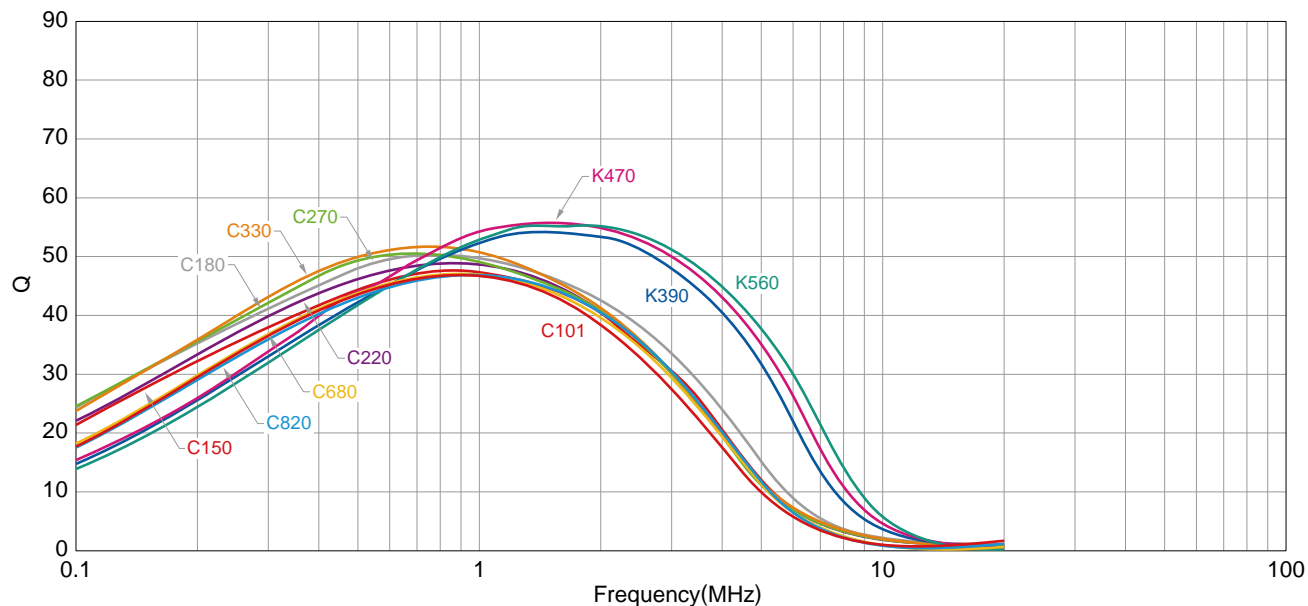

○ Measurement equipment

Product No.	Manufacturer
4294A+16034G	Keysight Technologies

* Equivalent measurement equipment may be used.

MLF2012 Type

PACKAGING STYLE

REEL DIMENSIONS

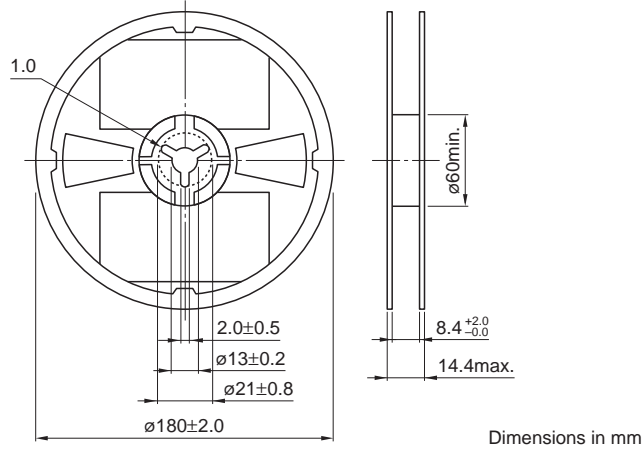

TAPE DIMENSIONS

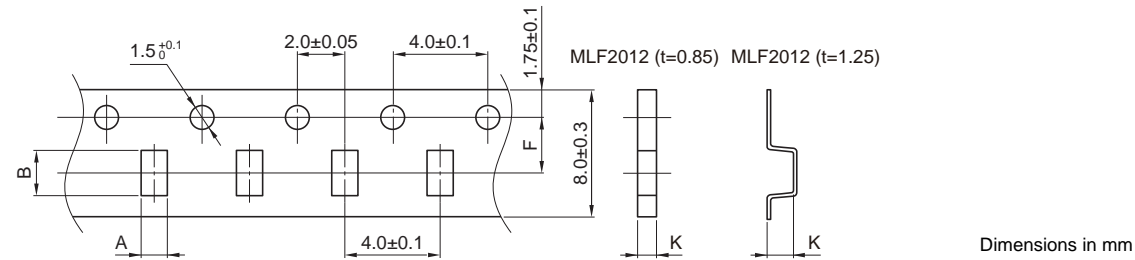

Type	A	B	K	
MLF2012	t=0.85	1.5±0.2	2.3±0.2	1.1 max.
	t=1.25	1.5±0.2	2.3±0.2	1.5 max.

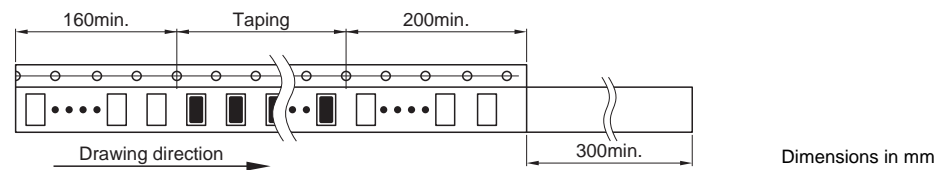

 Please be sure to request delivery specifications that provide further details on the features and specifications of the products for proper and safe use. Please note that the contents may change without any prior notice due to reasons such as upgrading.