

Linear Guides NS CL-AL

AL/CL sliders with light-(Z) or medium(H) preload are standard stock items with prompt delivery

AL: Normal length, low height-square type slider with tap holes on top

CL: Short length, low height-square type slider with tap holes on top

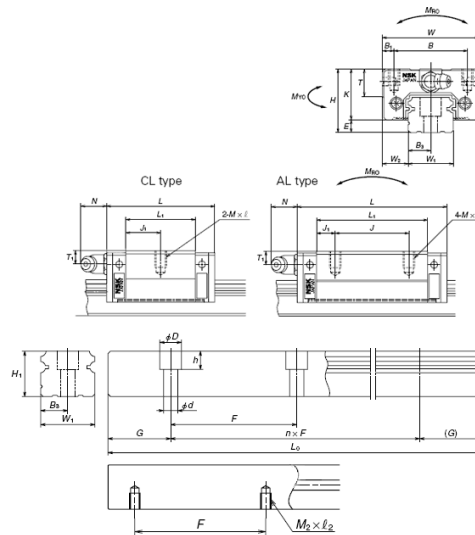

Model-No.

N1S150300LCNPCZ-30-30

Type

Linear Guide NS Series



Type	Rail only
Size	15
Slider type	-
Number of sliders	-
Lubrication unit K1	No
Double seal	No
Metal protector	No
Material / Surface treatment	C
Length of rail	300
Distance to first hole center (G1)	30
Distance to last hole center (G2)	30
Accuracy	PC
Preload	Z
H	-
E	-
W2	-
W	-
B	-

Created: 2014-12-05 13:40:03

Address:

NSK Europe Ltd
Harkortstrasse 15
D-40880 Ratingen
Germany

Phone:
Fax:
Web:
Email:

49 2102 481 0
49 2102 481 2881
<http://www.nskeurope.de>
info-de@nsk.com



J	-
L	-
L1	-
J1	-
K	-
T	-
M x l	-
Grease fitting	-
T1	-
N	-
Dynamic C (N)	-
Static C0 (N)	-
MRO (Nm)	-
MPO (Nm)	-
MYO (Nm)	-
Weight slider (kg)	-
W1	15
H1	12.5
F	60
d x D x h (L1S15T)	3,5 x 6 x 4,5
M2x12	M5x7
B3	7.5
G (recommended)	20
Weight rail (kg/m)	1.4