

### Foot-switch (2 pedals) Protective guard UN

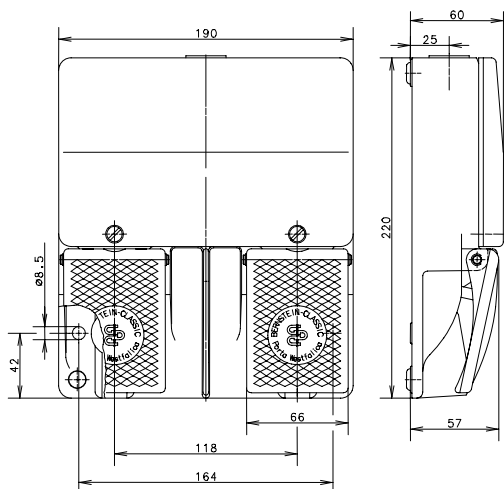

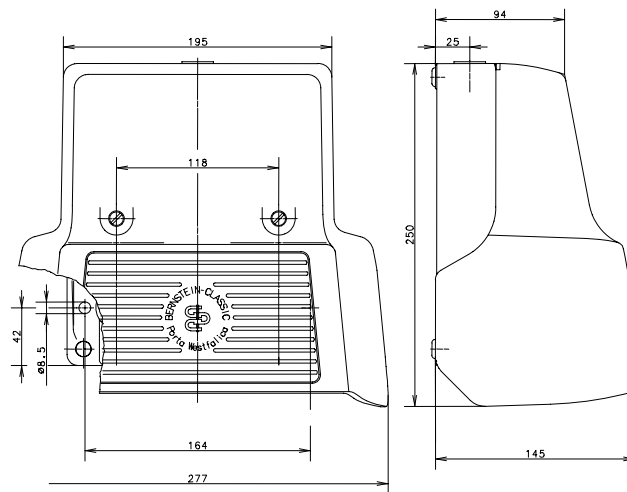



**F2**

Standard

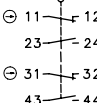
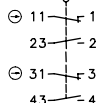
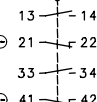
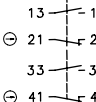

**F2 (UN)**

Left pedal (Switching symbol)	Right pedal (Switching symbol)	Contact type	F2 With cover	F2 With protective guard
<p><b>U1Z</b></p>  <p>Slow-action contact</p>	<p><b>U1Z</b></p>  <p>Slow-action contact</p>	2 N.C. 2 N.O. (Zb)	6062110013 F2-U1Z/U1Z with BG (see page 5)	6062610014 F2-U1Z/U1Z UN with BG (see page 5)
<p><b>SU1Z</b></p>  <p>Snap-action contact</p>	<p><b>SU1Z</b></p>  <p>Snap-action contact</p>	2 N.C. 2 N.O. (Zb)	6062330021 F2-SU1Z/SU1Z with BG (see page 5)	6062830022 F2-SU1Z/SU1Z UN with BG (see page 5)
<p><b>U2Z</b></p>  <p>Slow-action contact</p>	<p><b>U2Z</b></p>  <p>Slow-action contact</p>	4 N.C. 4 N.O. (Zb)	6062220015 F2-U2Z/U2Z with BG (see page 5)	6062720016 F2-U2Z/U2Z UN with BG (see page 5)
<p><b>SU2Z</b></p>  <p>Snap-action contact</p>	<p><b>SU2Z</b></p>  <p>Snap-action contact</p>	4 N.C. 4 N.O. (Zb)	---	6062940066 F2-SU2Z/SU2Z UN with BG (see page 5)

This document will not become the contractual basis; the details included herein do not constitute any descriptions of expected conditions, so that warranties/claims for defects on account of possible variations of the actual qualities from the qualities described herein are explicitly excluded. All rights reserved. Specifications subject to change without notice!

Date of issue: 19.10.2007 / Page 1 of 5  
Document : 7100003\_en / Status : 5 / 2691-07

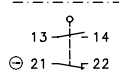
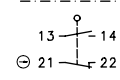
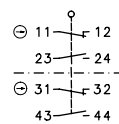
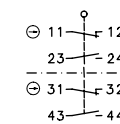
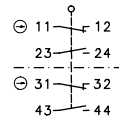
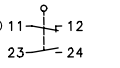

### Pressure point (D)

Left pedal (Switching symbol)	Right pedal (Switching symbol)	Contact type	F2 With cover	F2 With protective guard
<p><b>SU1ZD</b></p> <p>Pressure point</p>  <p>Snap-action contact</p>	<p><b>SU1ZD</b></p> <p>Pressure point</p>  <p>Snap-action contact</p>	<p>2 N.C. 2 N.O. (Zb)</p>	<p>---</p> <p>---</p>	<p>6062830417 F2-SU1ZD/SU1ZD UN with BG (see page 5)</p>
<p><b>U2ZD</b></p> <p>Pressure point</p>  <p>Slow-action contact</p>	<p><b>U2ZD</b></p> <p>Pressure point</p>  <p>Slow-action contact</p>	<p>4 N.C. 4 N.O. (Zb)</p>	<p>6062220019 F2-U2ZD/U2ZD with BG (see page 5)</p>	<p>6062720020 F2-U2ZD/U2ZD UN with BG (see page 5)</p>
<p><b>U2ZD</b></p> <p>Pressure point</p>  <p>Slow-action contact</p>	<p><b>U1Z</b></p> <p>Pressure point</p>  <p>Slow-action contact</p>	<p>3 N.C. 3 N.O. (Zb)</p>	<p>---</p> <p>---</p>	<p>6062710376 F2-U2ZD/U1Z UN</p>

This document will not become the contractual basis; the details included herein do not constitute any descriptions of expected conditions, so that warranties/claims for defects on account of possible variations of the actual qualities from the qualities described herein are explicitly excluded. All rights reserved. Specifications subject to change without notice!

Date of issue: 19.10.2007 / Page 2 of 5  
Document : 7100003\_en / Status : 5 / 2691-07

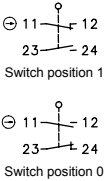
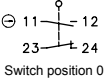
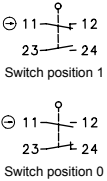
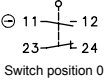
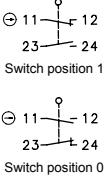
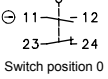
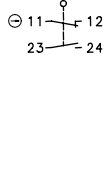
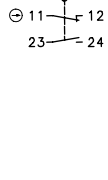
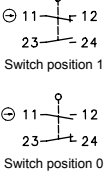
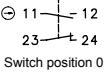
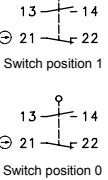
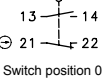
### Latch Contact (Y)

Left pedal (Switching symbol)	Right pedal (Switching symbol)	Contact type	F2 With cover	F2 With protective guard
<p><b>U1ZY</b></p>  <p>Switch position 1</p>  <p>Switch position 0</p> <p>Slow-action contact</p>	<p><b>U1ZY</b></p>  <p>Switch position 1</p>  <p>Switch position 0</p> <p>Slow-action contact</p>	2 N.C. 2 N.O. (Zb)	6062110017 F2-U1ZY/U1ZY	6062610018 F2-U1ZY/U1ZY UN
<p><b>U1ZY</b></p>  <p>Switch position 1</p>  <p>Switch position 0</p> <p>Slow-action contact</p>	<p><b>U1Z</b></p>  <p>Slow-action contact</p>	2 N.C. 2 N.O. (Zb)	6062110368 F2-U1ZY/U1Z	6062610047 F2-U1ZY/U1Z UN
<p><b>U1Z</b></p>  <p>Slow-action contact</p>	<p><b>U1ZY</b></p>  <p>Switch position 1</p>  <p>Switch position 0</p> <p>Slow-action contact</p>	2 N.C. 2 N.O. (Zb)	---	6062610078 F2-U1Z/U1ZY UN
<p><b>SU1ZY</b></p>  <p>Switch position 1</p>  <p>Switch position 0</p> <p>Snap-action contact</p>	<p><b>SU1Z</b></p>  <p>Switch position 1</p>  <p>Switch position 0</p> <p>Snap-action contact</p>	2 N.C. 2 N.O. (Zb)	6062330449 F2-SU1ZY/SU1Z	---

Switch position 1: normally closed contact: closed, Make contact: open (self-holding contact)  
 Switch position 0: normally closed contact: open, Make contact: closed (self-holding contact)

This document will not become the contractual basis; the details included herein do not constitute any descriptions of expected conditions, so that warranties/claims for defects on account of possible variations of the actual qualities from the qualities described herein are explicitly excluded. All rights reserved. Specifications subject to change without notice!

Date of issue: 19.10.2007 / Page 3 of 5  
 Document : 7100003\_en / Status : 5 / 2691-07

### Latch Contact (Y) / Pressure point (D)

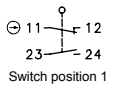
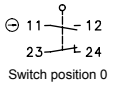
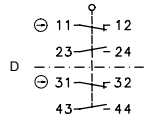
Left pedal (Switching symbol)	Right pedal (Switching symbol)	Contact type	F2 With cover	F2 With protective guard
<p><b>U1ZY</b></p>  <p>Switch position 1</p>  <p>Switch position 0</p> <p>Slow-action contact</p>	<p><b>U2ZD</b></p>  <p>Slow-action contact</p>	<p>2 N.C. 2 N.O. (Zb)</p>	<p>---</p> <p>---</p>	<p>6062620111 F2-U1ZY/U2ZD UN</p>

Switch position 1: normally closed contact: closed, Make contact: open (self-holding contact)

Switch position 0: normally closed contact: open, Make contact: closed (self-holding contact)

This document will not become the contractual basis; the details included herein do not constitute any descriptions of expected conditions, so that warranties/claims for defects on account of possible variations of the actual qualities from the qualities described herein are explicitly excluded. All rights reserved. Specifications subject to change without notice!

Date of issue: 19.10.2007 / Page 4 of 5  
Document : 7100003\_en / Status : 5 / 2691-07

### General data

Electrical data		
Rated insulation voltage	$U_i$	400 VAC
Conv. thermal current	$I_{the}$	10 A
Rated operational voltage	$U_e$	240 V
Utilization category		AC-15, $U_e/I_e$ 240 V / 3 A
Zwangsöffnung	⊖	nach IEC/EN 60947-5-1, Anhang K (pedal stop)
Short-circuit protective device		Fuse 10 A gL/gG (slow-action contact) Fuse 2 A gL/gG (snap-action contact)
Protection class		I

Mechanical Data	
Enclosure	AL
Cover	AL
Protective guard (Accident protection cover UN)	AL
Actuator	Foot lever (PA)
Ambient air temperature	-30 °C ... +80 °C
Operating force (standard)	≈ 10 N (pedal centre)
Mechanical life	10 x 10 <sup>6</sup> switching cycles
Switching frequency	≤ 50/min
Assembly	2 x M8
Connection	Screw connections (M3,5)
Protection ground	2 x M4
Conductor cross-sections	Solid: 0,5 ... 1,5mm <sup>2</sup> Litz wire with ferrules: 0,5 ... 1,5mm <sup>2</sup>
Cable entry	1 x M20x1,5
Weight including cover	≈ 1,7 kg
Weight including protective guard	≈ 2,6 kg
Protection type	IP65 acc. to IEC/EN 60529

<b>Standards</b>	VDE 0660 T100, DIN EN 60947-1, IEC 60947-1 VDE 0660 T200, DIN EN 60947-5-1, IEC 60947-5-1
------------------	--

<b>EU Conformity</b>	CE
----------------------	----

Approvals	
	BG
	cCSA <sub>US</sub> A300, Q300 (same polarity)

**Notes**  
Tapped holes not in use must be closed with blind plugs. The degree of protection (IP code) specified applies only to a properly closed cover and in connection with the appropriate cable glands or blind plugs.