

**Pneumatic Profile Cylinders
ISO 6431, VDMA 24562 and NFE 49-003-1
Non-magnetic and Magnetic Piston
Double Acting
Ø 32 to 125 mm**

- Profile barrel with concealed tie rods
- M/50 – Switches can be mounted flush with the profile
- Conforms to ISO 6431, VDMA 24562 and NFE 49-003-1
- Polyurethane seals ensure efficient low friction operation and long life
- High performance, stability and reliability – ideal for the demands of today
- Supplied complete with piston rod locknut
- Comprehensive range of standard mountings



Technical Data

Medium:

Compressed air, filtered, lubricated or non-lubricated

Standard:

ISO 6431, VDMA 24562 and NFE 49-003-1

Operation:

PRA/182000 Double acting, adjustable cushioning

PRA/182000/M Double acting, magnetic piston, adjustable cushioning

Operating Pressure:

1 to 16 bar

Operating Temperature:

-20°C* to +80°C max.

High temperature versions: 150°C max.

*Consult our Technical Service for use below +2°C

Cylinder Diameters:

32, 40, 50, 63, 80, 100, 125 mm

Strokes:

Standard: see page N 1.5.135.02

Non-standard strokes available (10 to 3000 mm)

Materials:

Profile barrel: Anodised aluminium

End covers: Pressure diecast aluminium

Piston rod: Stainless steel (Martensitic)

Piston rod seals: Polyurethane

Piston seals: Polyurethane

'O'-rings: Nitrile rubber

Ordering Examples

See page N 1.5.135.04

Mountings and Switches

See page N 1.5.135.03 and .04

Guide Blocks

QA/8000/51/* – Plain Bearing

QA/8000/61/* – Roller Bearing (long coupling)

QA/8000/81/* – Plain Bearing (long coupling)

QA/8000/85/* – Plain Bearing (short coupling)

See page N 1.5.135.16 to 20

Alternative Models

Single acting cylinders

In Line Positioner Cylinders

Cylinder with positioner

See page

N 1.4.121

N 1.5.125.09+10

N 1.5.125.09+19

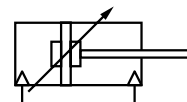

Non-magnetic piston

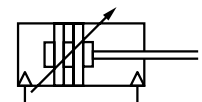

Magnetic piston





Cylinder Variants

Symbol	Model Non-magnetic piston	Symbol	Model Magnetic piston	Description	Dimensions Page
	PRA/182000		PRA/182000/M	Standard cylinder	5
	PCA/182000		PCA/182000/M	Cylinder with hard chromium plated piston rod	5
	PSA/182000		PSA/182000/M	Cylinder with stainless steel piston rod (Austenitic)	5
	PRA/182000/W1		PRA/182000/W2	Cylinder with special wiper/seal (suitable for applications with cement, plaster (stucco), arizona sand, hoar-frost or ice)	5
	PRA/182000/X1		PRA/182000/X2	Low friction cylinders, operating pressure: 1 to 10 bar Medium: Compressed air, filtered and non-lubricated recommended	5
	PRA/182000/IU		T PRA/182000/M	Cylinder with heat resistant seal (150° C max.)	5
	PRA/182000/W5		PRA/182000/MU	Cylinder with extended piston rod	5
	PRA/182000/W6		PRA/182000/W6	Cylinder with extended piston rod and special wiper/seal (suitable for applications with cement, plaster (stucco), arizona sand, hoar-frost or ice)	5
			PRA/182000/MG	Cylinder with piston rod bellows	7
	PRA/182000/W		PRA/182000/MW	Cylinder without cushioning	5
	PRA/182000/X3		PRA/182000/X4	Low friction cylinders without cushioning, operating pressure: 1 to 10 bar Medium: Compressed air, filtered or non-lubricated recommended	5
	PRA/182000/J		H PRA/182000/M	Cylinder with hydraulic resistant seal (∅ 32 to 100 mm)	5
			PRA/182000/JM	Cylinder with double ended piston rod	6
	PRA/182000/W3		PRA/182000/W4	Cylinder with double ended piston rod and special wiper/seal (suitable for applications with cement, plaster (stucco), arizona sand, hoar-frost or ice)	5
	PRA/182000/IT		PRA/182000/MT	Four-position cylinders	6
	PRA/182000/N1		PRA/182000/N2	Cylinder with non-rotating piston rod, ∅ 32 to 100 mm	6
	PRA/182000/L2		PRA/182000/L4	Cylinder with locking unit (PASSIVE). Locking is achieved by spring force on removal of the signal to the unit. Operating Pressure for locking unit: 4 to 10 bar	7
	PRA/182000/IIL		PRA/182000/MIL	Cylinder barrel turned at 90° for use with guide blocks QA/8000/51/* and QA/8000/61/*	15, 16, 17

For combinations of cylinder variants consult our Technical Service.

Standard Strokes

Cylinder ∅	Strokes (mm)										
	25	50	80	100	125	160	200	250	320	400	500
32	●	●	●	●	●	●	●	●	●	●	●
40	●	●	●	●	●	●	●	●	●	●	●
50	●	●	●	●	●	●	●	●	●	●	●
63	●	●	●	●	●	●	●	●	●	●	●
80	●	●	●	●	●	●	●	●	●	●	●
100	●	●	●	●	●	●	●	●	●	●	●
125	●	●	●	●	●	●	●	●	●	●	●



Model Codes

*P*A/182***/***/***/***

Special Variants	Substitute
Heat resistant seals, 150°C max.	T
Hydraulic	H

Piston rod material	Substitute
Stainless steel (Martensitic)	R
Hard chromium plated	C
Stainless steel (Austenitic)	S

Cylinder Diameters (mm)	Substitute
032, 040, 050, 063, 080, 100, 125	

Variants (magnetic piston)	Substitute
Standard	M
Special wiper/seal	W2
Low friction	X2
Piston rod bellow	MG
Without cushioning	MW
Without cushioning, low friction	X4
Double ended piston rod	JM
Double ended piston rod, special wiper/seal	W4
Four-position	MT
Non-rotating piston rod	N2
Locking unit	L4
Barrel turned at 90° for use with guide blocks	MIL
Extended piston rod	MU
Extended piston rod, special wiper/seal	W6
P*A/182***/MU****/***	
/W6/	→ Extension (mm)

Strokes (mm)
3000 max.

Variants (non-magnetic piston)	Substitute
Standard	None
Special wiper/seal	W1
Low friction	X1
Piston rod bellow	G
Without cushioning	W
Without cushioning, low friction	X3
Double ended piston rod	J
Double ended piston rod, special wiper/seal	W3
Four-position	IT
Non-rotating piston rod	N1
Locking unit	L2
Barrel turned at 90° for use with guide blocks	IIL
Extended piston rod	IU
Extended piston rod, special wiper/seal	W5
P*A/182***/IU****/***	
/W5/	→ Extension (mm)

Note: If option is not required, disregard option position within part number eg. PRA/182100/100. For combinations of cylinder variants consult our Technical Service.

Switches

	Cable	Plug (M8x1)	Cable (150°C max.)
Model			
Reed	M/50/LSU/.. M/50/RAC/5V	M/50/LSU/CP —	TM/50/RAU/2S —
Solid state	M/50/EAP/.. M/50/EAN/..	M/50/EAP/CP M/50/EAN/CP	— —



























Model	Reed	Solid State	Voltage		Current Max.	Temperature °C	LED	Features	Cable/Plug Length	Cable Type	Plug-in Cable		Catalogue Page
			V a.c.	V d.c.							Straight	90°	
M/50/LSU/*V	—	—	10 to 240	10 to 170	180 mA	-20° to +80°	●	—	2, 5, 10 m	PVC 2 x 0,25	—	—	N 4.3.005
M/50/LSU/5U	—	—	10 to 240	10 to 170	180 mA	-20° to +80°	●	—	5 m	PUR 2 x 0,25	—	—	N 4.3.005
TM/50/RAU/2S	—	—	10 to 240	10 to 170	180 mA	-20° to +150°	—	—	2 m	Silicon 2 x 0,25	—	—	N 4.3.005
M/50/RAC/5V	—	—	10 to 240	10 to 170	180 mA	-20° to +80°	—	Changeover	5 m	PVC 3 x 0,25	—	—	N 4.3.005
M/50/LSU/CP	—	—	10 to 60	10 to 75	180 mA	-20° to +80°	●	Plug M8x1	5 m	PVC 3 x 0,25	M/P73001/5	—	N 4.3.005
—	—	M/50/EAP/*V	—	10 to 30	150 mA	-20° to +80°	●	PNP	2, 5, 10 m	PVC 3 x 0,25	—	—	N 4.3.007
—	—	M/50/EAP/CP	—	10 to 30	150 mA	-20° to +80°	●	PNP, plug M8x1	5 m	PVC 3 x 0,25	M/P73001/5	—	N 4.3.007
—	—	M/50/EAN/*V	—	10 to 30	150 mA	-20° to +80°	●	NPN	2, 5, 10 m	PVC 3 x 0,25	—	—	N 4.3.007
—	—	M/50/EAN/CP	—	10 to 30	150 mA	-20° to +80°	●	NPN, plug M8x1	5 m	PVC 3 x 0,25	M/P73001/5	—	N 4.3.007

* Insert cable length

Full information on switches (technical data, cable materials, dimensions etc.) please refer to relevant catalogue pages



Mountings

Cylinder Ø	Style 'A'	Style 'AK'	Style 'B', 'G'	Style 'C'	Style 'D'	Style 'D2'	Style 'F'	Style 'FH'	Style 'L'
	 Page 08	 Page 14	 Page 08	 Page 08	 Page 10	 Page 11	 Page 09	 Page 13	 Page 10
32	QM/8032/35	QM/8025/38	QA/8032/22	QA/8032/21	QA/8032/23	QA/8032/42	QM/8025/25	QA/8032/34	QA/8032/24
40	QM/8032/35	QM/8040/38	QA/8040/22	QA/8040/21	QA/8040/23	QA/8040/42	QM/8040/25	QA/8040/34	QA/8040/24
50	QM/8050/35	QM/8050/38	QA/8050/22	QA/8050/21	QA/8050/23	QA/8050/42	QM/8050/25	QA/8050/34	QA/8050/24
63	QM/8050/35	QM/8050/38	QA/8063/22	QA/8063/21	QA/8063/23	QA/8063/42	QM/8050/25	QA/8063/34	QA/8063/24
80	QM/8080/35	QM/8080/38	QA/8080/22	QA/8080/21	QA/8080/23	QA/8080/42	QM/8080/25	QA/8080/34	QA/8080/24
100	QM/8080/35	QM/8080/38	QA/8100/22	QA/8100/21	QA/8100/23	QA/8100/42	QM/8080/25	QA/8100/34	QA/8100/24
125	QM/8125/35	QM/8125/38	QA/8125/22	QA/8125/21	QA/8125/23	QA/8125/42	QM/8125/25	QA/8125/34	QA/8125/24
Cylinder Ø	Style 'M'	Style 'R'	Style 'S'	Style 'SS'	Style 'SW'	Style 'UF'	Style 'UH'	Style 'UL'	Style 'UR'
	 Page 09	 Page 12	 Page 13	 Page 09	 Page 10	 Page 14	 Page 13	 Page 11	 Page 12
32	QM/8032/26	QA/8032/27	QA/8032/41	M/P19931	M/P19493	QM/8025/32	PQA/182032/40	QA/8032/43	QA/8032/33
40	QM/8040/26	QA/8040/27	QA/8040/41	M/P19932	M/P19494	QM/8040/32	PQA/182040/40	QA/8040/43	QA/8040/33
50	QM/8050/26	QA/8050/27	QA/8040/41	M/P19933	M/P19495	QM/8050/32	PQA/182050/40	QA/8050/43	QA/8050/33
63	QM/8063/26	QA/8063/27	QA/8063/41	M/P19934	M/P19496	QM/8050/32	PQA/182063/40	QA/8063/43	QA/8063/33
80	QM/8080/26	QA/8080/27	QA/8063/41	M/P19935	M/P19497	QM/8080/32	PQA/182080/40	QA/8080/43	QA/8080/33
100	QM/8100/26	QA/8100/27	QA/8100/41	M/P19936	M/P19498	QM/8080/32	PQA/182100/40	QA/8100/43	QA/8100/33
125	QM/8125/26	QA/8125/27	QA/8100/41	M/P19937	M/P19499	QM/8125/32	PQA/182125/40	QA/8125/43	QA/8125/33
Cylinder Ø	Style 'US'	Guide Blocks Plain Bearing	Guide Blocks ## Roller Bearing (long coupling)	Guide Blocks Plain Bearing (long coupling)	Guide Blocks Plain Bearing (short coupling)	Locking Unit #	Valve Mounting Kit	Groove Key	Groove Cover
	 Page 11	 Page 20	 Page 16	 Page 18	 Page 18	 Page 07	 Page 15	 Page 15	 Page 15
32	M/P40310	QA/8032/51/*	QA/8032/61/*	QA/8032/81/*	QA/8032/85/*	QA/8032/59	-	M/P72816	M/P72725/1000
40	M/P40311	QA/8040/51/*	QA/8040/61/*	QA/8040/81/*	QA/8040/85/*	QA/8040/59	-	M/P72816	M/P72725/1000
50	M/P40312	QA/8050/51/*	QA/8050/61/*	QA/8050/81/*	QA/8050/85/*	QA/8050/59	QA/180050/22/54	M/P72816	M/P72725/1000
63	M/P40313	QA/8063/51/*	QA/8063/61/*	QA/8063/81/*	QA/8063/85/*	QA/8063/59	QA/180050/22/54	M/P72816	M/P72725/1000
80	M/P40314	QA/8080/51/*	QA/8080/61/*	QA/8080/81/*	QA/8080/85/*	QA/8080/59	QA/180080/22/54	M/P72816	M/P72725/1000
100	M/P40315	QA/8100/51/*	QA/8100/61/*	QA/8100/81/*	QA/8100/85/*	QA/8100/59	QA/180080/22/54	M/P72816	M/P72725/1000
125	M/P71355	-	-	-	-	QA/8125/59	QA/180080/22/54	M/P72816	M/P72725/1000

* Insert standard stroke length (50, 100, 160, 200, 250, 320, 400, or 500) in mm. Consult our Technical Service for stroke lengths above 500 mm.

For locking cartridge see page 07

For locking cartridge see page 16

Ordering Examples

Cylinders

To order a standard 80 mm bore magnetic piston cylinder with a 50 mm stroke quote: **PRA/182080/M/50**

Switches

To order a reed switch with LED and 2 m cable length quote: **M/50/LSU/2V**

Mountings

To order a front flange mounting style 'G' for 80 mm bore cylinder quote: **QA/8080/22**



Theoretical Forces • Cushioning • Air Consumption

Cylinder Ø	Theoretical forces (N) at 6 bar		Cushion length (mm)	Initial cushion volume (cm ³)	Air consumption (l/cm stroke) at 6 bar	
	Outstroke	Instroke			Outstroke	Instroke
32	482	414	19	12,3	0,056	0,048
40	754	633	22	20,7	0,088	0,074
50	1178	990	24	36	0,137	0,114
63	1870	1680	24	64	0,218	0,195
80	3016	2722	27	116	0,35	0,32
100	4710	4416	34	242	0,55	0,51
125	7363	6882	41	451	0,86	0,79

Basic Dimensions

PRA/182000, PRA/182000/M — Standard Cylinders

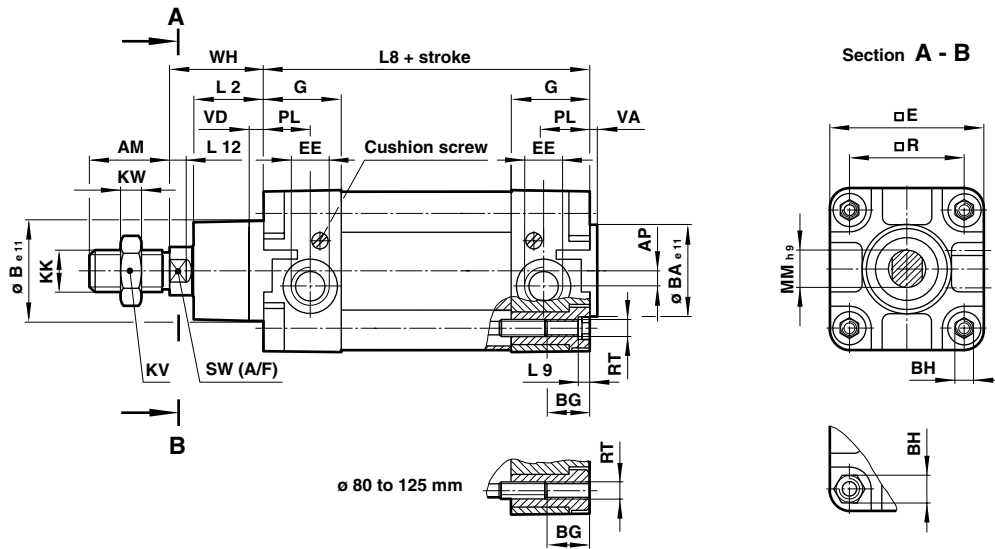

Cylinder Ø	AM	AP	Ø B e 11	Ø BA e 11	BG	BH (A/F)	□ E	EE	G	KK	KV (A/F)	KW	L2
32	22	3,5	30	30	18	6	47	G 1/8	27,5	M10x1,25	17	5	20
40	24	4,5	35	35	18	6	53	G 1/4	32	M12x1,25	19	6	22
50	32	6	40	40	18	8	65	G 1/4	31	M16x1,5	24	8	27
63	32	10	45	45	17,5	8	75	G 3/8	33	M16x1,5	24	8	29
80	40	8,5	45	45	21,5	19	95	G 3/8	33	M20x1,5	30	10	33
100	40	9	55	55	21,5	19	115	G 1/2	37	M20x1,5	30	10	36
125	54	10	60	60	32	24	140	G 1/2	46	M27x2	41	13,5	45

Cylinder Ø	L8	L9	L12	Ø MM h 9	PL	□ R	RT	SW (A/F)	VA	VD	WH	at 0 mm	per 25 mm
32	94	4	6	12	13	32,5	M 6	10	3	6	26	0,51 kg	0,06 kg
40	105	4	6,5	16	15	38	M 6	13	3,5	6	30	0,80 kg	0,08 kg
50	106	5	8	20	18,5	46,5	M 8	17	3,5	6	37	1,33 kg	0,12 kg
63	121	5	8	20	19	56,5	M 8	17	4	6	37	1,80 kg	0,13 kg
80	128	-	10	25	19	72	M 10	22	4	6	46	3,25 kg	0,20 kg
100	138	-	10	25	18	89	M 10	22	4	6	51	4,81 kg	0,23 kg
125	160	-	13	32	20	110	M 12	27	6	15,5	65	8,00 kg	0,33 kg



Cylinder Variants

PRA/182000/J, PRA/182000/JM – Cylinders with Double Ended Piston Rod

Cylinder Ø	ZM	L8
32	146	94
40	165	105
50	180	106
63	195	121
80	220	128
100	240	138
125	290	160

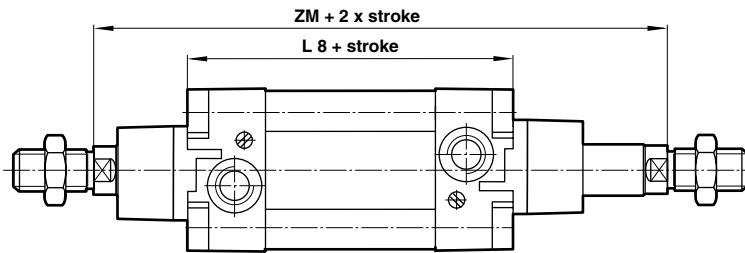

PRA/182000/N1, PRA/182000/N2 – Cylinders with Non-Rotating Piston Rod

Cylinder Ø	SW1 (A/F)
32	10
40	13
50	16
63	16
80	21
100	21

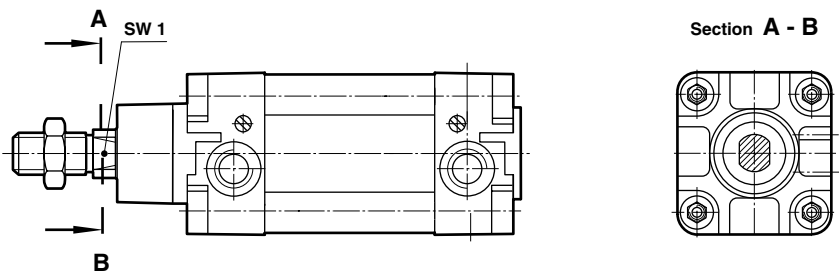

Torque

Cylinder Ø	Torque max. (Nm)
32	0,5
40	1,0
50	1,5
63	1,5
80	2,5
100	2,5

PRA/182000/IT, PRA/182000/MT – Four-position Cylinders

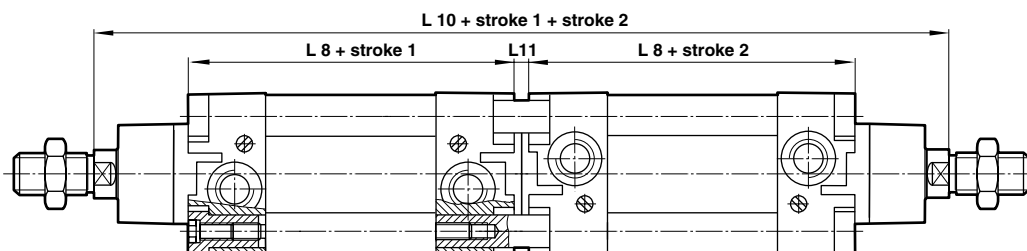

Cylinder Ø	L 8	L 10	L 11
32	94	247	7
40	105	278	8
50	106	294	8
63	121	325	9
80	128	357	9
100	138	387	9
125	160	462	12



PRA/182000/G, PRA/182000/MG – Cylinders with Piston Rod Bellows

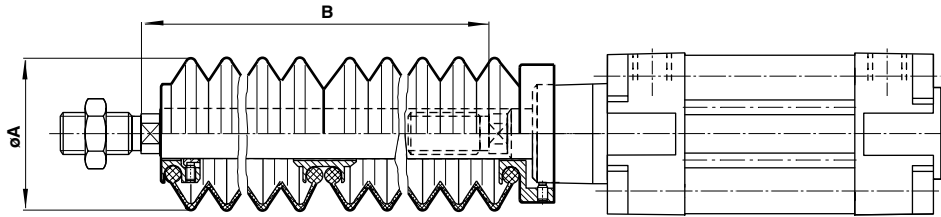

Cylinder \varnothing	$\varnothing A$	Maximum stroke per bellow	Piston rod extension B	
			first bellow	further bellows
32	40	60	30	25
40	63	145	50	32
50	63	145	40	32
63	63	145	40	32
80	80	250	50	45
100	80	250	50	45
125	80	250	50	45

PRA/182000/L2, PRA/182000/L4 – Cylinders with Locking Unit (Passive)

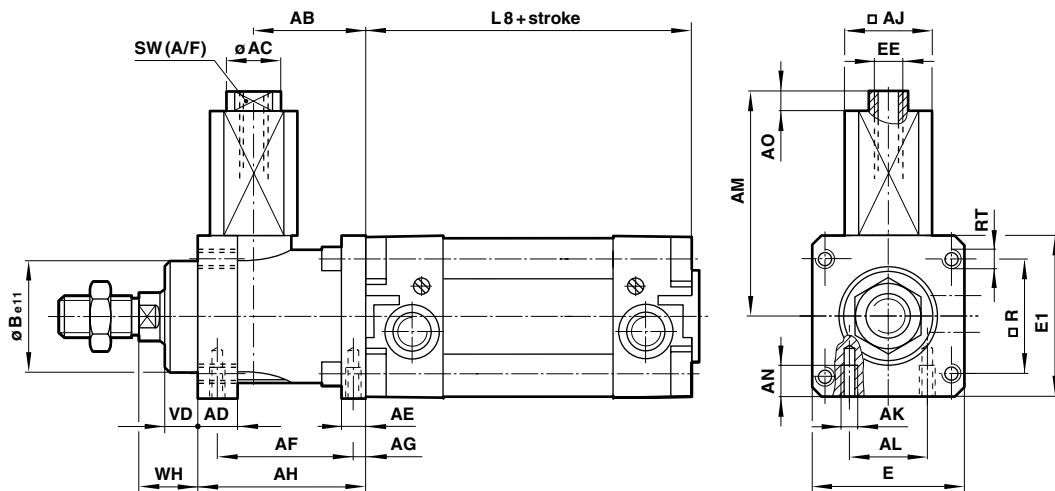

Cylinder \varnothing	AB	$\varnothing AC$	AD	AE	AF	AG	AH	$\square AJ$	AK	AL	AM	AN
32	32	10	12	8	40	4,2	48	22,7	M 5	16	70,5	8
40	35,5	10	12	10	46	4,5	55	27,7	M 5	21	74,5	10
50	49	15	16	15	54	11,5	70	32,7	M 6	24	91,5	12
63	49	15	15	15	55	7,5	70	41	M 8	32	108,5	12
80	62	19	16	16	70	10	90	53	M 8	44	141,5	16
100	65	19	18	16	70	10	92	53	M 8	60	141,5	16
125	85	19	27	25	95	11	122	64,9	M 10	75	152	20

Cylinder \varnothing	A0	$\varnothing B_{e11}$	E	E 1	EE	L 8	$\square R$	RT	SW (A/F)	VD	WH	Forces *
32	4	30	48	50	M 5	94	32,5	M 6	8	10	16	600 N
40	4	35	56	58	M 5	105	38	M 6	8	10	18	1000 N
50	4	40	68	70	G 1/8	106	46,5	M 8	13	12	22	1500 N
63	4	45	82	85	G 1/8	121	56,5	M 8	13	12	20	2200 N
80	4	45	100	105	G 1/8	128	72	M 10	17	20	33	5000 N
100	4	55	120	130	G 1/8	138	89	M 10	17	23	38	5000 N
125	4	60	140	150	G 1/8	160	110	M 12	17	32	65	7000 N

Separate Locking Cartridge

Cylinder \varnothing	Model	Forces *
32	QA/8032/63	600 N
40	QA/8040/63	1000 N
50	QA/8050/63	1500 N
63	QA/8063/63	2200 N
80	QA/8100/63	5000 N
100	QA/8100/63	5000 N
125	QA/8125/63	7000 N

* Retention forces



Mountings

QM/8000/35 – Front or Rear Stud Mounting Style ‘A’ (Corresponds to DIN ISO 6431, Style MX1)

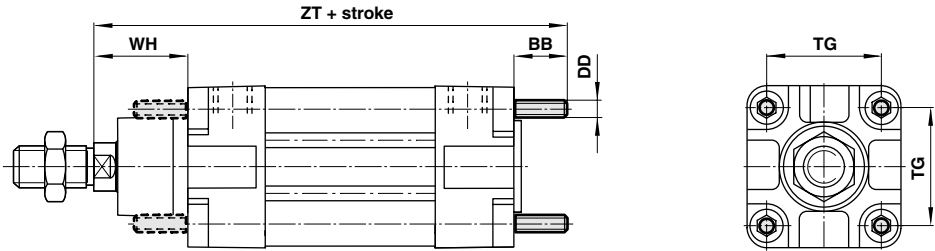

Q./8000/22 – Rear Flange Mounting Style ‘B’ (Corresponds to DIN ISO 6431 and VDMA 24562 Part 2, Style MF2)

Q./8000/22 – Front Flange Mounting Style ‘G’ (Corresponds to DIN ISO 6431 and VDMA 24562 Part 2, Style MF1)

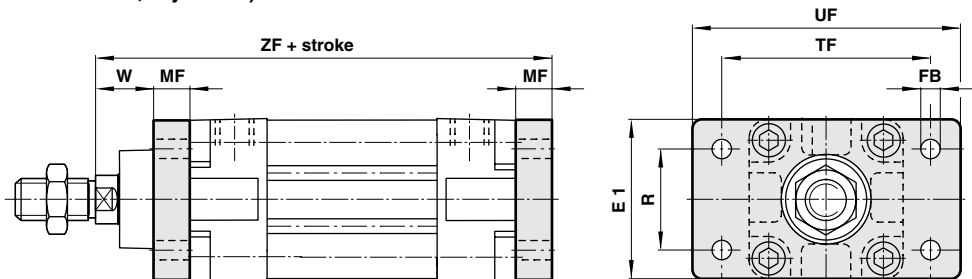

Q./8000/21 – Foot Mounting Style ‘C’ (Corresponds to DIN ISO 6431 and VDMA 24562 Part 2, Style MS1)

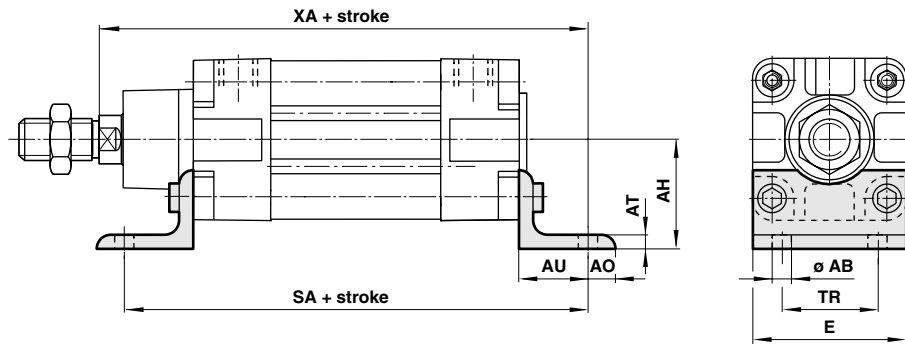

Cylinder \varnothing	\varnothing AB	AH	A0	AT	AU	BB	DD	E	E1	\varnothing FB	MF	R	SA
32	7	32	8	4	24	17	M 6	48	50	7	10	32	142
40	9	36	9	4	28	17	M 6	53	55	9	10	36	161
50	9	45	10	5	32	23	M 8	64	65	9	12	45	170
63	9	50	12	5	32	23	M 8	74	75	9	12	50	185
80	12	63	19	5	41	28	M 10	98	100	12	16	63	210
100	14	71	19	5	41	28	M 10	115	120	14	16	75	220
125	16	90	20	9	45	34	M 12	140	140	16	20	90	250

Cylinder \varnothing	TF	\square TG	TR	UF	W	WH	XA	ZF	ZT	Style ‘A’	Style ‘B’, ‘G’	Style ‘C’
32	64	32,5	32	80	16	26	144	130	137	0,02 kg	0,25 kg	0,15 kg
40	72	38	36	90	20	30	163	145	152	0,02 kg	0,35 kg	0,18 kg
50	90	46,5	45	110	25	37	175	155	166	0,05 kg	0,70 kg	0,30 kg
63	100	56,5	50	125	25	37	190	170	181	0,05 kg	0,80 kg	0,39 kg
80	126	72	63	154	30	46	215	190	202	0,08 kg	1,35 kg	0,80 kg
100	150	89	75	186	35	51	230	205	217	0,08 kg	2,20 kg	0,95 kg
125	180	110	90	224	45	65	270	245	259	0,14 kg	1,70 kg	2,40 kg



QM/8000/25 – Piston Rod Clevis Mounting Style ‘F’
(Corresponds to DIN ISO 8140)

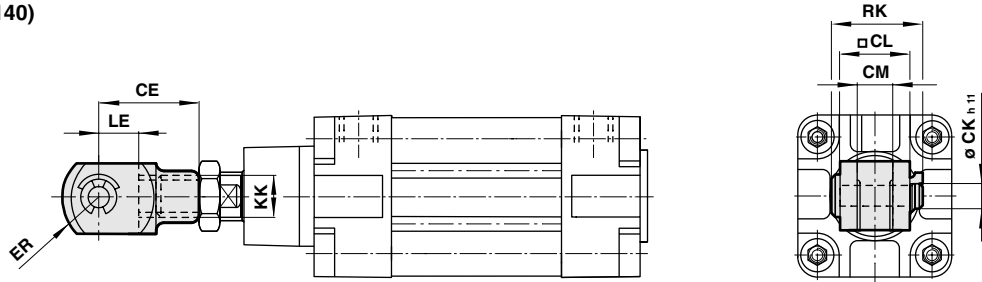

QM/8000/26 – Front Hinge Mounting Style ‘M’

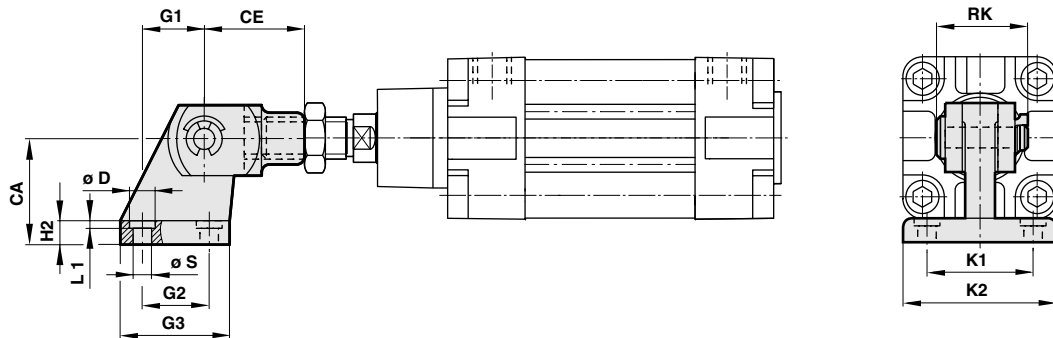

M/P199 . . – Bracket for Clevis Mounting Style ‘SS’

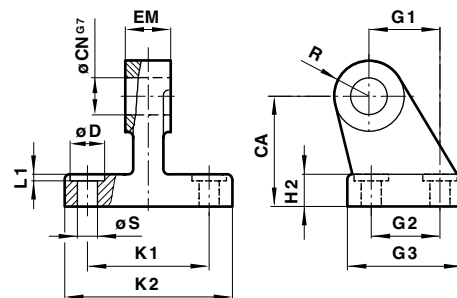

Cylinder Ø	CA	CE	Ø CK h11	CL	CM	Ø CN G7	Ø D	EM	ER	G 1	G 2	G 3
32	32	40	10	20	10	10	11	10	16	21	18	31
40	36	48	12	24	12	12	11	12	19	24	22	35
50	45	64	16	32	16	16	15	16	25	33	30	45
63	50	64	16	32	16	16	15	16	25	37	35	50
80	63	80	20	40	20	20	18	20	32	47	40	60
100	71	80	20	40	20	20	18	20	32	55	50	70
125	90	110	30	55	30	30	20	30	45	70	60	90
Cylinder Ø	H 2	KK	K 1	K 2	L1	LE	R	RK	Ø S	Style ‘F’	Style ‘M’	Style ‘SS’
32	8	M10x1,25	38	51	1,6	20	10	28	6,6	0,09 kg	0,24 kg	0,15 kg
40	10	M12x1,25	41	54	1,6	24	11	32	6,6	0,13 kg	0,33 kg	0,20 kg
50	12	M16x1,5	50	65	1,6	32	13	41,5	9	0,33 kg	0,81 kg	0,48 kg
63	12	M16x1,5	52	67	1,6	32	15	41,5	9	0,33 kg	0,83 kg	0,50 kg
80	14	M20x1,5	66	86	2,5	40	15	50	11	0,67 kg	1,42 kg	0,75 kg
100	15	M20x1,5	76	96	2,5	40	19	50	11	0,67 kg	1,87 kg	1,20 kg
125	20	M27x2	94	124	3,2	54	22	62	14	1,35 kg	3,85 kg	2,50 kg



Q./8000/23 – Rear Clevis Mounting Style ‘D’

(Corresponds to DIN ISO 6431 and VDMA 24562 Part 2, Style MP2)

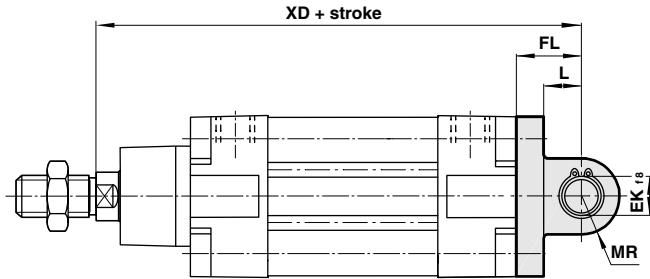
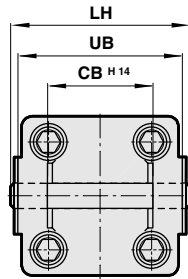

Q./8000/24 – Rear Hinge Mounting Style ‘L’

(Corresponds to VDMA 24562 Part 2)

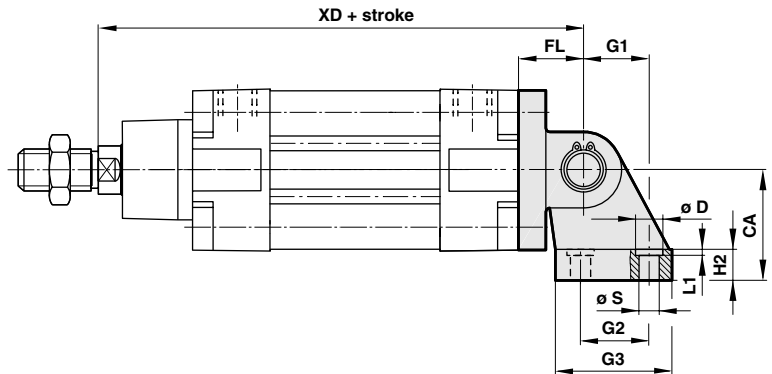
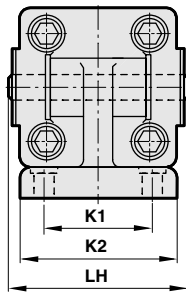

M/P194 . . – Bracket for Clevis Mounting (wide clevis) Style ‘SW’

(Corresponds to VDMA 24562, Part 2)

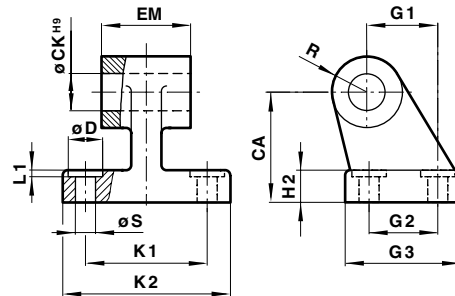

Cylinder \varnothing	CA	CB H ¹⁴	\varnothing CK H ⁹	\varnothing D	\varnothing EK 18	EM	FL	G 1	G 2	G 3	H 2	K 1
32	32	26	10	11	10	26	22	21	18	31	8	38
40	36	28	12	11	12	28	25	24	22	35	10	41
50	45	32	12	15	12	32	27	33	30	45	12	50
63	50	40	16	15	16	40	32	37	35	50	12	52
80	63	50	16	18	16	50	36	47	40	60	14	66
100	71	60	20	18	20	60	41	55	50	70	15	76
125	90	70	25	20	25	70	50	70	60	90	20	94

Cylinder \varnothing	K 2	L	L 1	LH	MR	R	\varnothing S	UB	XD	Style ‘D’	Style ‘L’	Style ‘SW’
32	51	13	1,6	52	9	10	6,6	45	142	0,11 kg	0,16 kg	0,05 kg
40	54	16	1,6	60	12	11	6,6	52	160	0,16 kg	0,23 kg	0,07 kg
50	65	17	1,6	68	12	13	9	60	170	0,22 kg	0,36 kg	0,14 kg
63	67	22	1,6	79	15	15	9	70	190	0,34 kg	0,52 kg	0,18 kg
80	86	22	2,5	99	15	15	11	90	210	0,54 kg	0,82 kg	0,28 kg
100	96	27	2,5	119	20	19	11	110	230	0,90 kg	1,32 kg	0,42 kg
125	124	31	3,2	139	25	22	14	130	275	2,70 kg	5,40 kg	2,70 kg



QA/8000/42 – Rear Clevis Mounting Style ‘D2’
(Corresponds to VDMA 24562 Part 2)

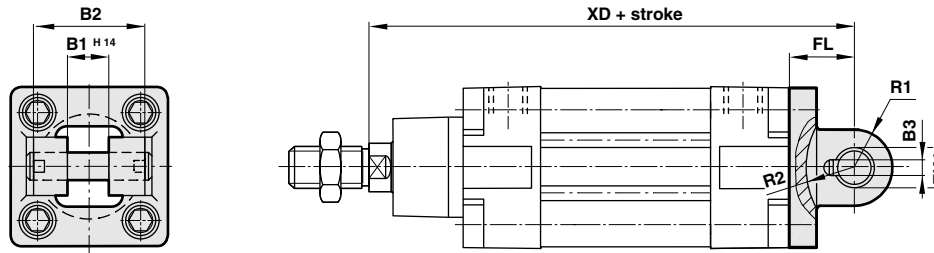

QA/8000/43 – Universal Rear Hinge Mounting Style ‘UL’
(Corresponds to VDMA 24562 Part 2)

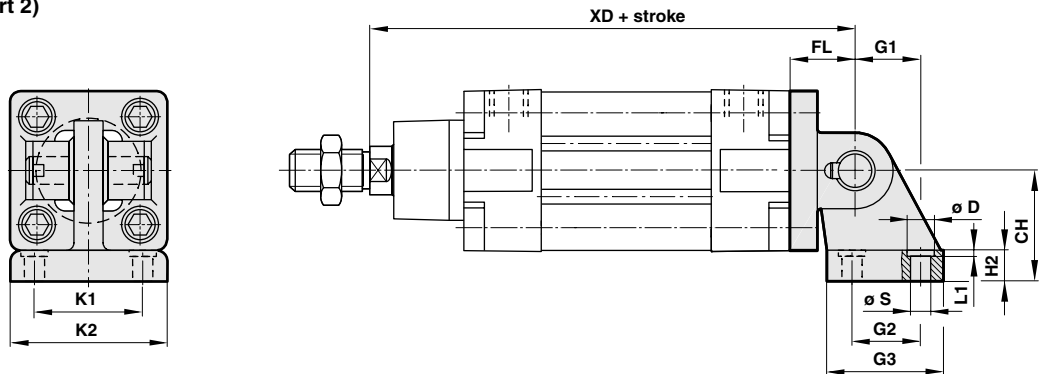

M/P403 . . – Bracket Hinge for Clevis Mounting Style ‘US’
(Corresponds to VDMA 24562 Part 2)

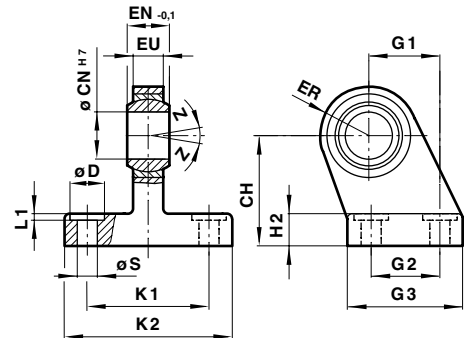

Cylinder Ø	B1 H14	B2	B3	CH	Ø CN H7	Ø D	Ø EK h9	EN -0,1	ER	EU	FL	G 1	G 2
32	14	34	3,3	32	10	11	10	14	16	10,5	22	21	18
40	16	40	4,3	36	12	11	12	16	19	12	25	24	22
50	21	45	4,3	45	16	15	16	21	21	15	27	33	30
63	21	51	4,3	50	16	15	16	21	24	15	32	37	35
80	25	65	4,3	63	20	18	20	25	28	18	36	47	40
100	25	75	4,3	71	20	18	20	25	30	18	41	55	50
125	37	97	6,3	90	30	20	30	37	40	25	50	70	60
Cylinder Ø	G 3	H 2	K1	K 2	L1	R1	R2	Ø S	XD	Z	Style 'D2'	Style 'UL'	Style 'US'
32	31	8	38	51	1,6	11	17	6,6	142	13°	0,20 kg	0,39 kg	0,19 kg
40	35	10	41	54	1,6	12	20	6,6	160	13°	0,23 kg	0,47 kg	0,24 kg
50	45	12	50	65	1,6	14,5	22	9	170	13°	0,36 kg	0,82 kg	0,46 kg
63	50	12	52	67	1,6	18	25	9	190	15°	0,55 kg	1,14 kg	0,59 kg
80	60	14	66	86	2,5	22	30	11	210	15°	0,90 kg	1,93 kg	1,03 kg
100	70	15	76	96	2,5	22	32	11	230	15°	1,45 kg	2,85 kg	1,40 kg
125	90	20	94	124	3,2	30	42	14	275	15°	2,70 kg	5,80 kg	3,10 kg



Q./8000/27 – Rear Eye Mounting Style ‘R’
(Corresponds to DIN ISO 6431 and VDMA 24562 Part 2, Style MP4)

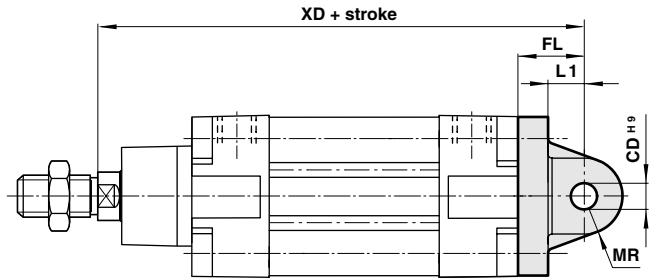
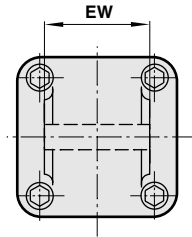

Q./8000/33 – Universal Rear Eye Mounting Style ‘UR’
(Corresponds to VDMA 24562 Part 2)

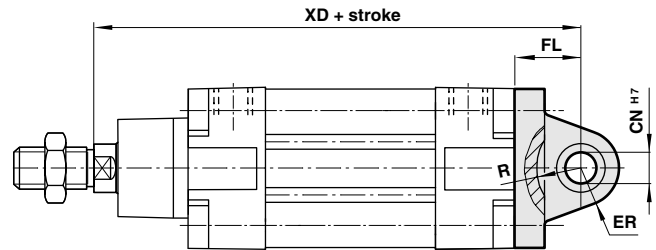
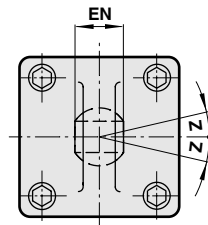

Cylinder \varnothing	\varnothing CD H9	\varnothing CN H7	EN	ER	EW	FL	L1	MR	R	XD	Z	Style 'R'	Style 'UR'
32	10	10	14	16	25,8	22	13	9	14,5	142	13°	0,09 kg	0,17 kg
40	12	12	16	19	27,8	25	16	12	18	160	13°	0,11 kg	0,25 kg
50	12	16	21	21	31,7	27	17	12	19	170	13°	0,17 kg	0,40 kg
63	16	16	21	24	39,7	32	22	15	24	190	15°	0,24 kg	0,55 kg
80	16	20	25	28	49,7	36	22	15	24	210	15°	0,37 kg	0,90 kg
100	20	20	25	30	59,7	41	27	20	29	230	15°	0,59 kg	1,50 kg
125	25	30	37	40	69,7	50	33	25	36	275	15°	3,20 kg	2,70 kg



PQA/182000/40 – Adjustable Trunnion Mounting Style ‘UH’
 (Corresponds to DIN ISO 6431 and VDMA 24562 Part 2, Style MT4)

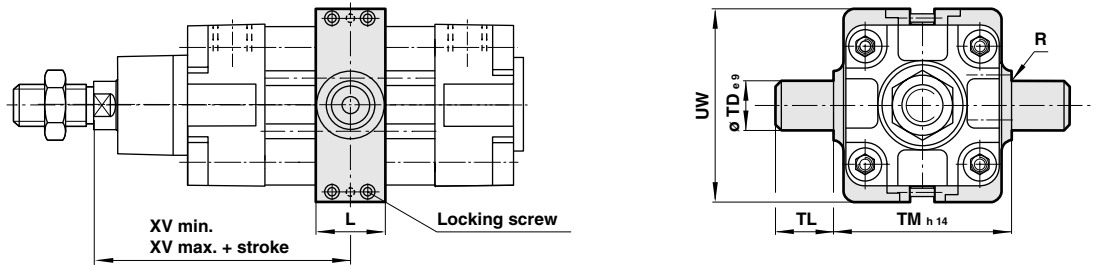

Note:
 Style 'UH': It is most important that the locking screws which secure the mounting to the cylinder barrel are tightened to the torque figures shown in the table below. For maximum energy input, consult our Technical Service.

QA/8000/34 – Front or Rear Detachable Trunnion Mounting Style ‘FH’
 (Corresponds to VDMA 24562 Part 2, Style MT 5/6)

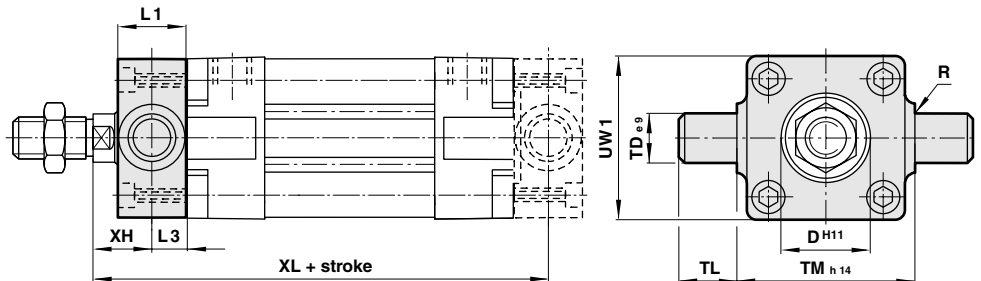

QA/8000/41 – Swivel Bearing Style ‘S’
 For Trunnion Mountings Style ‘FH’, ‘UH’

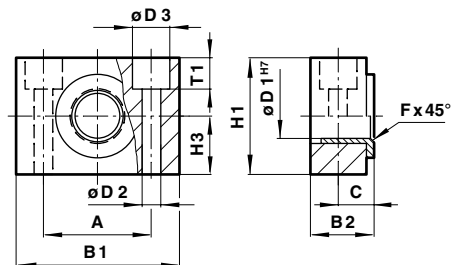

Cylinder Ø	A	B 1	B 2	C	ø D ^{H11}	ø D 1 ^{H7}	ø D 2	ø D 3	F x 45°	H 1	H 3	L	L 1	L 3	R
32	32	46	18	10,5	30	12	6,6	11	1	30	15	25	16	8	1
40	36	55	21	12	35	16	9	15	1,6	36	18	28	20	10	1,6
50	36	55	21	12	40	16	9	15	1,6	36	18	28	24	12	1,6
63	42	65	23	13	45	20	11	18	1,6	40	20	36	24	12	1,6
80	42	65	23	13	45	20	11	18	1,6	40	20	36	28	14	1,6
100	50	75	28,5	16	55	25	14	20	2	50	25	48	38	19	2
125	50	75	28,5	16	60	25	14	20	2	50	25	50	50	25	2

Cylinder Ø	ø TD e9	TL	TM h14	T 1	UW	UW 1	XH	XL	XV min.	XV max.	Torque Nm	Style 'FH'	Style 'S'	Style 'UH'
32	12	12	50	6,8	58	50	18	128	66	80	2	0,20 kg	0,11 kg	0,16 kg
40	16	16	63	9	65	55	20	145	70	89	3,5	0,38 kg	0,16 kg	0,35 kg
50	16	16	75	9	80	65	25	155	82	98	3,5	0,60 kg	0,16 kg	0,65 kg
63	20	20	90	11	96	75	25	170	88	107	5	1,10 kg	0,23 kg	0,85 kg
80	20	20	110	11	116	100	32	188	97	123	6	1,90 kg	0,23 kg	1,20 kg
100	25	25	132	13	140	120	32	208	112	128	6	3,50 kg	0,42 kg	2,30 kg
125	25	25	160	13	163	145	40	250	136	154	6	6,50 kg	0,42 kg	3,30 kg



QM/8000/38 – Piston Rod Swivel Mounting Style ‘AK’

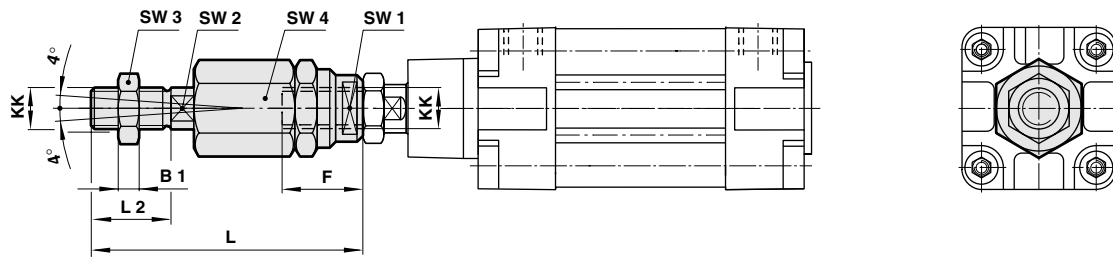

QM/8000/32 – Universal Piston Rod Eye Mounting Style ‘UF’ (Corresponds to DIN ISO 8139)

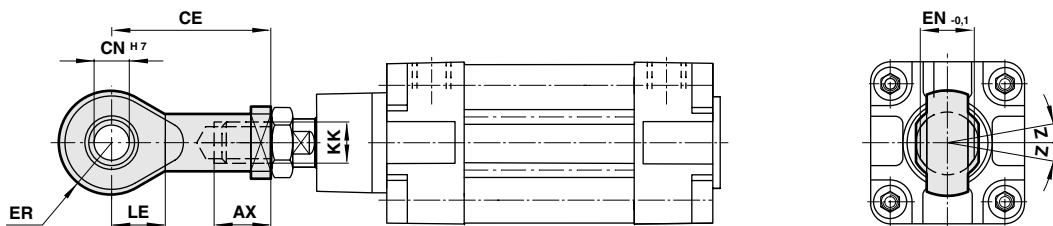

Cylinder \varnothing	AX	B1	CE	\varnothing CN H7	EN -0,1	ER	F	KK	L
32	20	5	43	10	14	14	26	M 10 x 1,25	73
40	22	6	50	12	16	16	26	M 12 x 1,25	77
50	28	8	64	16	21	21	34	M 16 x 1,5	106
63	28	8	64	16	21	21	34	M 16 x 1,5	106
80	33	10	77	20	25	25	42	M 20 x 1,5	122
100	33	10	77	20	25	25	42	M 20 x 1,5	122
125	51	13,5	110	30	37	35	40	M 27 x 2	147
Cylinder \varnothing	L 2	LE	SW 1 (A/F)	SW 2 (A/F)	SW 3 (A/F)	SW 4 (A/F)	Z	Style 'AK'	Style 'F'
32	20	15	19	12	17	30	13°	0,20 kg	0,09 kg
40	24	17	19	12	19	30	13°	0,20 kg	0,13 kg
50	32	22	30	19	24	42	15°	0,65 kg	0,33 kg
63	32	22	30	19	24	42	15°	0,65 kg	0,33 kg
80	40	26	30	19	30	42	15°	0,72 kg	0,67 kg
100	40	26	30	19	30	42	15°	0,72 kg	0,67 kg
125	54	36	40	24	41	55	15°	1,70 kg	1,35 kg



QA/1800.0/22/54 – Valve Mounting Kit

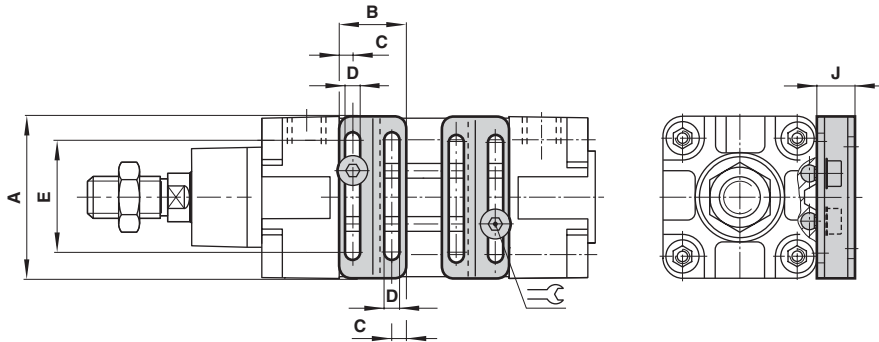

Cylinder Ø	A	B	C	D	E	F	G	H	J	SW	Kit kg
50 + 63	60	37	7	4,5	46	8,5	5,5	2	12	3	0,02
80 – 125	90	37	7	4,5	76	8,5	6,5	2	12	3	0,02

M/P72816 – Groove Key

Weight: 0,010 kg

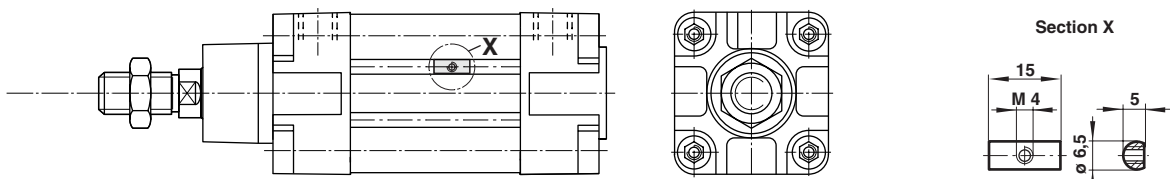

M/P72725/1000 – Groove Cover

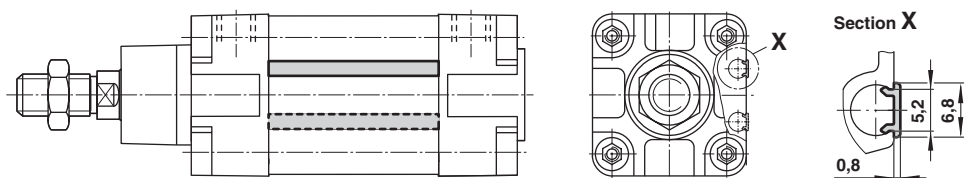



QA/8000/61/* – Guide Blocks with Roller Bearings (long coupling)

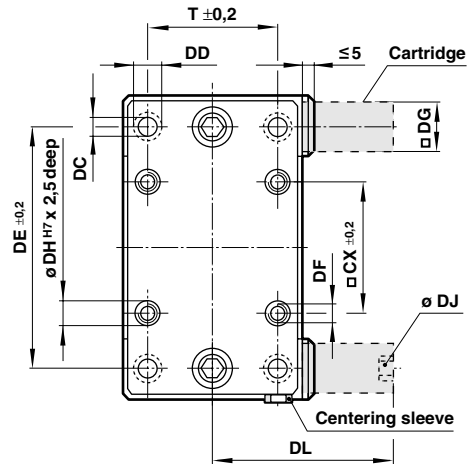
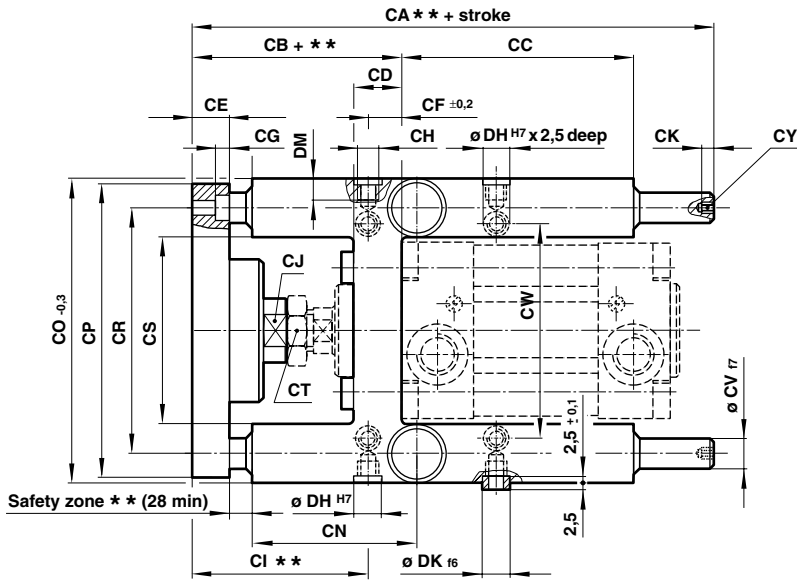

** = Notice adjustment range

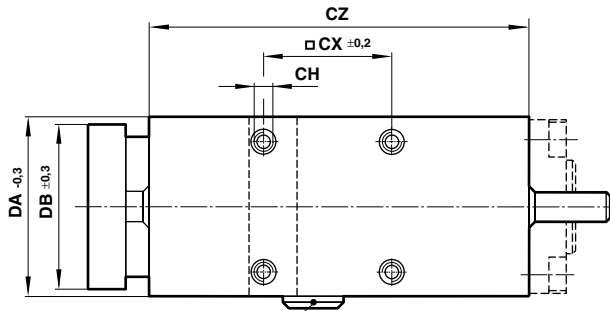

BLANKING PLUG
(remove when using locking cartridge)

Separate Locking Cartridge

Cylinder Ø	Model	Forces *
32	QA/8032/63	600 N
40	QA/8040/63	1000 N
50	QA/8050/63	1500 N
63	QA/8050/63	1500 N
80	QA/8080/63	3000 N
100	QA/8080/63	3000 N

* Retention forces per cartridge

Cylinder Ø	CA**	CB + **	CC	CD	CE	CF ±0,2	CG	CH	CI**	CJ (A/F)	CK	CN	CO -0,3
32	177	100 + 5	65	28	12	15,3	6,5	M6	84,5	13	5	60,5	97
40	192	111 + 5	69	33	12	23	6,5	M6	88	15	6	67	115
50	237	128 + 10	65	40	15	33,8	9	M8	94	22	6	75,5	137
63	237	128 + 10	97	40	15	29,3	9	M8	98,5	22	6	80	152
80	280	151 + 10	112	50	20	37	11	M10	114	27	7	92	189
100	280	156 + 10	112	55	20	40,5	11	M10	115,5	27	7	93	213

Cylinder Ø	CP	CR	CS	CT (A/F)	Ø CV r7	CW	□ CX ±0,2	CY (A/F)	CZ	DA -0,3	DB ±0,3	Ø DC	Ø DD
32	90	74	50,5	17	12	61	32,5	5	125	50	45	6,6	11
40	110	87	58,5	19	16	69	38	6	140	58	54	6,6	11
50	130	104	70,5	24	20	85	46,5	6	150	70	63	9	15
63	145	119	85,5	24	20	100	56,5	6	182	85	80	9	15
80	180	148	105,5	30	25	130	72	8	215	105	100	11	18
100	200	172	130,5	30	25	150	89	8	220	130	120	11	18

Cylinder Ø	DE ±0,2	DF	□ DG	Ø DH H7	DJ	Ø DK r6	DL	DM	T ±0,2	at 0 mm	per 100 mm
32	78	M 6	22,5	9	M 5	9	70,5	14	32,5	1,20 kg	0,18 kg
40	84	M 6	27,5	9	M 5	9	74,5	14	38	2,20 kg	0,32 kg
50	100	M 8	32,5	11	G 1/8	11	91,5	16	46,5	3,60 kg	0,49 kg
63	105	M 8	41	11	G 1/8	11	91,5	16	56,5	4,60 kg	0,49 kg
80	130	M 10	53	13	G 1/8	13	141,5	20	72	8,70 kg	0,77 kg
100	150	M 10	53	13	G 1/8	13	141,5	20	89	11,0 kg	0,77 kg

** Notice adjustment range

Note: Supplied complete with mounting screws for cylinders and two centering sleeves.



Maximum load for QA/8000/61/*

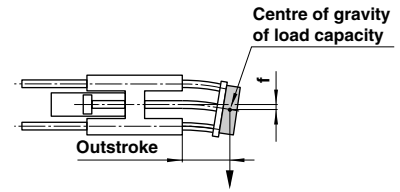
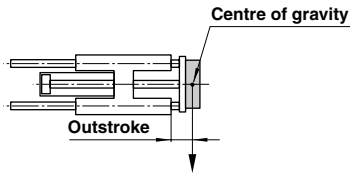

Max. load capacity is dependent on the outstroke of a horizontally installed guide unit. In the case of short stroke operation, the load capacity figures taken from the diagram must be multiplied by the correction factor (diagram 2). In the curves of load capacity (diagram 1), the short stroke corrections have already been taken into account for an outstroke > 60 mm.

The total deflection of guide rods will be determined by the addition of the amount of deflection caused by own weight (according to diagram 3) plus the amount of deflection due to load capacity (according to diagram 4).

Max. load capacity depending on outstroke

(diagram 1)

(diagram 2)

Deflection caused by own weight

(diagram 3)

Deflection caused by a load of 10 N

(diagram 4)

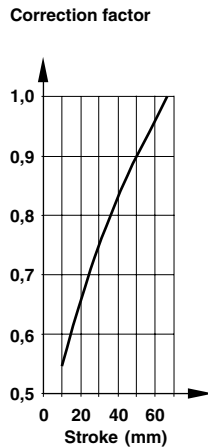
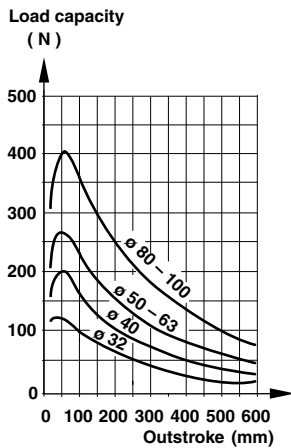

Reduction of load capacity for short-stroke operation

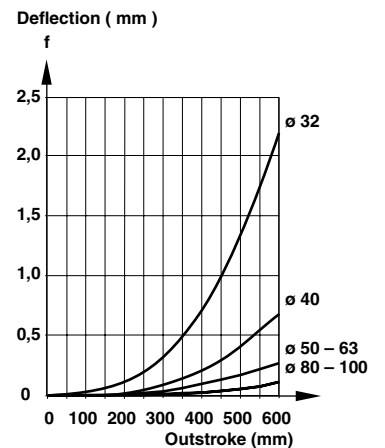
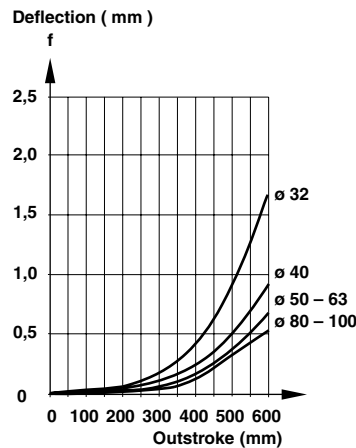

In the case of shock load applications, the figures given in the diagrams above must be reduced by a factor of 2.

Attention:

To use the guide blocks (QA/8000/61) you have to order a cylinder with a barrel which is turned at 90° so that the port threads are in line with the two switch grooves.

Ordering Example:

To order a 40 mm bore magnetic piston cylinder with a 100 mm stroke and the barrel turned at 90° quote: PRA/182040/MIL/100

Non-magnetic version:
PRA/182040/IIL/100



QA/8000/81/* – Guide Blocks with Plain Bearings (long coupling)
QA/8000/85/* – Guide Blocks with Plain Bearings (short coupling)

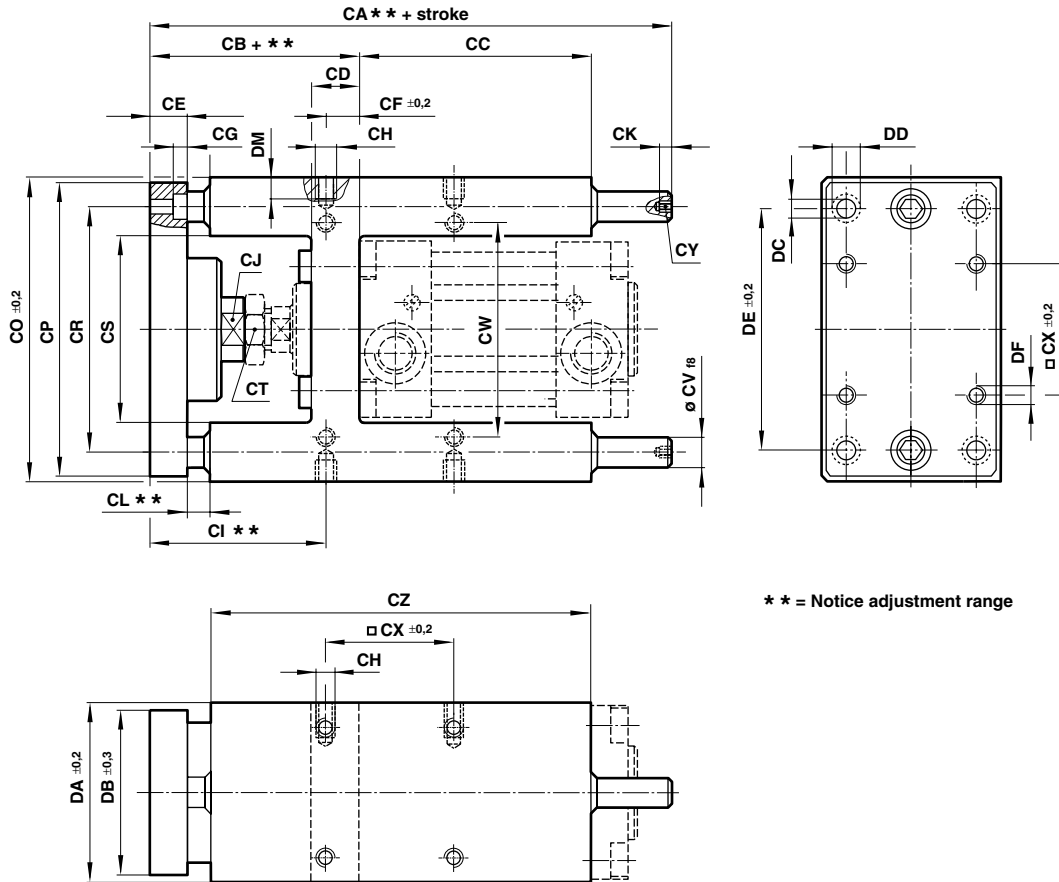

** = Notice adjustment range

Cylinder Ø	CA**/81	CA**/85	CB + **/81	CB + **/85	CC	CD	CE	CF ±0.2	CG	CH	CI**/81	CI**/85
32	174	149	89 + 5	64 + 5	75	24	12	4,3	6,5	M 6	84,7	59,7
40	189	164	99 + 5	74 + 5	80	28	12	11	6,5	M 6	88	63
50	210	181	113 + 10	88 + 10	78	34	15	18,8	8,5	M 8	94,2	69,2
63	235	210	114 + 10	89 + 10	106	34	15	15,3	9	M 8	98,7	73,7
80	265	240	139 + 10	114 + 10	111	50	20	25	11	M 10	114	89
100	288	265	145 + 10	120 + 10	128	55	20	30	11	M 10	115	90

Cylinder Ø	CJ	CK	CL/81	CL/85	CO ±0.2	CP	CR	CS	CT	Ø CV 18	CW	□CX ±0.2
32	15	5	27	2	97	93	74	51	17	12	61	32,5
40	15	6	27	2	115	112	87	58,2	19	16	69	38
50	20	6	28	3	137	134	104	70,2	24	20	85	46,5
63	20	6	27	2	152	147	119	85,2	24	20	100	56,5
80	26	7	35	10	189	180	148	105,5	30	25	130	72
100	26	7	35	10	213	206	173	130,5	30	25	150	89

Cylinder Ø	CY	CZ	DA ±0.2	DB ±0.3	Ø DC	Ø DD	DE ±0.2	DF	DM	at 0 mm/81	at 0 mm/85	per 100 mm
32	5	125	49	45	6,6	11	78	M 6	12	1,20 kg	1,15 kg	0,18 kg
40	6	140	58	55	6,6	11	84	M 6	12	2,20 kg	2,15 kg	0,32 kg
50	6	148	70	65	9	15	100	M 8	16	3,60 kg	3,55 kg	0,49 kg
63	6	178	85	80	9	15	105	M 8	16	4,60 kg	4,55 kg	0,49 kg
80	8	195	105	100	11	18	130	M 10	20	8,70 kg	8,65 kg	0,77 kg
100	8	218	130	120	11	18	150	M 10	20	11,0 kg	10,95 kg	0,77 kg

** Notice adjustment range

Note: Supplied complete with mounting screws for cylinder



Maximum load for QA/8000/81/* and /85/*



Max. load capacity (diagram 1) is dependent on the outstroke of a horizontally installed guide unit.

The total deflection of guide rods will be determined by the addition of the amount of deflection caused by own weight (according to diagram 2) plus the amount of deflection due to load capacity (according to diagram 3).

Max. load capacity depending on outstroke (diagram 1)

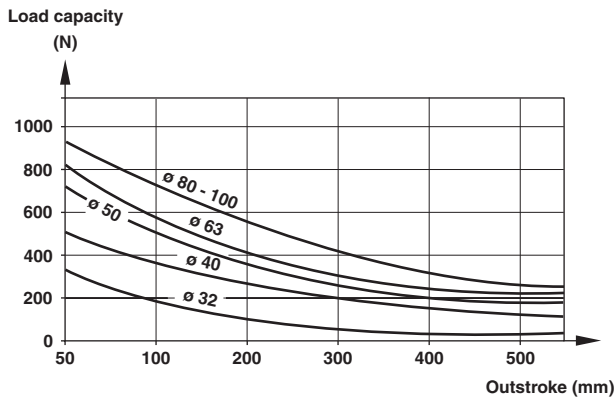

Deflection caused by own weight (diagram 2)

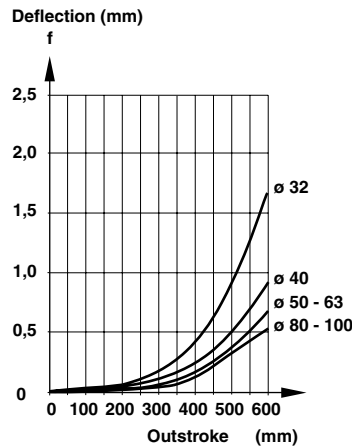

Deflection caused by a load of 10 N (diagram 3)

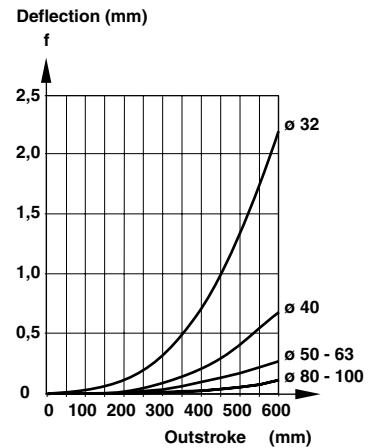

In the case of shock load applications, the figures given in the diagrams above must be reduced by a factor of 2.



QA/8000/51/* – Guide Blocks with Plain Bearings

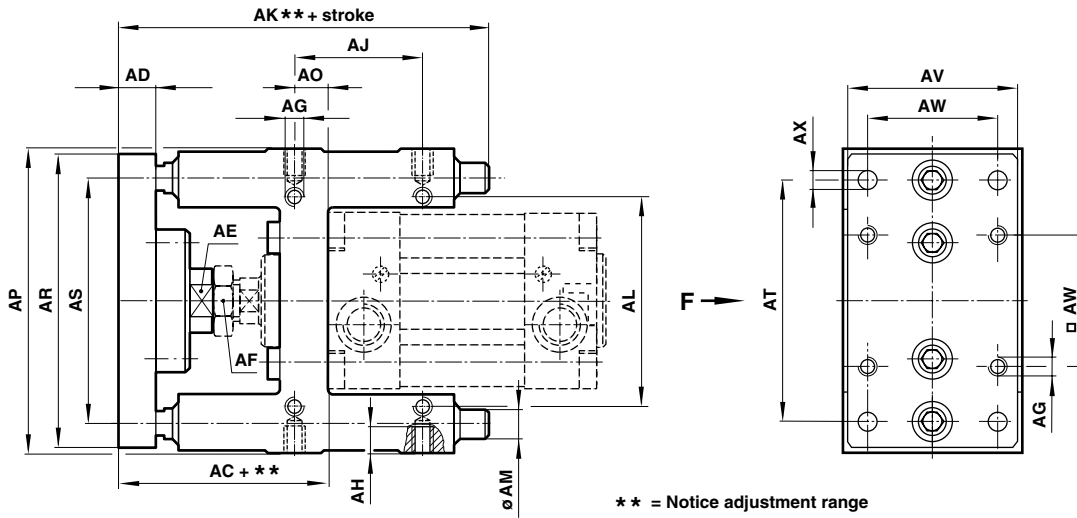

** = Notice adjustment range

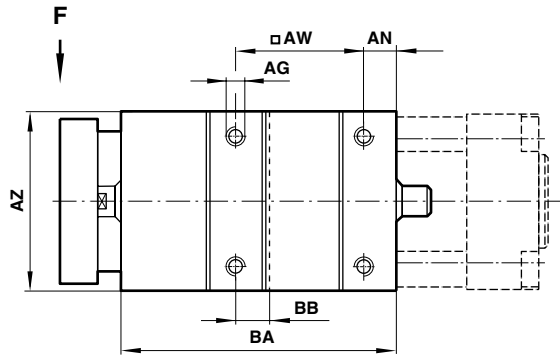

Attention:

To use the guide blocks (QA/8000/51/*) you have to order a cylinder with a barrel which is turned at 90° so that the port threads are in line with the two switch grooves.

Ordering Example:

To order a 40 mm bore magnetic piston cylinder with a 100 mm stroke and the barrel turned at 90° quote: PRA/182040/MIL/100

Non-magnetic version:
PRA/182040/IIL/100

Cylinder Ø	AC + **	AD	AE (A/F)	AF (A/F)	AG	AH	AJ	AK**	AL	ø AM	AN	AO
32	69 + 2	12	15	17	M 6	10	32,5	110	58	10	6	9
40	74 + 2	12	15	19	M 6	10	38	122	64	12	6	11
50	91,5 + 4	15	22	24	M 8	12	46,5	135	80	12	6	19
63	92 + 4	15	22	24	M 8	12	56,5	153	95	12	7	15
80	106 + 6	15	27	30	M 10	15	50	180	130	16	9	14
100	111 + 6	15	27	30	M 10	17	70	199	150	16	9	19
Cylinder Ø	AP	AR	AS	AT	AV	□ AW	ø AX	AZ	BA	BB	at 0 mm	per 100 mm
32	100	90	74	78	45	32,5	6,6	48	76	9	1,00 kg	0,06 kg
40	106	100	80	84	50	38	6,6	56	85	11	1,20 kg	0,09 kg
50	125	120	96	100	60	46,5	9	66	99	19	1,80 kg	0,09 kg
63	132	125	104	105	70	56,5	9	76	114	15	2,20 kg	0,09 kg
80	165	155	130	130	90	72	11	98	134,5	25	4,10 kg	0,16 kg
100	185	175	150	150	110	89	11	118	153,5	28,5	5,80 kg	0,16 kg

** Notice adjustment range

Note: Supplied complete with mounting screws for cylinder

Maximum load for QM/8000/51/*

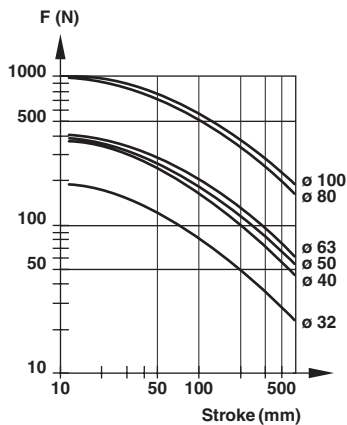



Spares

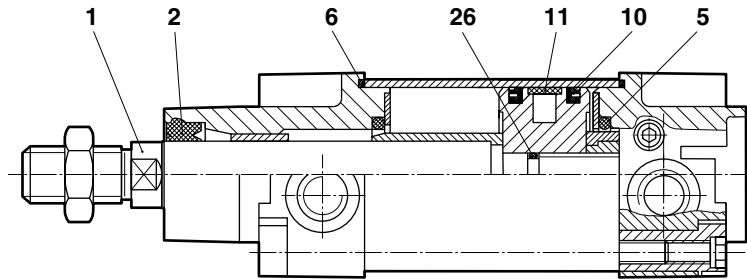

Cylinder Ø	Model	Spares kit Item	Comprising Description	Quantity	Item 1	Piston rod
32	PRA/182032	QA/8032/00	2	Piston rod seal	1	RM/P19966/*
32	PRA/182032/M	QA/8032/00	5	Cushion seal	2	SM/P19966/*
40	PRA/182040, PRA/182040/M	QA/8040/00	6	Sealing ring	2	RM/P19967/*
50	PRA/182050, PRA/182050/M	QA/8050/00	10	Piston seal	2	RM/P19968/*
63	PRA/182063, PRA/182063/M	QA/8063/00	11	Wear ring	1	RM/P19969/*
80	PRA/182080, PRA/182080/M	QA/8080/00	26	'O'-ring (∅ 32 to 100 mm)	1	RM/P19970/*
100	PRA/182100, PRA/182100/M	QA/8100/00				RM/P19971/*
125	PRA/182125, PRA/182125/M	QA/8125/00				RM/P30988/*

* Insert stroke length

Note: Please quote the cylinder type number when ordering spares kits and piston rods.

Warning

These products are intended for use in industrial compressed air systems only. Do not use these products where pressures and temperatures can exceed those listed under 'Technical Data'.

Before using these products with fluids other than those specified, for non-industrial applications, life-support systems, or other applications not within published specifications, consult NORGREN.

Through misuse, age, or malfunction, components used in fluid power systems can fail in various modes.

The system designer is warned to consider the failure modes of all component parts used in fluid power systems and to provide adequate safeguards to prevent personal injury or damage to equipment in the event of such failure.

System designers must provide a warning to end users in the system instructional manual if protection against a failure mode cannot be adequately provided.

System designers and end users are cautioned to review specific warnings found in instruction sheets packed and shipped with these products.