

### FEATURES

**Supply current: 1  $\mu$ A maximum**  
**Offset voltage: 1 mV maximum**  
**Single-supply or dual-supply operation**  
**Rail-to-rail input and output**  
**No phase reversal**  
**Unity gain stable**

### APPLICATIONS

**Portable equipment**  
**Remote sensors**  
**Low power filters**  
**Threshold detectors**  
**Current sensing**

### GENERAL DESCRIPTION

The AD8500 is a low power, precision CMOS op amp featuring a maximum supply current of 1  $\mu$ A. The AD8500 has a maximum offset voltage of 1 mV and a typical input bias current of 1 pA; it operates rail-to-rail on both the input and output. The AD8500 can operate from a single-supply voltage of +1.8 V to +5.5 V or a dual-supply voltage of  $\pm 0.9$  V to  $\pm 2.75$  V.

With its low power consumption, low input bias current, and rail-to-rail input and output, the AD8500 is ideally suited for a variety of battery-powered portable applications. Potential applications include ECGs, pulse monitors, glucose meters, smoke and fire detectors, vibration monitors, and backup battery sensors.

### PIN CONFIGURATION

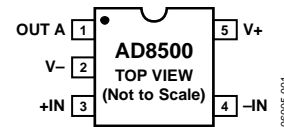

Figure 1. 5-Lead SC70

The ability to swing rail-to-rail at both the input and output helps maximize dynamic range and signal-to-noise ratio in systems that operate at very low voltages. The low offset voltage allows the AD8500 to be used in systems with high gain without having excessively large output offset errors, and it provides high accuracy without the need for system calibration.

The AD8500 is fully specified over the industrial temperature range ( $-40^{\circ}\text{C}$  to  $+85^{\circ}\text{C}$ ) and is operational over the extended industrial temperature range ( $-40^{\circ}\text{C}$  to  $+125^{\circ}\text{C}$ ). It is available in a 5-lead, SC70 surface-mount package.

Table 1. Low Supply Current Op Amps

Supply Current	1 $\mu$ A	10 $\mu$ A	20 $\mu$ A
Single	AD8500		
Dual	AD8502	ADA4505-2	AD8506
Quad	AD8504	ADA4505-4	AD8508

#### Rev. B

Information furnished by Analog Devices is believed to be accurate and reliable. However, no responsibility is assumed by Analog Devices for its use, nor for any infringements of patents or other rights of third parties that may result from its use. Specifications subject to change without notice. No license is granted by implication or otherwise under any patent or patent rights of Analog Devices. Trademarks and registered trademarks are the property of their respective owners.

**TABLE OF CONTENTS**

Features .....	1	Absolute Maximum Ratings .....	5
Applications.....	1	Thermal Resistance .....	5
General Description .....	1	ESD Caution.....	5
Pin Configuration.....	1	Typical Performance Characteristics .....	6
Revision History .....	2	Outline Dimensions .....	12
Specifications.....	3	Ordering Guide .....	12
Electrical Characteristics .....	3		

**REVISION HISTORY**

**2/09—Rev. A to Rev. B**

Added Table 1; Renumbered Sequentially .....	1
Changes to Typical Performance Characteristics Section.....	6

**8/06—Rev. 0 to Rev. A**

Updated Format.....	Universal
Changes to Figure 17, Figure 18, and Figure 19 .....	8

**4/06—Revision 0: Initial Version**

## SPECIFICATIONS

### ELECTRICAL CHARACTERISTICS

@  $V_S = 5\text{ V}$ ,  $V_{CM} = V_S/2$ ,  $T_A = 25^\circ\text{C}$ , unless otherwise noted.

Table 2.

Parameter	Symbol	Conditions	Min	Typ	Max	Unit
<b>INPUT CHARACTERISTICS</b>						
Offset Voltage	$V_{OS}$	$0\text{ V} < V_{CM} < 5\text{ V}$		0.235	1	mV
Offset Voltage Drift	$\Delta V_{OS}/\Delta T$	$-40^\circ\text{C} < T_A < +85^\circ\text{C}$		3	10	$\mu\text{V}/^\circ\text{C}$
Input Voltage Range			-0.3		+5.3	V
Input Bias Current	$I_B$	$-40^\circ\text{C} < T_A < +85^\circ\text{C}$		1	10	pA
		$-40^\circ\text{C} < T_A < +125^\circ\text{C}$			100	pA
		$-40^\circ\text{C} < T_A < +125^\circ\text{C}$			600	pA
Input Offset Current	$I_{OS}$	$-40^\circ\text{C} < T_A < +85^\circ\text{C}$		0.5	5	pA
		$-40^\circ\text{C} < T_A < +125^\circ\text{C}$			50	pA
		$-40^\circ\text{C} < T_A < +125^\circ\text{C}$			100	pA
Common-Mode Rejection Ratio	CMRR	$0\text{ V} < V_{CM} < 5\text{ V}$	75	90		dB
		$-40^\circ\text{C} < T_A < +85^\circ\text{C}$	70	90		dB
Large Signal Voltage Gain	$A_{VO}$	$0.1\text{ V} < V_{OUT} < 4.9\text{ V}$	98	120		dB
		$0.1\text{ V} < V_{OUT} < 4.9\text{ V}; -40^\circ\text{C} < T_A < +85^\circ\text{C}$	80			dB
Input Capacitance	$C_{DIFF}$ $C_{CM}$			2 4.5		pF pF
<b>OUTPUT CHARACTERISTICS</b>						
Output Voltage High	$V_{OH}$	$R_{LOAD} = 100\text{ k}\Omega$ to GND	4.970	4.995		V
		$R_{LOAD} = 10\text{ k}\Omega$ to GND	4.900	4.960		V
Output Voltage Low	$V_{OL}$	$R_{LOAD} = 100\text{ k}\Omega$ to $V_S$		0.85	5	mV
		$R_{LOAD} = 10\text{ k}\Omega$ to $V_S$		6.5	15	mV
Short-Circuit Current	$I_{SC}$	$V_{OUT} = \text{GND}$		$\pm 5$		mA
<b>POWER SUPPLY</b>						
Power Supply Rejection Ratio	PSRR	$1.8\text{ V} < V_S < 5\text{ V}$	90	110		dB
		$-40^\circ\text{C} < T_A < +85^\circ\text{C}$	80			dB
Supply Current/Amplifier	$I_{SY}$	$V_O = V_S/2$		0.75	1	$\mu\text{A}$
		$-40^\circ\text{C} < T_A < +85^\circ\text{C}$			1.5	$\mu\text{A}$
		$-40^\circ\text{C} < T_A < +125^\circ\text{C}$			2	$\mu\text{A}$
<b>DYNAMIC PERFORMANCE</b>						
Slew Rate	SR			0.004		V/ $\mu\text{s}$
Gain Bandwidth Product	GBP			7		kHz
Phase Margin	$\angle O$			60		Degrees
<b>NOISE PERFORMANCE</b>						
Peak-to-Peak Noise		0.1 Hz to 10 Hz		6		$\mu\text{V p-p}$
Voltage Noise Density	$e_n$	$f = 1\text{ kHz}$		190		$\text{nV}/\sqrt{\text{Hz}}$
Current Noise Density	$i_n$	$f = 1\text{ kHz}$		0.1		$\text{pA}/\sqrt{\text{Hz}}$

# AD8500

@  $V_S = 1.8\text{ V}$ ,  $V_{CM} = V_S/2$ ,  $T_A = 25^\circ\text{C}$ , unless otherwise noted.

Table 3.

Parameter	Symbol	Conditions	Min	Typ	Max	Unit
<b>INPUT CHARACTERISTICS</b>						
Offset Voltage	$V_{OS}$	$0\text{ V} < V_{CM} < 1.8\text{ V}$		0.235	1	mV
Offset Voltage Drift	$\Delta V_{OS}/\Delta T$	$-40^\circ\text{C} < T_A < +85^\circ\text{C}$		3.5	12	$\mu\text{V}/^\circ\text{C}$
Input Voltage Range			-0.3		+2.1	V
Input Bias Current	$I_B$	$-40^\circ\text{C} < T_A < +85^\circ\text{C}$		1	10	pA
		$-40^\circ\text{C} < T_A < +125^\circ\text{C}$			100	pA
		$-40^\circ\text{C} < T_A < +125^\circ\text{C}$			600	pA
Input Offset Current	$I_{OS}$	$-40^\circ\text{C} < T_A < +85^\circ\text{C}$		0.5	5	pA
		$-40^\circ\text{C} < T_A < +125^\circ\text{C}$			50	pA
		$-40^\circ\text{C} < T_A < +125^\circ\text{C}$			100	pA
Common-Mode Rejection Ratio	CMRR	$0\text{ V} < V_{CM} < 1.8\text{ V}$	65	85		dB
		$-40^\circ\text{C} < T_A < +85^\circ\text{C}$	60	83		dB
Large Signal Voltage Gain	$A_{VO}$	$0.1\text{ V} < V_{OUT} < 1.7\text{ V}$	88	115		dB
		$0.1\text{ V} < V_{OUT} < 1.7\text{ V}; -40^\circ\text{C} < T_A < +85^\circ\text{C}$	70			dB
Input Capacitance	$C_{DIFF}$ $C_{CM}$			2 4.5		pF pF
<b>OUTPUT CHARACTERISTICS</b>						
Output Voltage High	$V_{OH}$	$R_{LOAD} = 100\text{ k}\Omega$ to GND	1.790	1.798		V
		$R_{LOAD} = 10\text{ k}\Omega$ to GND	1.760	1.783		V
Output Voltage Low	$V_{OL}$	$R_{LOAD} = 100\text{ k}\Omega$ to $V_S$		0.70	5	mV
		$R_{LOAD} = 10\text{ k}\Omega$ to $V_S$		5	15	mV
Short-Circuit Current	$I_{SC}$			$\pm 2$		mA
<b>POWER SUPPLY</b>						
Power Supply Rejection Ratio	PSRR	$1.8\text{ V} < V_S < 5\text{ V}$	90	110		dB
		$-40^\circ\text{C} < T_A < +85^\circ\text{C}$	80			dB
Supply Current/Amplifier	$I_{SY}$	$V_O = V_S/2$		0.65	1	$\mu\text{A}$
		$-40^\circ\text{C} < T_A < +85^\circ\text{C}$			1.5	$\mu\text{A}$
		$-40^\circ\text{C} < T_A < +125^\circ\text{C}$			2	$\mu\text{A}$
<b>DYNAMIC PERFORMANCE</b>						
Slew Rate	SR			0.004		V/ $\mu\text{s}$
Gain Bandwidth Product	GBP			7		kHz
Phase Margin	$\phi_O$			60		Degrees
<b>NOISE PERFORMANCE</b>						
Peak-to-Peak Noise		0.1 Hz to 10 Hz		6		$\mu\text{V p-p}$
Voltage Noise Density	$e_n$	$f = 1\text{ kHz}$		190		$\text{nV}/\sqrt{\text{Hz}}$
Current Noise Density	$i_n$	$f = 1\text{ kHz}$		0.1		$\text{pA}/\sqrt{\text{Hz}}$

## ABSOLUTE MAXIMUM RATINGS

$T_A = 25^\circ\text{C}$ , unless otherwise noted.

Table 4.

Parameter	Rating
Supply Voltage	6 V
Input Voltage	$V_{SS} - 0.4\text{ V}$ to $V_{DD} + 0.4\text{ V}$
Differential Input Voltage	$\pm 6\text{ V}$
Output Short-Circuit Duration to GND	Indefinite
Storage Temperature Range	$-65^\circ\text{C}$ to $+150^\circ\text{C}$
Operating Temperature Range	$-40^\circ\text{C}$ to $+125^\circ\text{C}$
Junction Temperature Range	$-65^\circ\text{C}$ to $+150^\circ\text{C}$
Lead Temperature (Soldering, 60 sec)	$300^\circ\text{C}$

Stresses above those listed under Absolute Maximum Ratings may cause permanent damage to the device. This is a stress rating only; functional operation of the device at these or any other conditions above those indicated in the operational section of this specification is not implied. Exposure to absolute maximum rating conditions for extended periods may affect device reliability.

Absolute maximum ratings apply at  $25^\circ\text{C}$ , unless otherwise noted.

### THERMAL RESISTANCE

$\theta_{JA}$  is specified for the worst-case conditions, that is, a device soldered in a circuit board for surface-mount packages.

Table 5. Thermal Characteristics

Package Type	$\theta_{JA}$	$\theta_{JC}$	Unit
5-Lead SC70 (KS-5)	376	126	$^\circ\text{C}/\text{W}$

### ESD CAUTION

ESD (electrostatic discharge) sensitive device. Electrostatic charges as high as 4000 V readily accumulate on the human body and test equipment and can discharge without detection. Although this product features proprietary ESD protection circuitry, permanent damage may occur on devices subjected to high energy electrostatic discharges. Therefore, proper ESD precautions are recommended to avoid performance degradation or loss of functionality.



## TYPICAL PERFORMANCE CHARACTERISTICS

$T_A = 25^\circ\text{C}$ , unless otherwise noted.

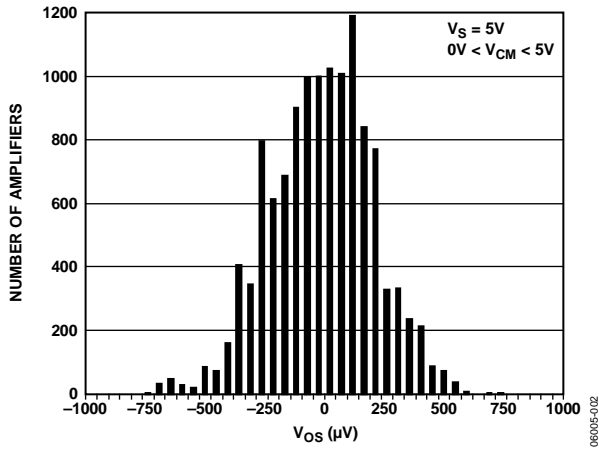

Figure 2. Input Offset Voltage Distribution

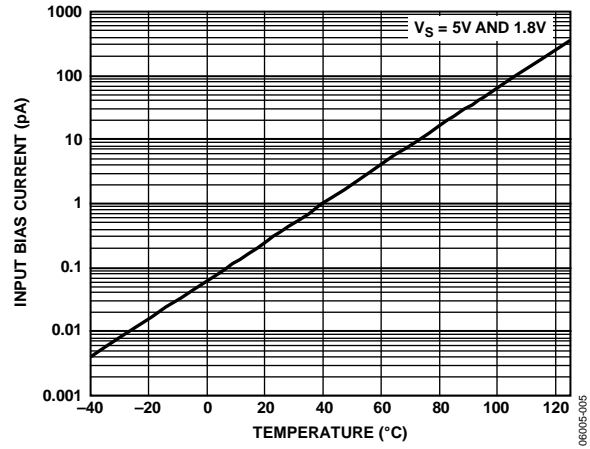

Figure 5. Input Bias Current vs. Temperature

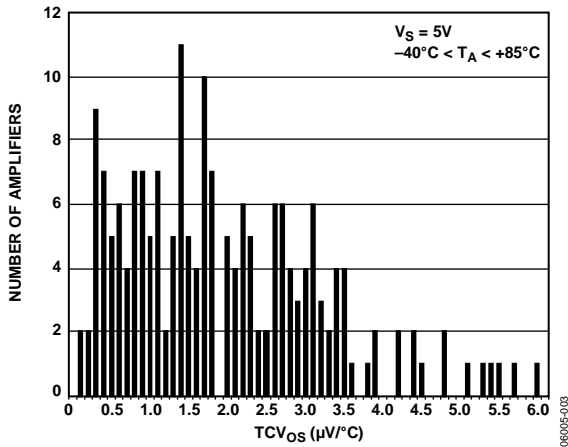

Figure 3. Input Offset Voltage Drift Distribution

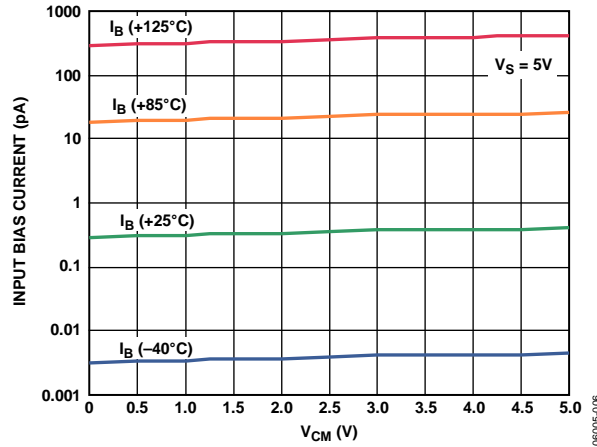

Figure 6. Input Bias Current vs. Common-Mode Voltage

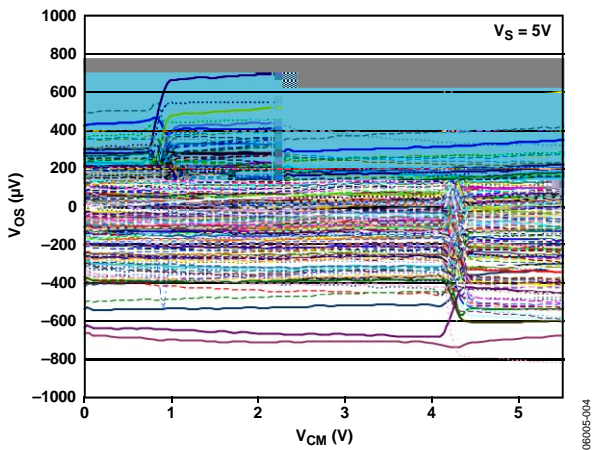

Figure 4. Input Offset Voltage vs. Common-Mode Voltage

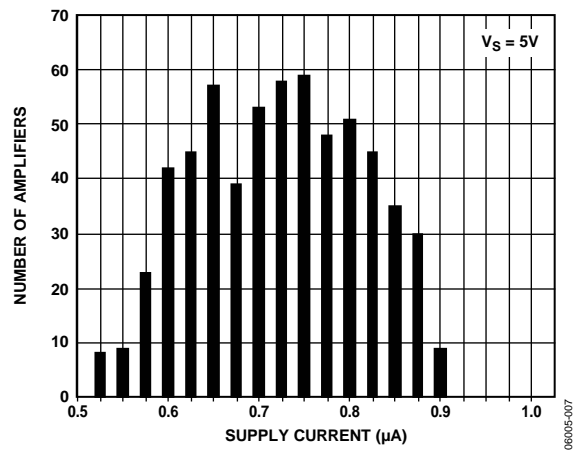

Figure 7. Supply Current Distribution

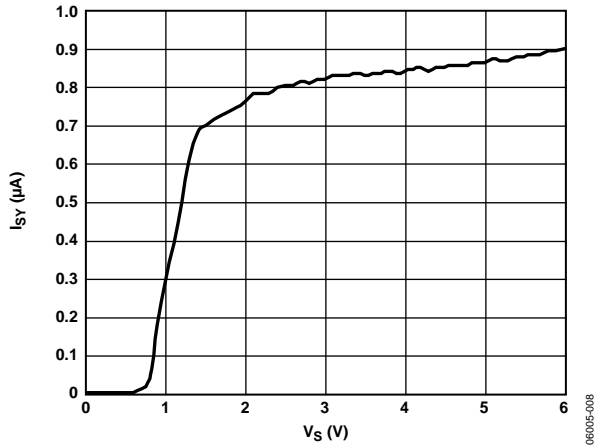

Figure 8. Supply Current vs. Supply Voltage

06005-008

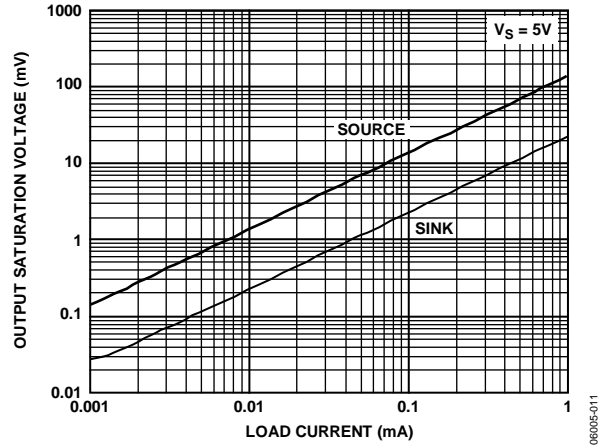

Figure 11. Output Saturation Voltage vs. Load Current

06005-011

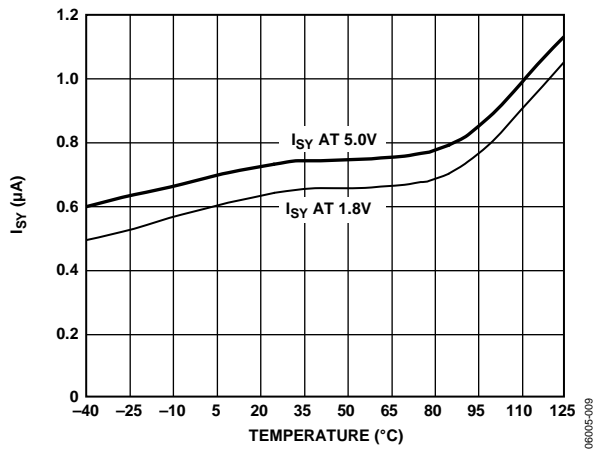

Figure 9. Supply Current vs. Temperature

06005-009

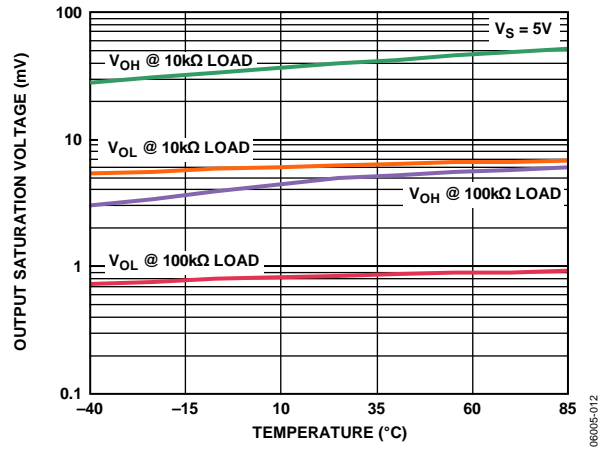

Figure 12. Output Saturation Voltage vs. Temperature

06005-012

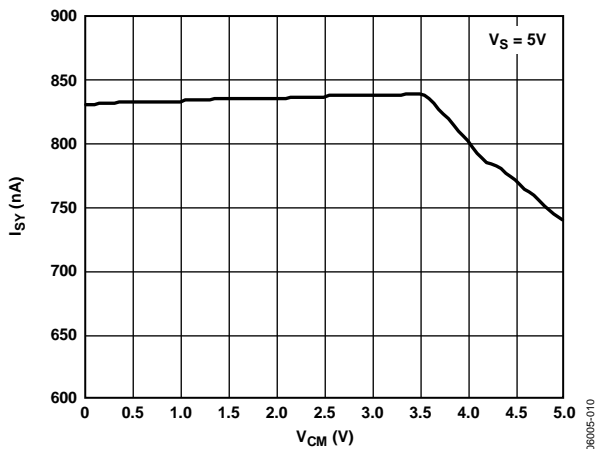

Figure 10. Supply Current vs. Input Common-Mode Voltage

06005-010

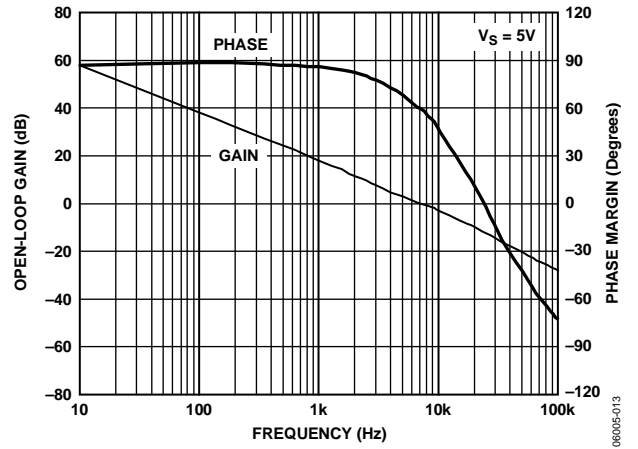

Figure 13. Open-Loop Gain and Phase vs. Frequency

06005-013

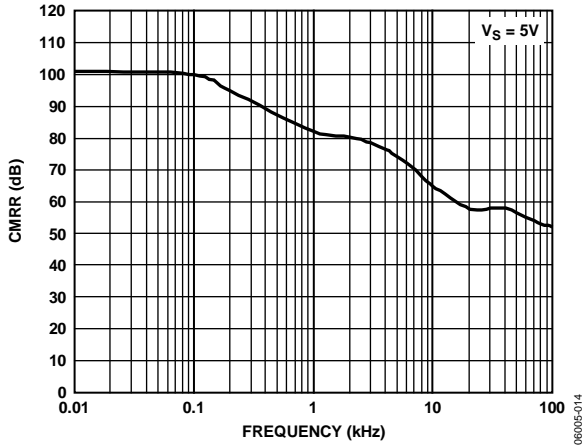

Figure 14. CMRR vs. Frequency

06005-014

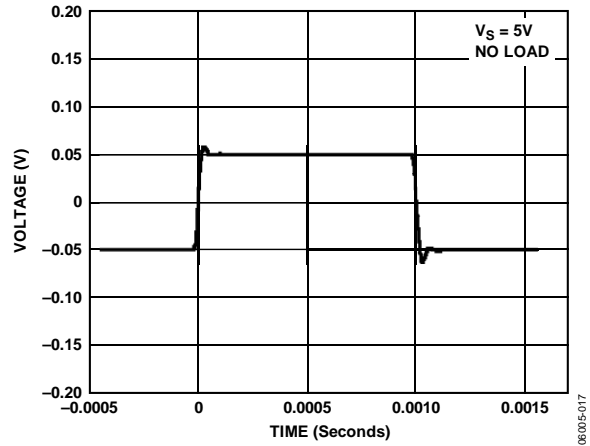

Figure 17. Small Signal Transient Response

06005-017

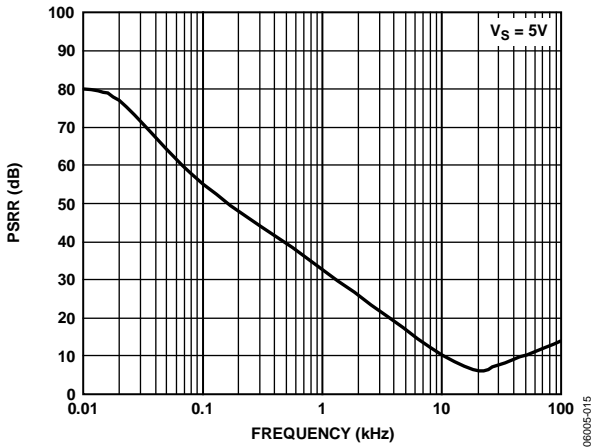

Figure 15. PSRR vs. Frequency

06005-015

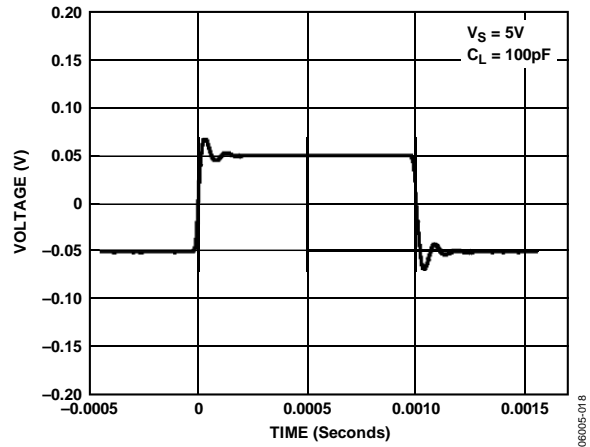

Figure 18. Small Signal Transient Response

06005-018

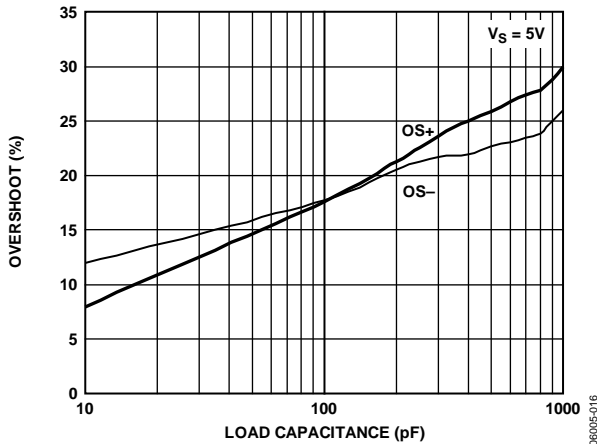

Figure 16. Small Signal Overshoot vs. Load Capacitance

06005-016

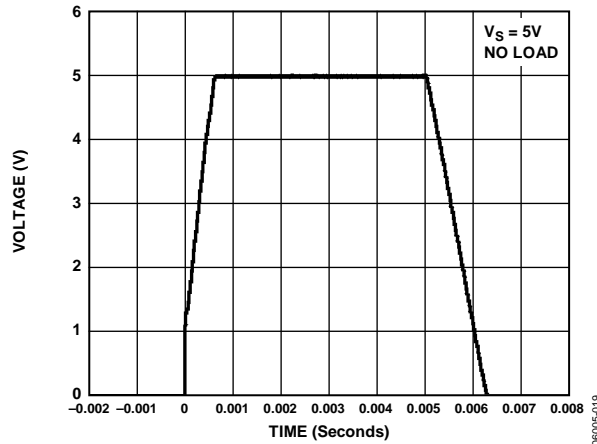

Figure 19. Large Signal Transient Response

06005-019



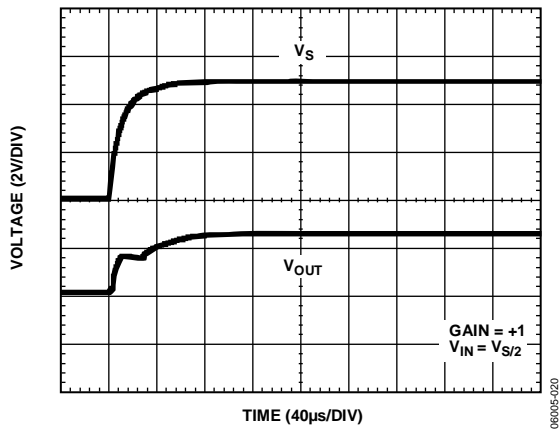

Figure 20. Turn-On Transient Response

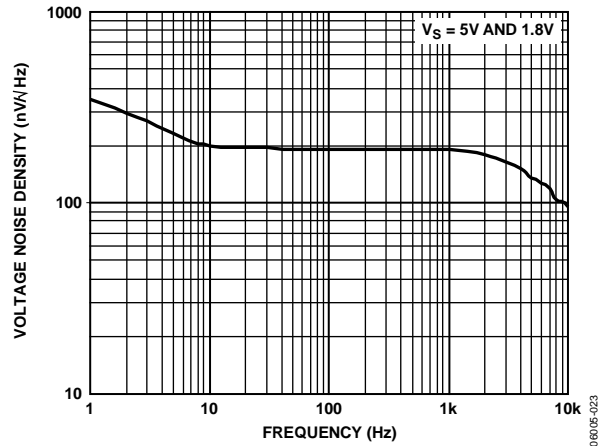

Figure 23. Voltage Noise Density

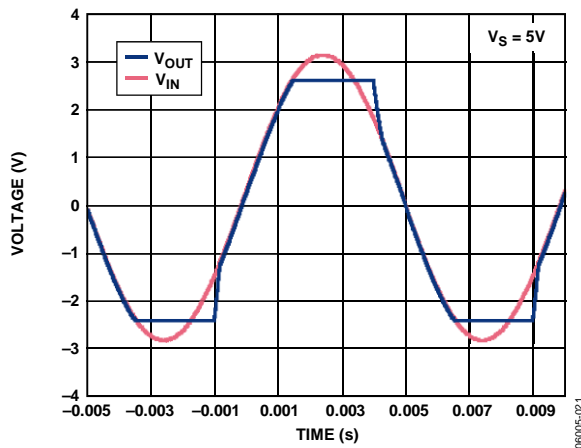

Figure 21. No Phase Reversal

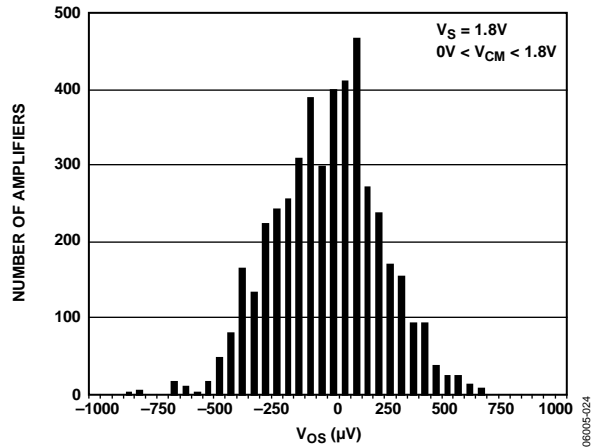

Figure 24. Input Offset Voltage Distribution

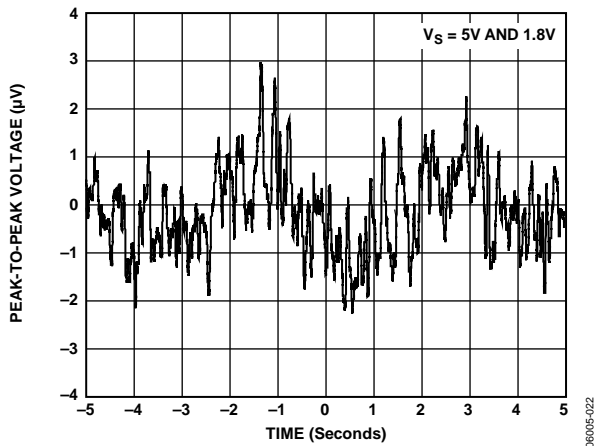

Figure 22. 0.1 Hz to 10 Hz Input Voltage Noise

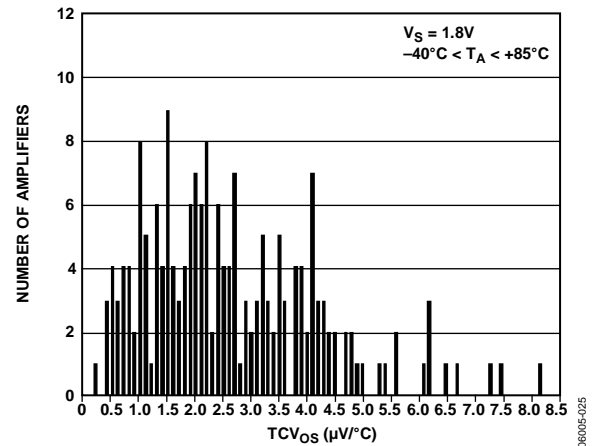

Figure 25. Input Offset Voltage Drift Distribution

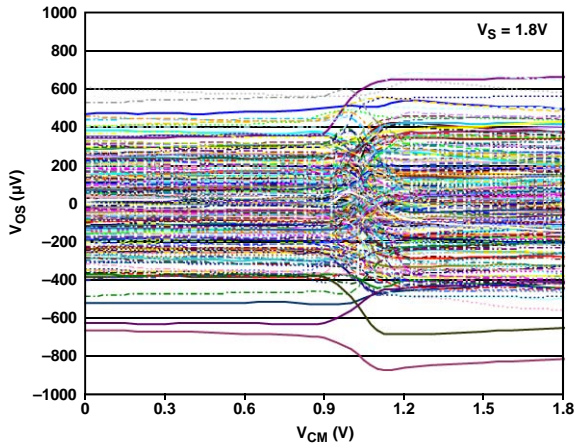

Figure 26. Input Offset Voltage vs. Input Common-Mode Voltage

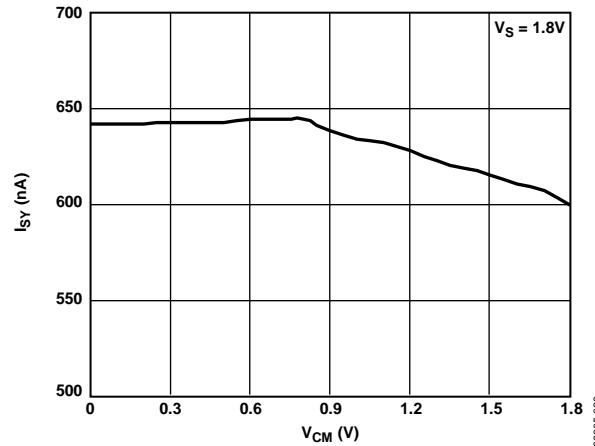

Figure 29. Supply Current vs. Input Common-Mode Voltage

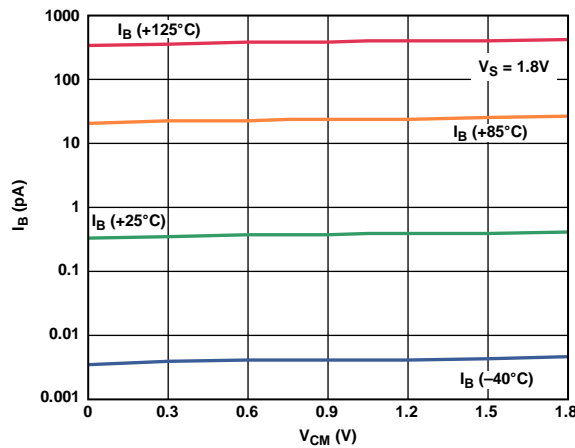

Figure 27. Input Bias Current vs. Input Common-Mode Voltage

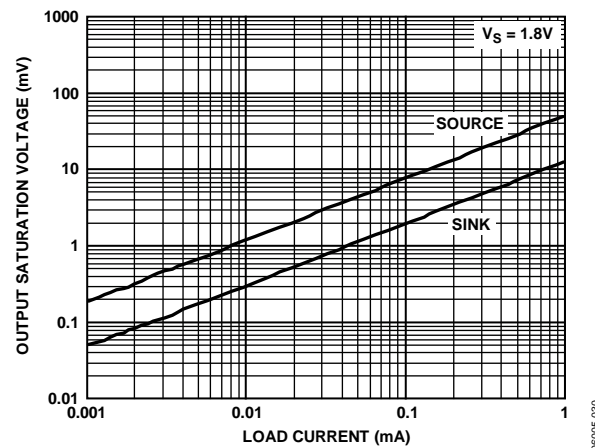

Figure 30. Output Saturation Voltage vs. Load Current

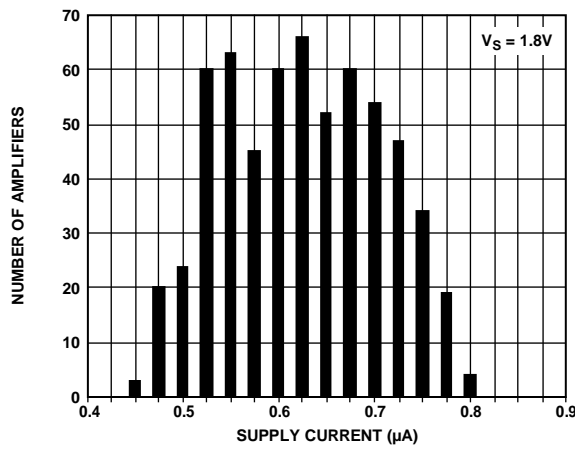

Figure 28. Supply Current Distribution

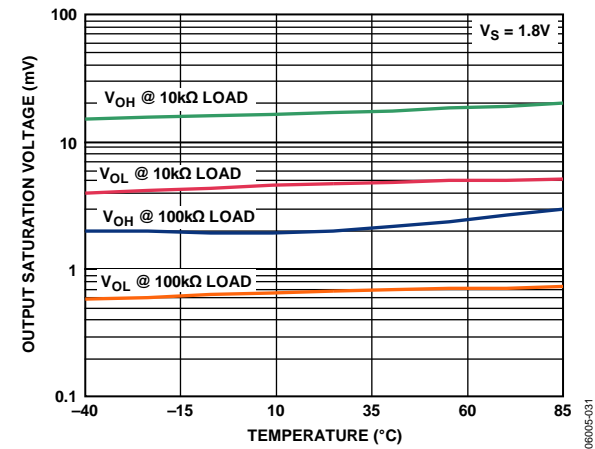

Figure 31. Output Saturation Voltage vs. Temperature

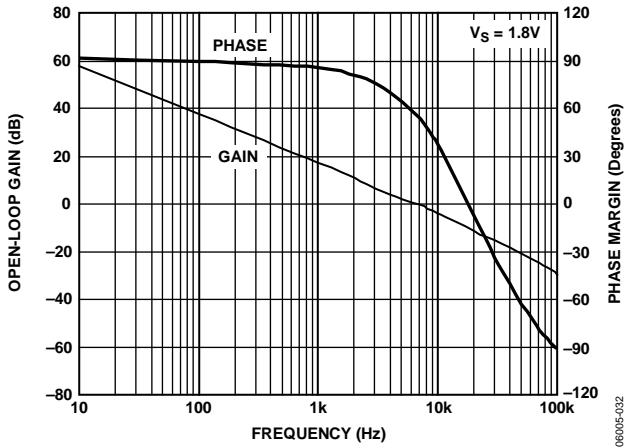

Figure 32. Open-Loop Gain and Phase vs. Frequency

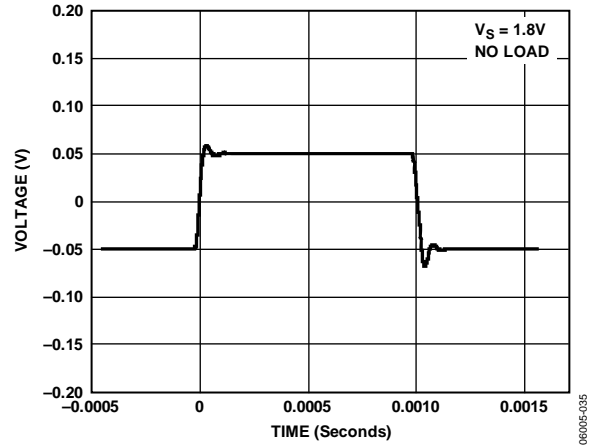

Figure 35. Small Signal Transient Response

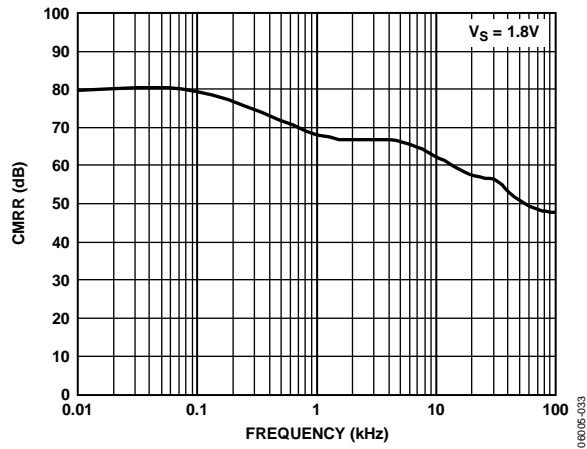

Figure 33. CMRR vs. Frequency

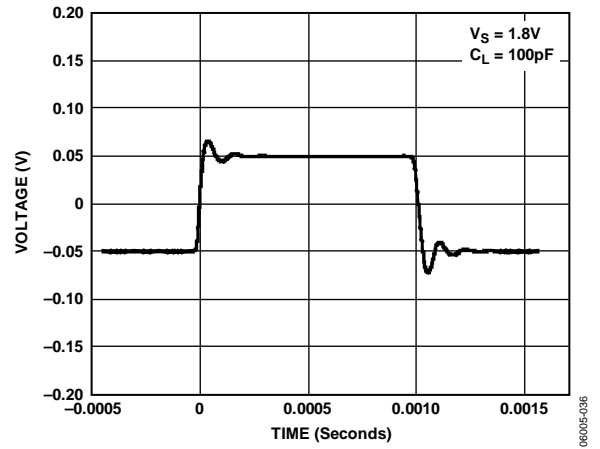

Figure 36. Small Signal Transient Response

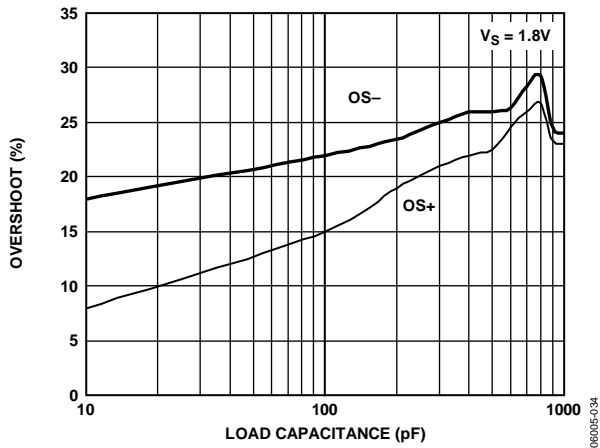

Figure 34. Small Signal Overshoot vs. Load Capacitance

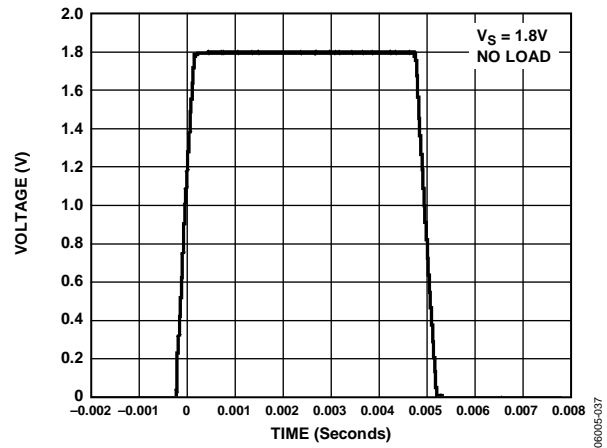
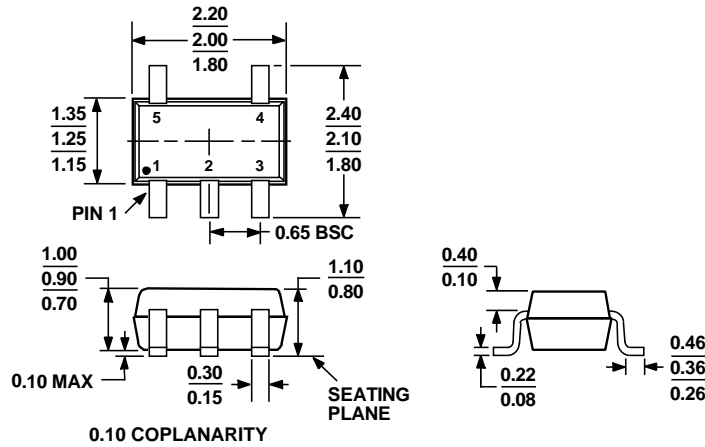

Figure 37. Large Signal Transient Response

# AD8500

## OUTLINE DIMENSIONS



COMPLIANT TO JEDEC STANDARDS MO-203-AA

Figure 38. 5-Lead Thin Shrink Small Outline Transistor Package [SC70] (KS-5)

Dimensions shown in millimeters

## ORDERING GUIDE

Model	Temperature Range	Package Description	Package Option	Branding
AD8500AKSZ-R2 <sup>1</sup>	-40°C to +125°C	5-Lead SC70	KS-5	A0F
AD8500AKSZ-REEL <sup>1</sup>	-40°C to +125°C	5-Lead SC70	KS-5	A0F
AD8500AKSZ-REEL7 <sup>1</sup>	-40°C to +125°C	5-Lead SC70	KS-5	A0F

<sup>1</sup> Z = RoHS Compliant Part.