

Description

This advanced MOSFET technology has been especially tailored to reduce on-state resistance, and to provide superior switching performance and high avalanche energy strength. These devices are suitable for switched mode power supplies, audio amplifier, DC motor control, and variable switching power applications.

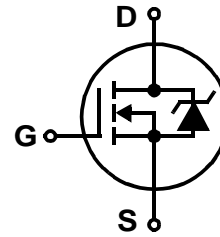

Features

$V_{DS} = 100V$

$I_D = 10A$ ($V_{GS} = 10V$)

$R_{DS(ON)} < 180m\Omega$ ($V_{GS} = 10V$), $I_D = 5.0 A$

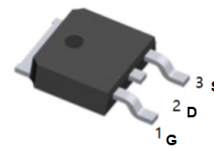

TO-252(DPAK) top view

Absolute Maximum Ratings $T_C = 25^\circ C$ unless otherwise noted.

Symbol	Parameter	FQD13N10L	Unit
V_{DSS}	Drain-Source Voltage	100	V
I_D	Drain Current - Continuous ($T_C = 25^\circ C$)	10	A
	- Continuous ($T_C = 100^\circ C$)	6.3	A
I_{DM}	Drain Current - Pulsed (Note 1)	40	A
V_{GSS}	Gate-Source Voltage	± 20	V
E_{AS}	Single Pulsed Avalanche Energy (Note 2)	95	mJ
I_{AR}	Avalanche Current (Note 1)	10	A
E_{AR}	Repetitive Avalanche Energy (Note 1)	4.0	mJ
dv/dt	Peak Diode Recovery dv/dt (Note 3)	6.0	V/ns
P_D	Power Dissipation ($T_A = 25^\circ C$)	2.5	W
	Power Dissipation ($T_C = 25^\circ C$)	40	W
	- Derate above $25^\circ C$	0.32	W/ $^\circ C$
T_J, T_{STG}	Operating and Storage Temperature Range	-55 to +150	$^\circ C$
T_L	Maximum Lead Temperature for Soldering, 1/8" from Case for 5 Seconds	300	$^\circ C$

Thermal Characteristics

Symbol	Parameter	FQD13N10L	Unit
$R_{\theta JC}$	Thermal Resistance, Junction to Case, Max.	3.13	$^\circ C/W$
$R_{\theta JA}$	Thermal Resistance, Junction to Ambient (Minimum Pad of 2-oz Copper), Max.	110	
	Thermal Resistance, Junction to Ambient (*1 in ² Pad of 2-oz Copper), Max.	50	

Electrical Characteristics T_C = 25°C unless otherwise noted.

Symbol	Parameter	Test Conditions	Min.	Typ.	Max.	Unit
BV _{DSS}	Drain-Source Breakdown Voltage	V _{GS} = 0 V, I _D = 250 μA	100	--	--	V
ΔBV _{DSS} / ΔT _J	Breakdown Voltage Temperature Coefficient	I _D = 250 μA, Referenced to 25°C	--	0.09	--	V/°C
I _{DSS}	Zero Gate Voltage Drain Current	V _{DS} = 100 V, V _{GS} = 0 V	--	--	1	μA
		V _{DS} = 80 V, T _C = 125°C	--	--	10	μA
I _{GSSF}	Gate-Body Leakage Current, Forward	V _{GS} = 20 V, V _{DS} = 0 V	--	--	100	nA
I _{GSSR}	Gate-Body Leakage Current, Reverse	V _{GS} = -20 V, V _{DS} = 0 V	--	--	-100	nA
V _{GS(th)}	Gate Threshold Voltage	V _{DS} = V _{GS} , I _D = 250 μA	1.0	--	2.0	V
R _{DS(on)}	Static Drain-Source On-Resistance	V _{GS} = 10 V, I _D = 5.0 A V _{GS} = 5 V, I _D = 5.0 A	--	142 158	180 200	mΩ
g _{FS}	Forward Transconductance	V _{DS} = 30 V, I _D = 5.0 A	--	8.7	--	S
C _{iss}	Input Capacitance	V _{DS} = 25 V, V _{GS} = 0 V, f = 1.0 MHz	--	400	520	pF
C _{oss}	Output Capacitance		--	95	125	pF
C _{rss}	Reverse Transfer Capacitance		--	20	25	pF
t _{d(on)}	Turn-On Delay Time	V _{DD} = 50 V, I _D = 12.8 A, R _G = 25 Ω (Note 4)	--	7.5	25	ns
t _r	Turn-On Rise Time		--	220	450	ns
t _{d(off)}	Turn-Off Delay Time		--	22	55	ns
t _f	Turn-Off Fall Time		--	72	150	ns
Q _g	Total Gate Charge	V _{DS} = 80 V, I _D = 12.8 A, V _{GS} = 5 V (Note 4)	--	8.7	12	nC
Q _{gs}	Gate-Source Charge		--	2.0	--	nC
Q _{gd}	Gate-Drain Charge		--	5.3	--	nC
I _S	Maximum Continuous Drain-Source Diode Forward Current		--	--	10	A
I _{SM}	Maximum Pulsed Drain-Source Diode Forward Current		--	--	40	A
V _{SD}	Drain-Source Diode Forward Voltage	V _{GS} = 0 V, I _S = 10 A	--	--	1.5	V
t _{rr}	Reverse Recovery Time	V _{GS} = 0 V, I _S = 12.8 A, dI _F / dt = 100 A/μs	--	75	--	ns
Q _{rr}	Reverse Recovery Charge		--	0.17	--	μC

Notes:

1. Repetitive rating : pulse-width limited by maximum junction temperature.
2. L = 1.43 mH, I_{AS} = 10 A, V_{DD} = 25 V, R_G = 25 Ω, Starting T_J = 25°C.
3. I_{SD} ≤ 12.8 A, di/dt ≤ 300 A/μs, V_{DD} ≤ BV_{DSS}, Starting T_J = 25°C.
4. Essentially independent of operating temperature.

Typical Characteristics

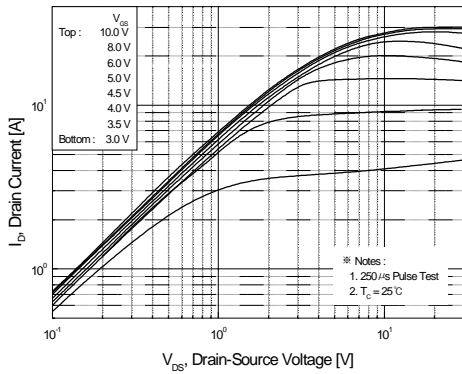

Figure 1. On-Region Characteristics

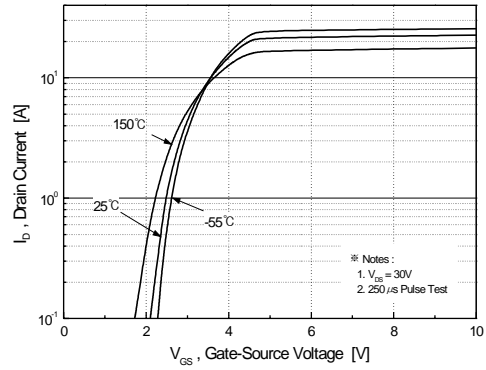

Figure 2. Transfer Characteristics

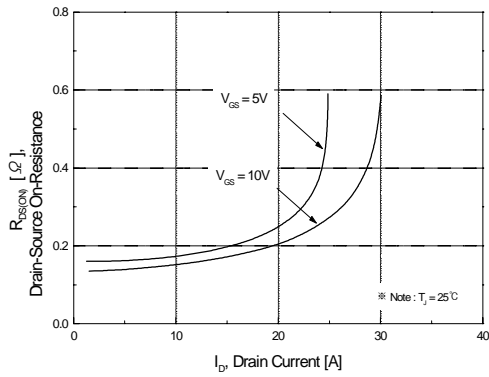

Figure 3. On-Resistance Variation vs. Drain Current and Gate Voltage

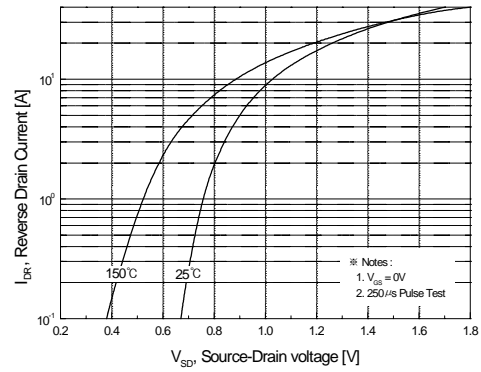

Figure 4. Body Diode Forward Voltage Variation vs. Source Current and Temperature

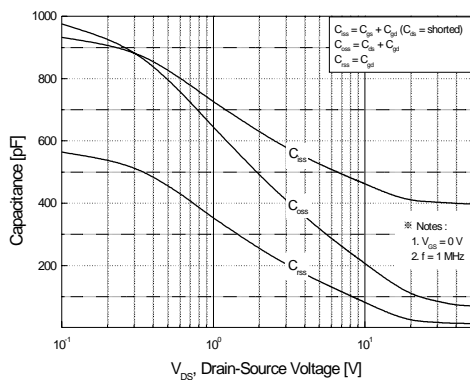

Figure 5. Capacitance Characteristics

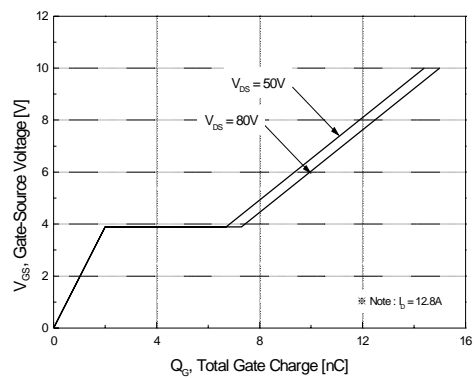

Figure 6. Gate Charge Characteristics

Typical Characteristics (Continued)

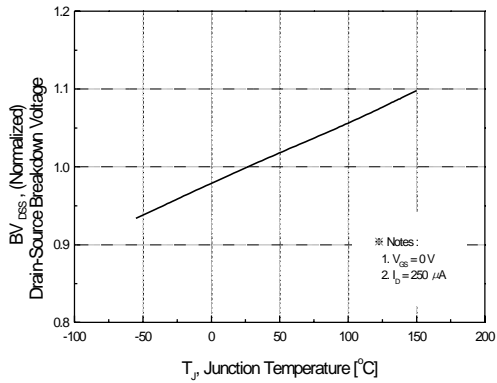

Figure 7. Breakdown Voltage Variation vs. Temperature

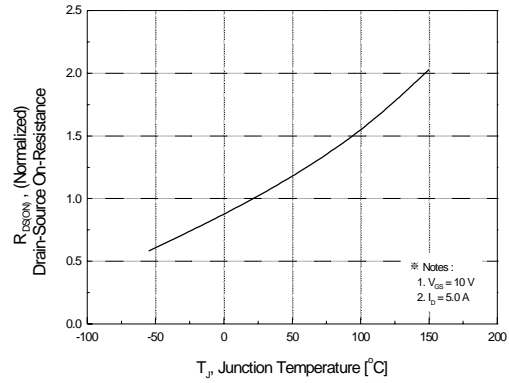

Figure 8. On-Resistance Variation vs. Temperature

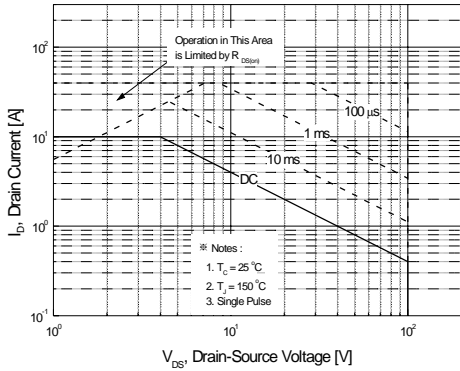

Figure 9. Maximum Safe Operating Area

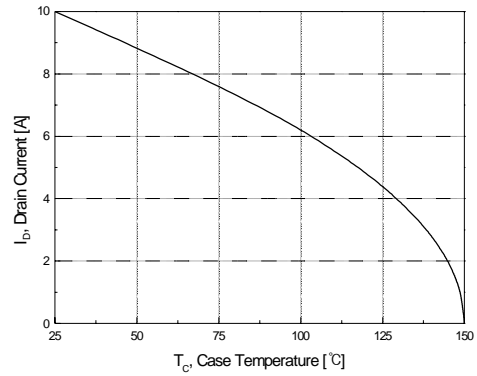

Figure 10. Maximum Drain Current vs. Case Temperature

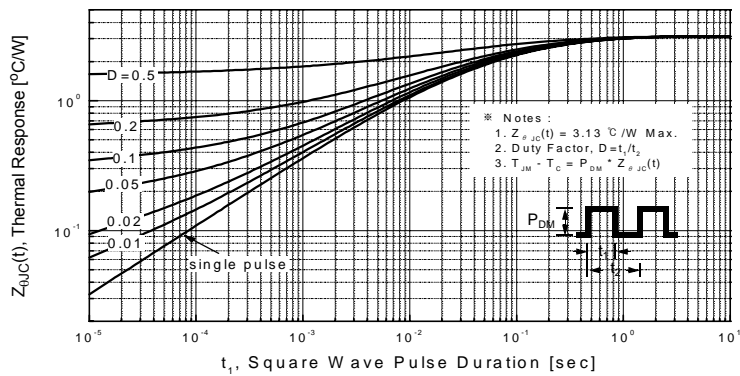

Figure 11. Transient Thermal Response Curve

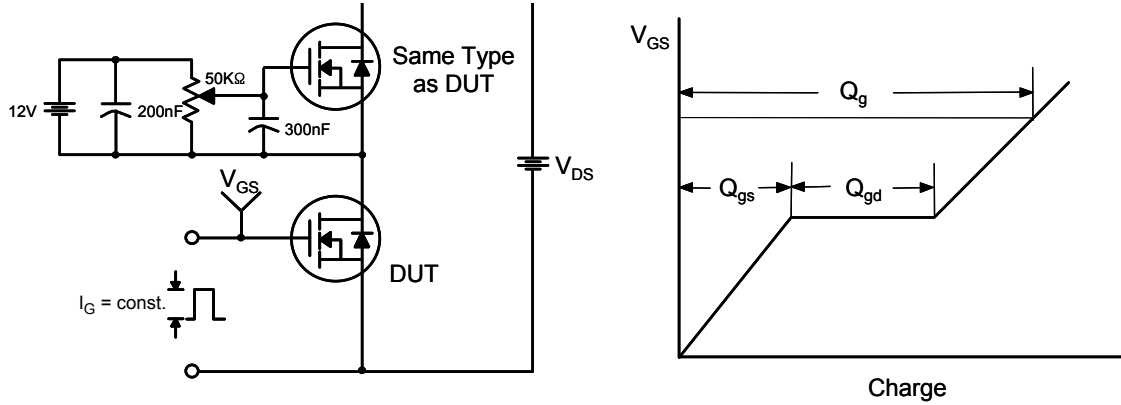

Figure 12. Gate Charge Test Circuit & Waveform

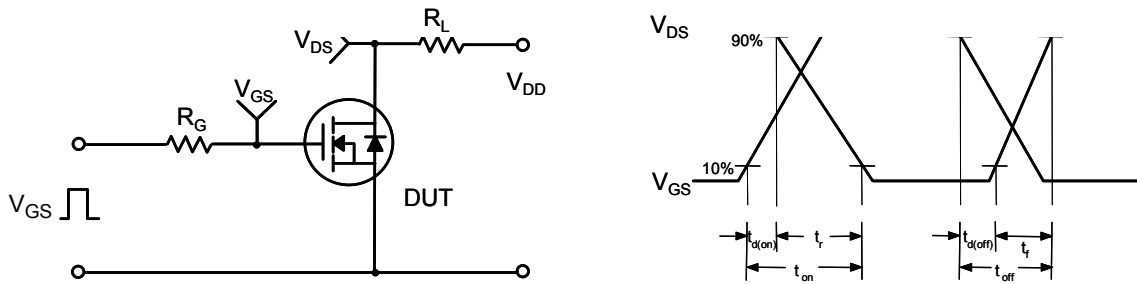

Figure 13. Resistive Switching Test Circuit & Waveforms

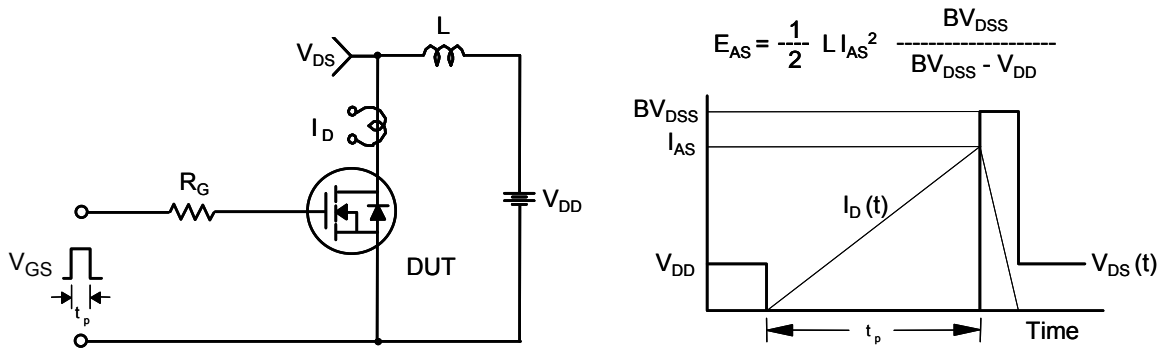

Figure 14. Unclamped Inductive Switching Test Circuit & Waveforms

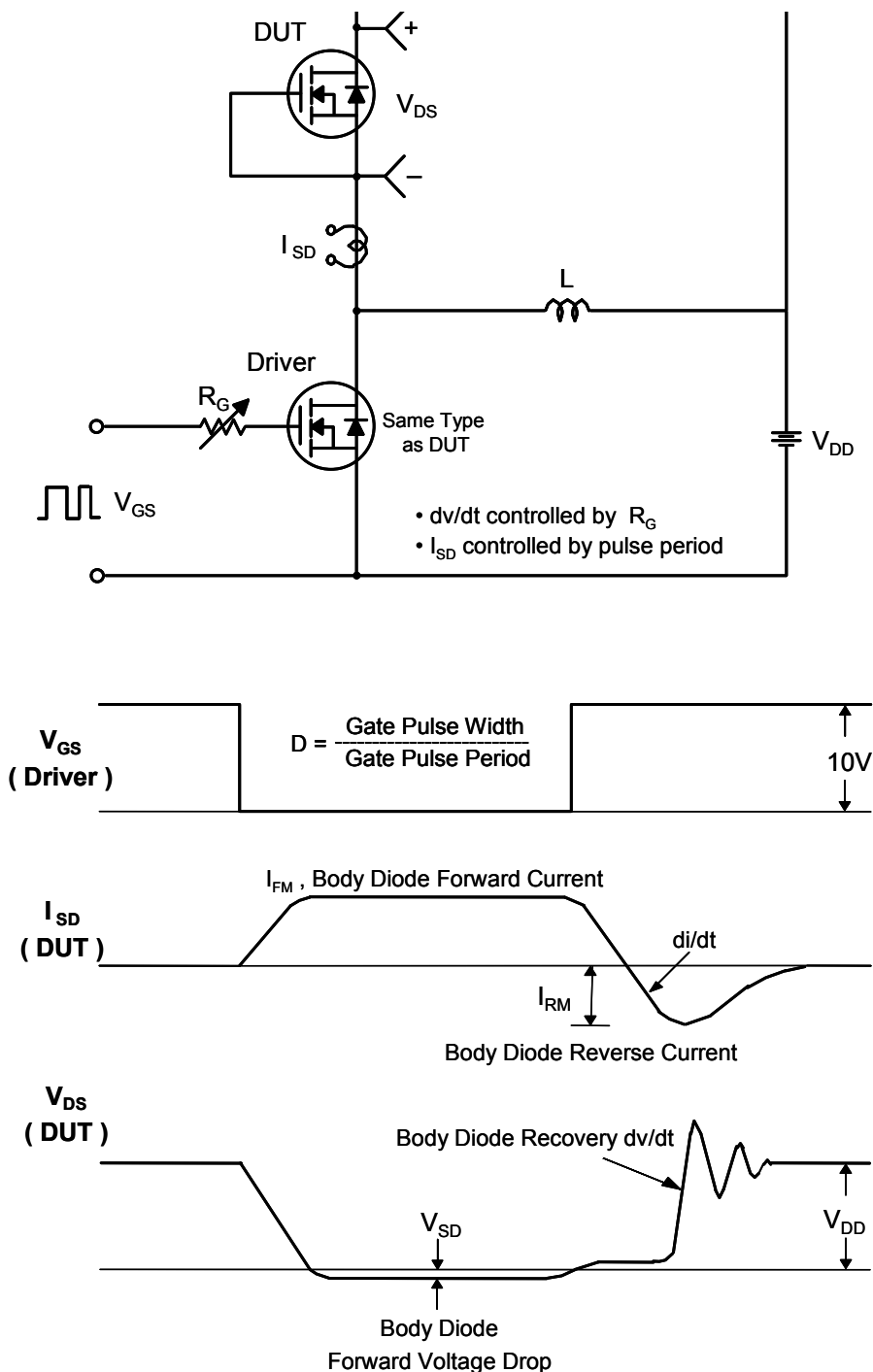
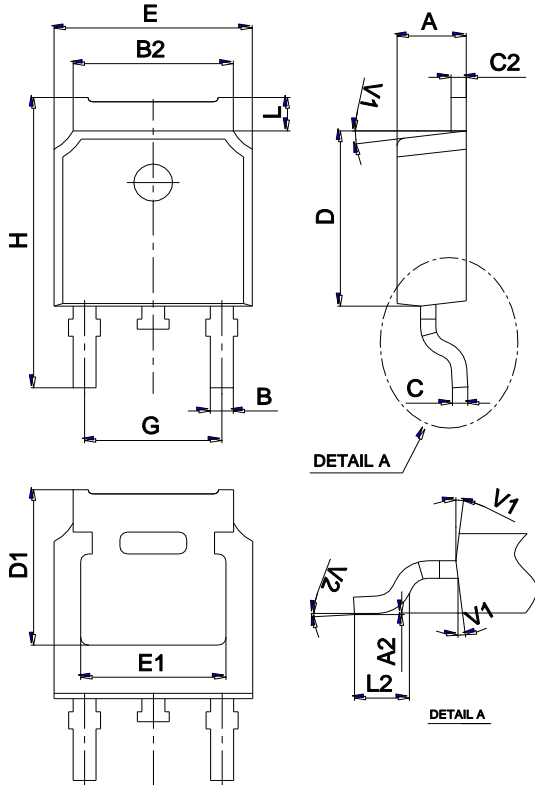

Figure 15. Peak Diode Recovery dv/dt Test Circuit & Waveforms

Package Mechanical Data TO-252



Ref.	Dimensions					
	Millimeters			Inches		
	Min.	Typ.	Max.	Min.	Typ.	Max.
A	2.10		2.50	0.083		0.098
A2	0		0.10	0		0.004
B	0.66		0.86	0.026		0.034
B2	5.18		5.48	0.202		0.216
C	0.40		0.60	0.016		0.024
C2	0.44		0.58	0.017		0.023
D	5.90		6.30	0.232		0.248
D1	5.30REF			0.209REF		
E	6.40		6.80	0.252		0.268
E1	4.63			0.182		
G	4.47		4.67	0.176		0.184
H	9.50		10.70	0.374		0.421
L	1.09		1.21	0.043		0.048
L2	1.35		1.65	0.053		0.065
V1		7°			7°	
V2	0°		6°	0°		6°

Ordering information

Order code	Package	Baseqty	Delivery mode
UMW FQD13N10LTM	TO-252	2500	Tape and reel