

**General Description**

These devices are particularly suited for low voltage applications in notebook computers, portable phones, PCMCIA cards, and other battery powered circuits where fast switching, and low in-line power loss are needed in a very small outline surface mount package. <sup>®</sup>

**Features**

- $V_{DS} (V) = 30V$
- $R_{DS(ON)} < 110m\Omega$  ( $V_{GS} = 10V$ )
- $R_{DS(ON)} < 160m\Omega$  ( $V_{GS} = 4.5V$ )

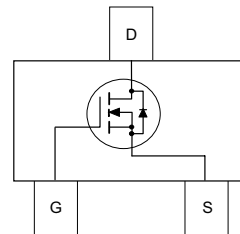
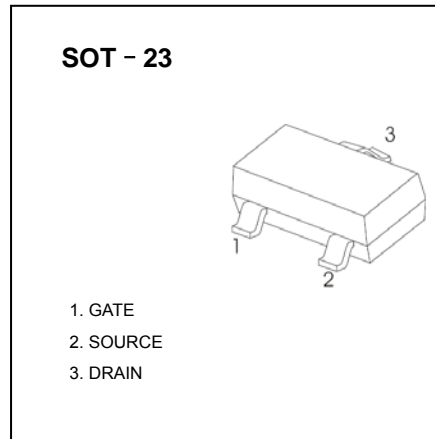

**Absolute Maximum Ratings**  $T_A=25^{\circ}C$  unless otherwise noted

Symbol	Parameter	Ratings	Units
$V_{DSS}$	Drain-Source Voltage	30	V
$V_{GSS}$	Gate-Source Voltage	$\pm 20$	V
$I_D$	Drain Current – Continuous (Note 1a)	1.4	A
	– Pulsed	10	
$P_D$	Power Dissipation for Single Operation (Note 1a) (Note 1b)	0.5	W
		0.46	
$T_J, T_{STG}$	Operating and Storage Junction Temperature Range	-55 to +150	$^{\circ}C$
<b>Thermal Characteristics</b>			
$R_{\theta JA}$	Thermal Resistance, Junction-to-Ambient (Note 1a)	250	$^{\circ}C/W$
$R_{\theta JC}$	Thermal Resistance, Junction-to-Case (Note 1)	75	

## Electrical Characteristics

$T_A = 25^\circ\text{C}$  unless otherwise noted

Symbol	Parameter	Test Conditions	Min	Typ	Max	Units
<b>Off Characteristics</b>						
$BV_{DSS}$	Drain–Source Breakdown Voltage	$V_{GS} = 0\text{ V}, I_D = 250\ \mu\text{A}$	30			V
$\frac{\Delta BV_{DSS}}{\Delta T_J}$	Breakdown Voltage Temperature Coefficient	$I_D = 250\ \mu\text{A}$ , Referenced to $25^\circ\text{C}$		26		$\text{mV}/^\circ\text{C}$
$I_{DSS}$	Zero Gate Voltage Drain Current	$V_{DS} = 24\text{ V}, V_{GS} = 0\text{ V}$			1	$\mu\text{A}$
		$V_{DS} = 24\text{ V}, V_{GS} = 0\text{ V}, T_J = 55^\circ\text{C}$			10	$\mu\text{A}$
$I_{GSS}$	Gate–Body Leakage	$V_{GS} = \pm 20\text{ V}, V_{DS} = 0\text{ V}$			$\pm 100$	nA
<b>On Characteristics (Note 2)</b>						
$V_{GS(th)}$	Gate Threshold Voltage	$V_{DS} = V_{GS}, I_D = 250\ \mu\text{A}$	1	2.1	3	V
$R_{DS(on)}$	Static Drain–Source On–Resistance	$V_{GS} = 10\text{ V}, I_D = 1.4\text{ A}$		92	110	m $\Omega$
		$V_{GS} = 4.5\text{ V}, I_D = 1.2\text{ A}$		120	160	
$I_{D(on)}$	On–State Drain Current	$V_{GS} = 4.5\text{ V}, V_{DS} = 5\text{ V}$	3.5			A
$g_{FS}$	Forward Transconductance	$V_{DS} = 5\text{ V}, I_D = 1.4\text{ A}$		4		S
<b>Dynamic Characteristics</b>						
$C_{iss}$	Input Capacitance	$V_{DS} = 15\text{ V}, V_{GS} = 0\text{ V}, f = 1.0\text{ MHz}$		145	193	pF
$C_{oss}$	Output Capacitance			35	47	
$C_{rss}$	Reverse Transfer Capacitance			15	23	
$R_G$	Gate Resistance	$V_{GS} = 15\text{ mV}, f = 1.0\text{ MHz}$		1.6		$\Omega$
<b>Switching Characteristics (Note 2)</b>						
$t_{d(on)}$	Turn–On Delay Time	$V_{DD} = 15\text{ V}, I_D = 1\text{ A}, V_{GS} = 10\text{ V}, R_{GEN} = 6\ \Omega$		3	6	ns
$t_r$	Turn–On Rise Time			8	16	
$t_{d(off)}$	Turn–Off Delay Time			16	29	
$t_f$	Turn–Off Fall Time			2	4	
$Q_g$	Total Gate Charge	$V_{DS} = 15\text{ V}, I_D = 1.4\text{ A}, V_{GS} = 4.5\text{ V}$		1.3	1.8	nC
$Q_{gs}$	Gate–Source Charge			0.5		
$Q_{gd}$	Gate–Drain Charge			0.5		
<b>Drain–Source Diode Characteristics</b>						
$V_{SD}$	Drain–Source Diode Forward Voltage	$V_{GS} = 0\text{ V}, I_S = 0.42\text{ A}$ (Note 2)		0.8	1.2	V
$t_{rr}$	Diode Reverse Recovery Time	$I_F = 1.4\text{ A}, dI_F/dt = 100\text{ A}/\mu\text{s}$		11	22	nS
$Q_{rr}$	Diode Reverse Recovery Charge			4		

**Notes:**

- $R_{\theta JA}$  is the sum of the junction-to-case and case-to-ambient thermal resistance where the case thermal reference is defined as the solder mounting surface of the drain pins.  $R_{\theta JC}$  is guaranteed by design while  $R_{\theta CA}$  is determined by the user's board design.



a)  $250^\circ\text{C}/\text{W}$  when mounted on a  $0.02\text{ in}^2$  pad of 2 oz. copper.



b)  $270^\circ\text{C}/\text{W}$  when mounted on a minimum pad.

Scale 1 : 1 on letter size paper

- Pulse Test: Pulse Width  $\leq 300\ \mu\text{s}$ , Duty Cycle  $\leq 2.0\%$

**Typical Characteristics**

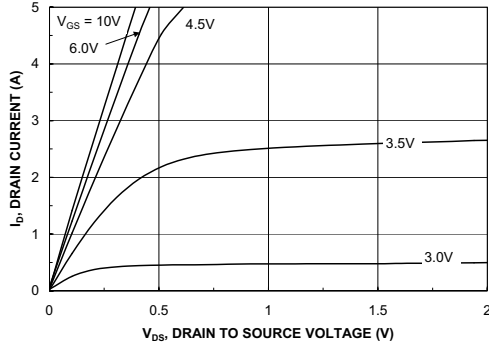

**Figure 1. On-Region Characteristics.**

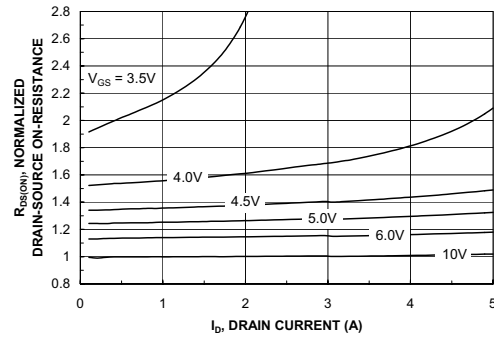

**Figure 2. On-Resistance Variation with Drain Current and Gate Voltage.**

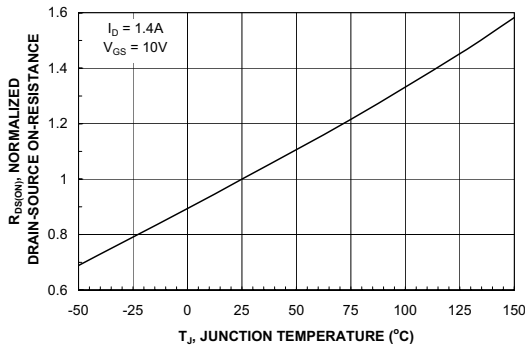

**Figure 3. On-Resistance Variation with Temperature.**

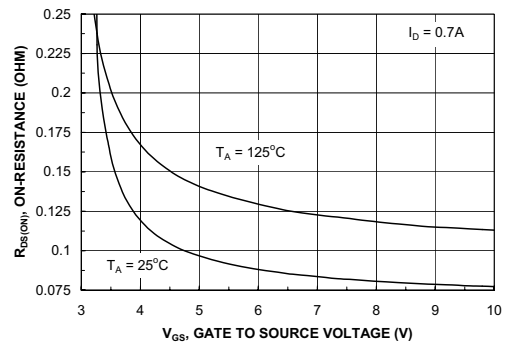

**Figure 4. On-Resistance Variation with Gate-to-Source Voltage.**

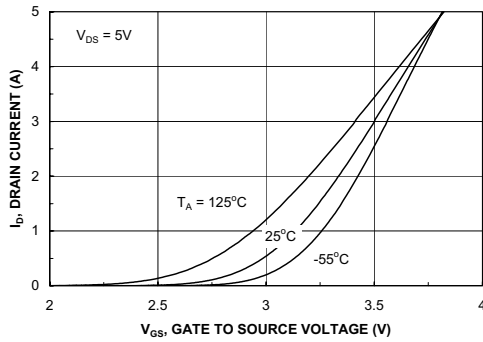

**Figure 5. Transfer Characteristics.**

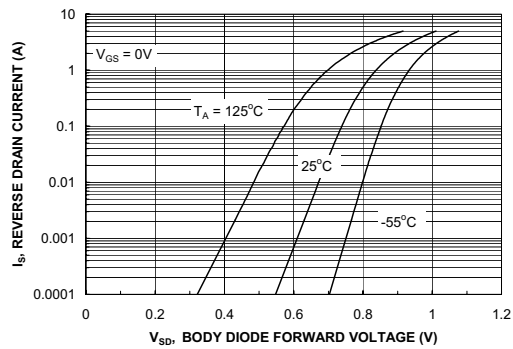

**Figure 6. Body Diode Forward Voltage Variation with Source Current and Temperature.**

Typical Characteristics

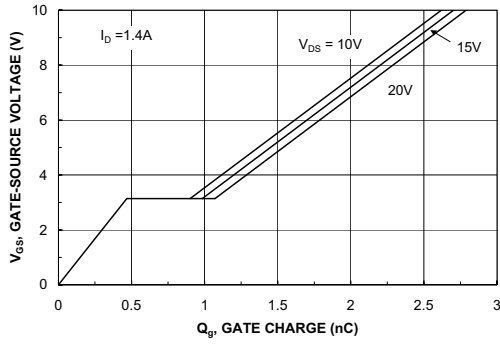

Figure 7. Gate Charge Characteristics.

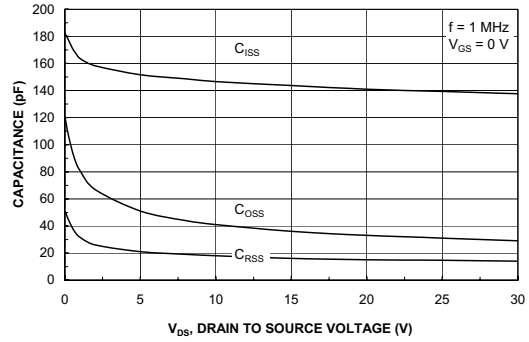

Figure 8. Capacitance Characteristics.

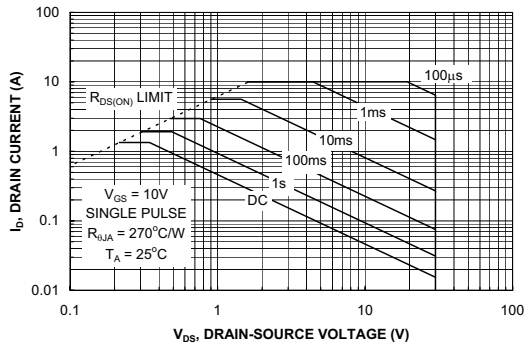

Figure 9. Maximum Safe Operating Area.

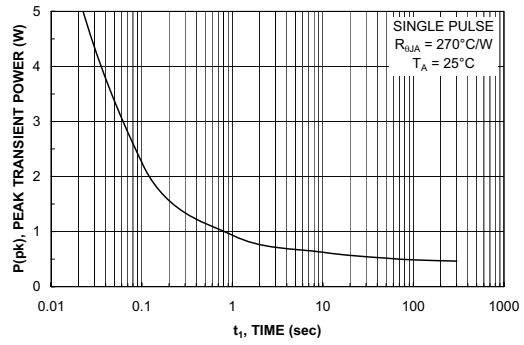

Figure 10. Single Pulse Maximum Power Dissipation.

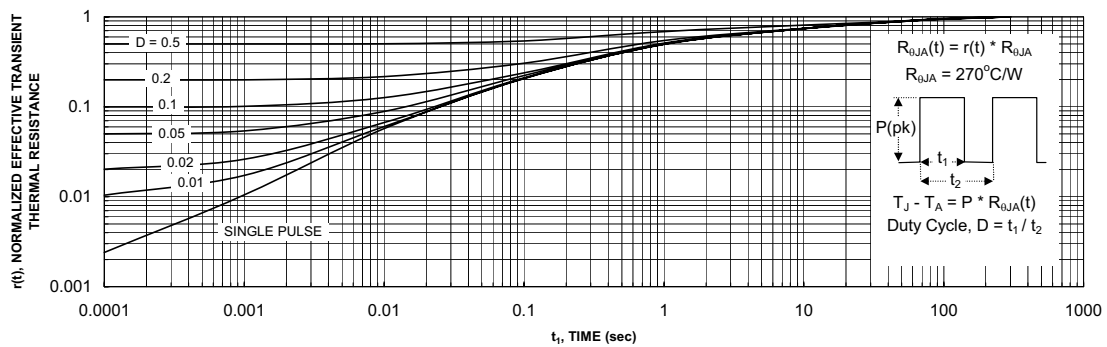
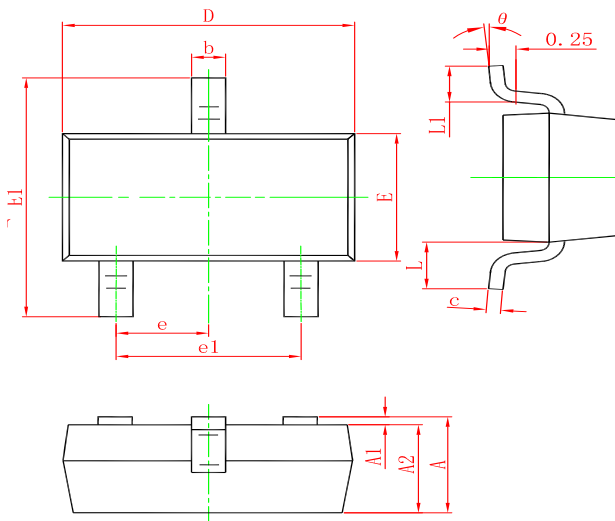

Figure 11. Transient Thermal Response Curve.

Thermal characterization performed using the conditions described in Note 1b. Transient thermal response will change depending on the circuit board design.

**SOT-23 PACKAGE OUTLINE DIMENSIONS**



Symbol	Dimensions In Millimeters		Dimensions In Inches	
	Min.	Max.	Min.	Max.
A	0.900	1.150	0.035	0.045
A1	0.000	0.100	0.000	0.004
A2	0.900	1.050	0.035	0.041
b	0.300	0.500	0.012	0.020
c	0.080	0.150	0.003	0.006
D	2.800	3.000	0.110	0.118
E	1.200	1.400	0.047	0.055
E1	2.250	2.550	0.089	0.100
e	0.950 TYP.		0.037 TYP.	
e1	1.800	2.000	0.071	0.079
L	0.550 REF.		0.022 REF.	
L1	0.300	0.500	0.012	0.020
θ	0°	8°	0°	8°

**Marking**

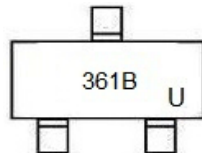

**Ordering information**

Order code	Package	Baseqty	Deliverymode
UMW FDN361BN	SOT-23	3000	Tape and reel