

Features

- $V_{DS} (V) = -40V$
- $R_{DS(ON)} < 12.3m\Omega$ ($V_{GS} = -10V$)
- $R_{DS(ON)} < 18m\Omega$ ($V_{GS} = -4.5V$)
- High performance trench technology for extremely low $r_{DS(on)}$
- RoHS Compliant

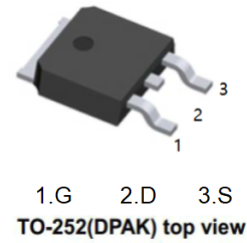

Applications

- Inverter
- Power Supplies

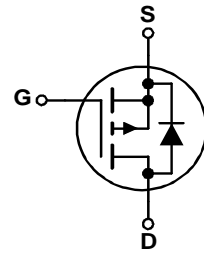

MOSFET Maximum Ratings $T_C = 25^\circ C$ unless otherwise noted

Symbol	Parameter	Conditions	Ratings	Units
V_{DS}	Drain to Source Voltage		-40	V
V_{GS}	Gate to Source Voltage		± 20	V
I_D	Drain Current	-Continuous (Package limited) $T_C = 25^\circ C$	-50	A
		-Continuous (Silicon limited) $T_C = 25^\circ C$	-58	
		-Continuous $T_A = 25^\circ C$ (Note 1a)	-10.8	
		-Pulsed	-100	
E_{AS}	Single Pulse Avalanche Energy	(Note 3)	337	mJ
P_D	Power Dissipation	$T_C = 25^\circ C$	69	W
		$T_A = 25^\circ C$ (Note 1a)	2.4	
T_J, T_{STG}	Operating and Storage Junction Temperature Range		-55 to +150	$^\circ C$

Thermal Characteristics

$R_{\theta JC}$	Thermal Resistance, Junction to Case		1.8	$^\circ C/W$
$R_{\theta JA}$	Thermal Resistance, Junction to Ambient	(Note 1a)	52	

Electrical Characteristics $T_J = 25^\circ\text{C}$ unless otherwise noted

Symbol	Parameter	Test Conditions	Min	Typ	Max	Units
--------	-----------	-----------------	-----	-----	-----	-------

Off Characteristics

BV_{DSS}	Drain to Source Breakdown Voltage	$I_D = -250\mu\text{A}, V_{GS} = 0\text{V}$	-40			V
$\Delta BV_{DSS} / \Delta T_J$	Breakdown Voltage Temperature Coefficient	$I_D = -250\mu\text{A}$, referenced to 25°C		-29		mV/ $^\circ\text{C}$
I_{DSS}	Zero Gate Voltage Drain Current	$V_{DS} = -32\text{V}, V_{GS} = 0\text{V}$			-1	μA
I_{GSS}	Gate to Source Leakage Current	$V_{GS} = \pm 20\text{V}, V_{DS} = 0\text{V}$			± 100	nA

On Characteristics

$V_{GS(th)}$	Gate to Source Threshold Voltage	$V_{GS} = V_{DS}, I_D = -250\mu\text{A}$	-1	-1.8	-3	V
$\Delta V_{GS(th)} / \Delta T_J$	Gate to Source Threshold Voltage Temperature Coefficient	$I_D = -250\mu\text{A}$, referenced to 25°C		5.8		mV/ $^\circ\text{C}$
$r_{DS(on)}$	Static Drain to Source On Resistance	$V_{GS} = -10\text{V}, I_D = -12.7\text{A}$		10.1	12.3	m Ω
		$V_{GS} = -4.5\text{V}, I_D = -10.4\text{A}$		14.5	18.0	
g_{FS}	Forward Transconductance	$V_{DS} = -5\text{V}, I_D = -12.7\text{A}$		38		S

Dynamic Characteristics

C_{iss}	Input Capacitance	$V_{DS} = -20\text{V}, V_{GS} = 0\text{V}, f = 1\text{MHz}$		2085	2775	pF
C_{oss}	Output Capacitance			360	480	pF
C_{rss}	Reverse Transfer Capacitance			210	310	pF
R_g	Gate Resistance	$f = 1\text{MHz}$		4.6		Ω

Switching Characteristics

$t_{d(on)}$	Turn-On Delay Time	$V_{DD} = -20\text{V}, I_D = -12.7\text{A}, V_{GS} = -10\text{V}, R_{GEN} = 6\Omega$		10	19	ns
t_r	Rise Time			7	13	ns
$t_{d(off)}$	Turn-Off Delay Time			38	60	ns
t_f	Fall Time			15	27	ns
Q_g	Total Gate Charge	$V_{GS} = 0\text{V to } -10\text{V}$	$V_{DD} = -20\text{V}, I_D = -12.7\text{A}$	36	50	nC
Q_g	Total Gate Charge	$V_{GS} = 0\text{V to } -5\text{V}$		19	27	nC
Q_{gs}	Gate to Source Charge			7		nC
Q_{gd}	Gate to Drain "Miller" Charge			8		nC

Drain-Source Diode Characteristics

V_{SD}	Source to Drain Diode Forward Voltage	$V_{GS} = 0\text{V}, I_S = -12.7\text{A}$ (Note 2)		-0.8	-1.2	V
t_{rr}	Reverse Recovery Time	$I_F = -12.7\text{A}, di/dt = 100\text{A}/\mu\text{s}$		29	44	ns
Q_{rr}	Reverse Recovery Charge			26	40	nC

Notes:

- 1: $R_{\theta JA}$ is the sum of the junction-to-case and case-to-ambient thermal resistance where the case thermal reference is defined as the solder mounting surface of the drain pins. $R_{\theta JC}$ is guaranteed by design while $R_{\theta JA}$ is determined by the user's board design.

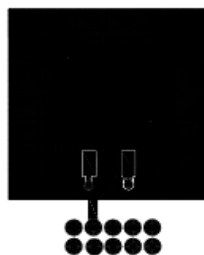

a) $52^\circ\text{C}/\text{W}$ when mounted on a 1 in^2 pad of 2 oz copper



b) $100^\circ\text{C}/\text{W}$ when mounted on a minimum pad.

- 2: Pulse Test: Pulse Width $< 300\mu\text{s}$, Duty cycle $< 2.0\%$.
 3: Starting $T_J = 25^\circ\text{C}$, $L = 3\text{mH}$, $I_{AS} = 15\text{A}$, $V_{DD} = 40\text{V}$, $V_{GS} = 10\text{V}$.

Typical Characteristics $T_J = 25^\circ\text{C}$ unless otherwise noted

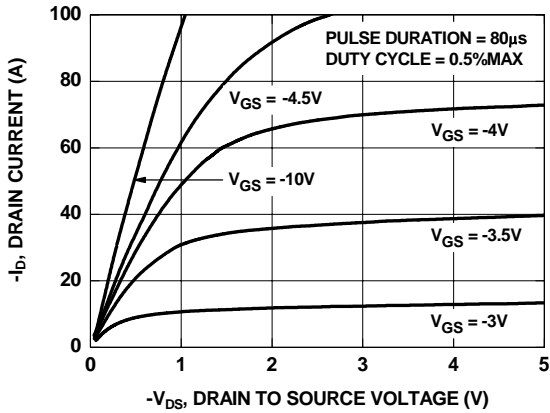

Figure 1. On-Region Characteristics

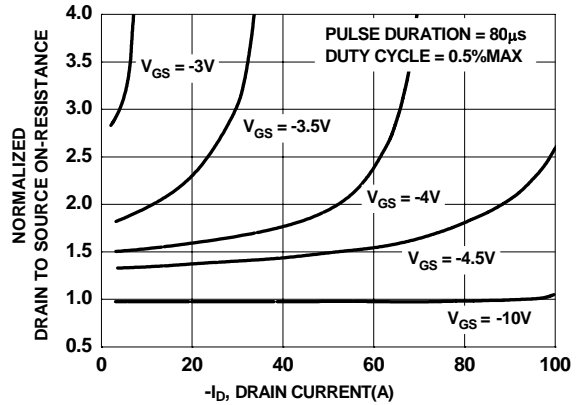

Figure 2. Normalized On-Resistance vs Drain Current and Gate Voltage

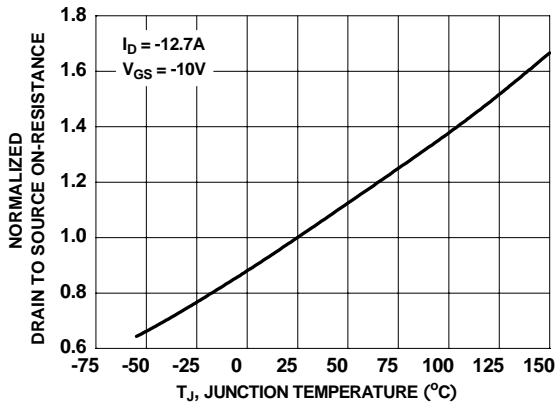

Figure 3. Normalized On-Resistance vs Junction Temperature

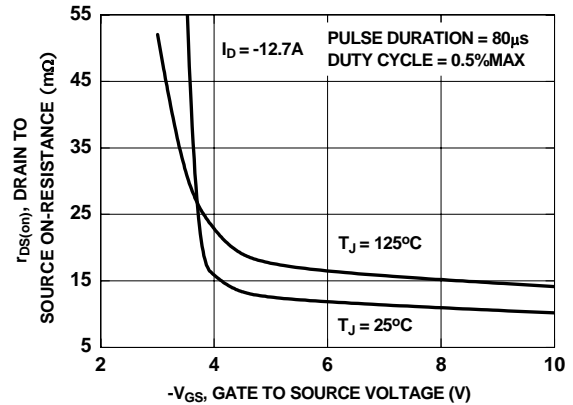

Figure 4. On-Resistance vs Gate to Source Voltage

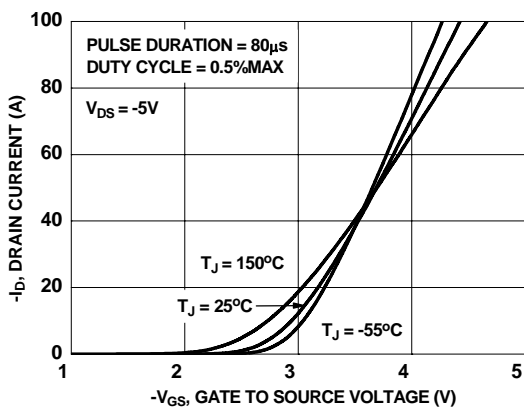

Figure 5. Transfer Characteristics

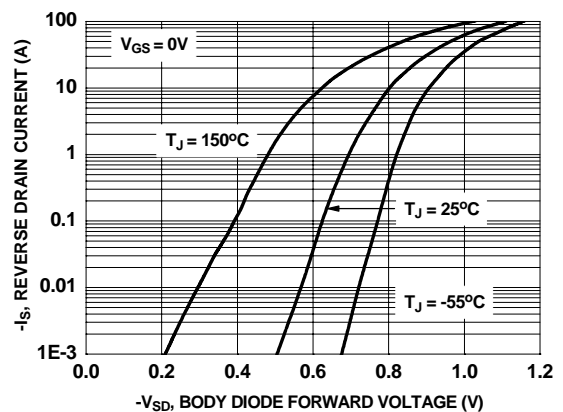

Figure 6. Source to Drain Diode Forward Voltage vs Source Current

Typical Characteristics $T_J = 25^\circ\text{C}$ unless otherwise noted

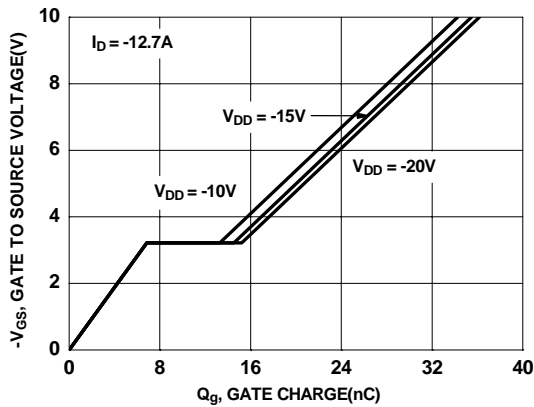

Figure 7. Gate Charge Characteristics

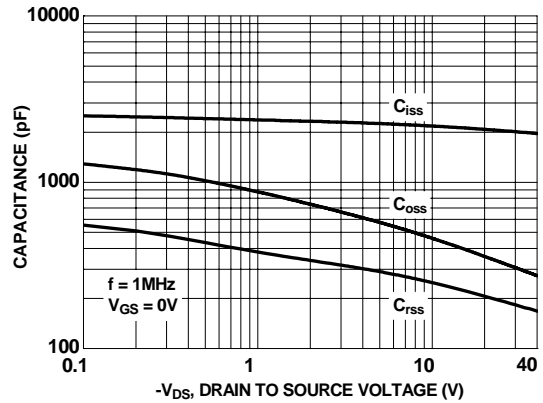

Figure 8. Capacitance vs Drain to Source Voltage

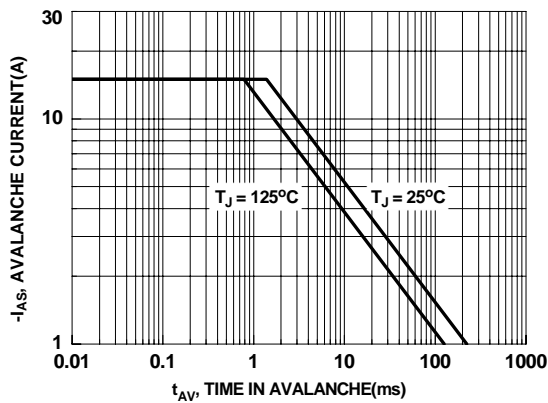

Figure 9. Unclamped Inductive Switching Capability

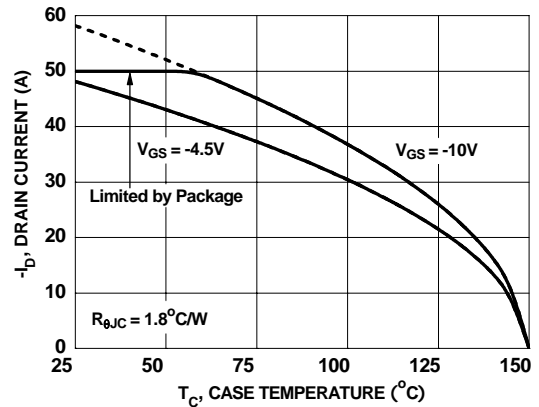

Figure 10. Maximum Continuous Drain Current vs Case Temperature

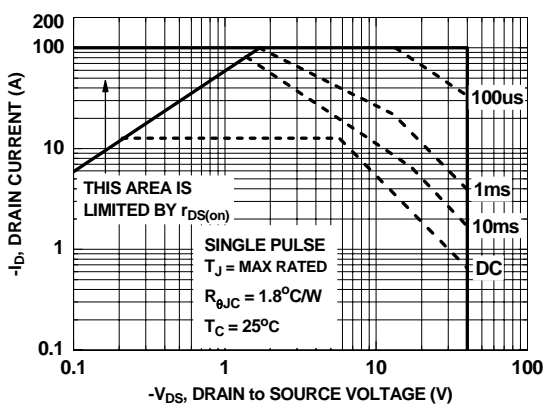

Figure 11. Forward Bias Safe Operating Area

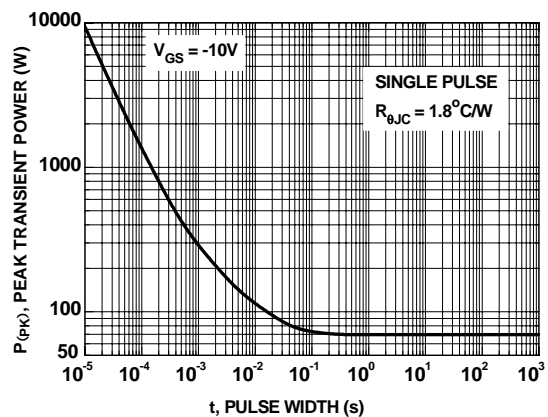

Figure 12. Single Pulse Maximum Power Dissipation

Typical Characteristics $T_J = 25^\circ\text{C}$ unless otherwise noted

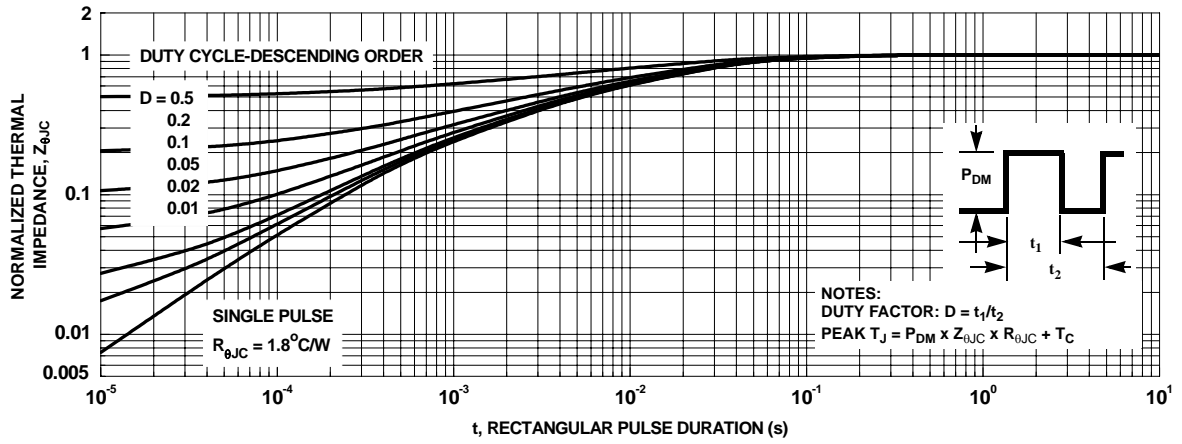
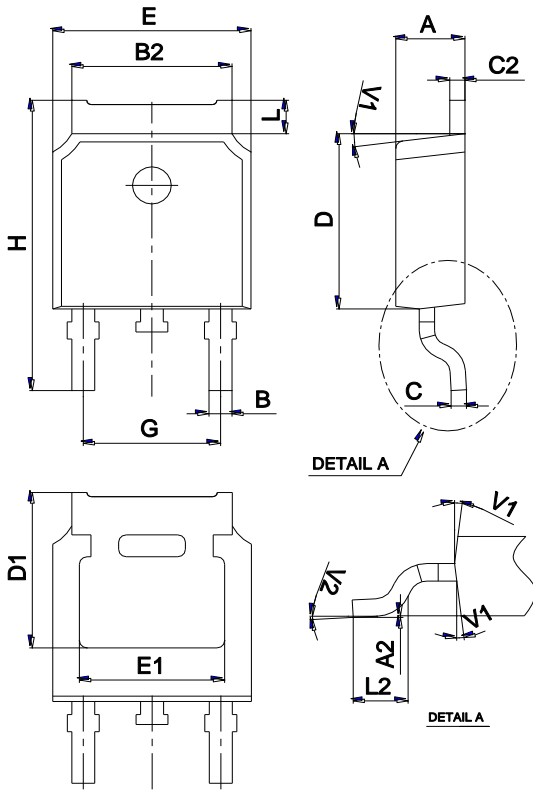

Figure 13. Transient Thermal Response Curve

Package Mechanical Data TO-252



Ref.	Dimensions					
	Millimeters			Inches		
	Min.	Typ.	Max.	Min.	Typ.	Max.
A	2.10		2.50	0.083		0.098
A2	0		0.10	0		0.004
B	0.66		0.86	0.026		0.034
B2	5.18		5.48	0.202		0.216
C	0.40		0.60	0.016		0.024
C2	0.44		0.58	0.017		0.023
D	5.90		6.30	0.232		0.248
D1	5.30REF			0.209REF		
E	6.40		6.80	0.252		0.268
E1	4.63			0.182		
G	4.47		4.67	0.176		0.184
H	9.50		10.70	0.374		0.421
L	1.09		1.21	0.043		0.048
L2	1.35		1.65	0.053		0.065
V1		7°			7°	
V2	0°		6°	0°		6°

Marking

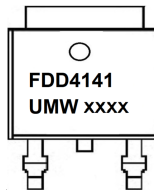

Ordering information

Order code	Package	Baseqty	Deliverymode
UMW FDD4141	TO-252	2500	Tape and reel