

Features

- $V_{DS} (V) = -30V$
- $R_{DS(ON)} < 80m\ \Omega$ ($V_{GS} = 10V$)
- $R_{DS(ON)} < 130m\Omega$ ($V_{GS} = 4.5V$)

Product Summary

- P-channel
- Enhancement mode
- Logic level (4.5V rated)
- ESD protected

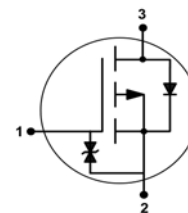
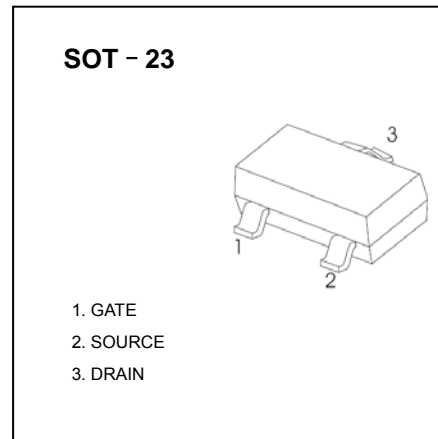

Maximum ratings, at $T_j=25\ ^\circ C$, unless otherwise specified

Parameter	Symbol	Conditions	Value	Unit
Continuous drain current	I_D	$T_A=25\ ^\circ C$	-2.0	A
		$T_A=70\ ^\circ C$	-1.6	
Pulsed drain current	$I_{D,pulse}$	$T_A=25\ ^\circ C$	-8.0	
Avalanche energy, single pulse	E_{AS}	$I_D=-2\ A, R_{GS}=25\ \Omega$	-10.7	mJ
Reverse diode dv/dt	dv/dt	$I_D=-2\ A,$ $V_{DS}=-16V,$ $di/dt=-200A/\mu s,$ $T_{j,max}=150\ ^\circ C$	6	kV/ μs
Gate source voltage	V_{GS}		± 20	V
Power dissipation ¹⁾	P_{tot}	$T_A=25\ ^\circ C$	0.5	W
Operating and storage temperature	T_j, T_{stg}		-55 ... 150	$^\circ C$
ESD Class		JESD22-A114 -HBM	2 (2kV to 4kV)	
Soldering Temperature			260 $^\circ C$	$^\circ C$
IEC climatic category; DIN IEC 68-1			55/150/56	$^\circ C$

Parameter	Symbol	Conditions	Values			Unit
			min.	typ.	max.	
Thermal characteristics						
Thermal resistance, junction - ambient	R_{thJA}	minimal footprint ¹⁾	-	-	250	K/W
Electrical characteristics, at $T_j=25\text{ }^\circ\text{C}$, unless otherwise specified						
Static characteristics						
Drain-source breakdown voltage	$V_{(BR)DSS}$	$V_{GS}=0V, I_D=-250\mu A$	-30	-	-	V
Gate threshold voltage	$V_{GS(th)}$	$V_{DS}=V_{GS}, I_D=-11\mu A$	-2.0	-1.5	-1.0	
Drain-source leakage current	I_{DSS}	$V_{DS}=-30V, V_{GS}=0V, T_j=25\text{ }^\circ\text{C}$	-	-	-1	μA
		$V_{DS}=-30V, V_{GS}=0V, T_j=150\text{ }^\circ\text{C}$	-	-	-100	
Gate-source leakage current	I_{GSS}	$V_{GS}=-20V, V_{DS}=0V$	-	-	-5	μA
Drain-source on-state resistance	$R_{DS(on)}$	$V_{GS}=-4.5V, I_D=-1.7A$	-	88	130	$m\Omega$
		$V_{GS}=-10V, I_D=-2A$	-	62	80	
Transconductance	g_{fs}	$ V_{DS} >2 I_D , R_{DS(on)max}, I_D=-1.6A$		4.6	-	S

¹⁾ Performed on 40mm² FR4 PCB. The traces are 1mm wide, 70 μ m thick and 20mm long; they are present on both sides of the PCB.

Parameter	Symbol	Conditions	Values			Unit
			min.	typ.	max.	
Dynamic characteristics						
Input capacitance	C_{iss}	$V_{GS}=0\text{ V}, V_{DS}=-15\text{ V},$ $f=1\text{ MHz}$	-	376	500	pF
Output capacitance	C_{oss}		-	196	261	
Reverse transfer capacitance	C_{rss}		-	12	18	
Turn-on delay time	$t_{d(on)}$	$V_{DD}=-15\text{ V},$ $V_{GS}=-10\text{ V},$ $I_D=-2\text{ A}, R_G=6\ \Omega$	-	5.6	-	ns
Rise time	t_r		-	7.7	-	
Turn-off delay time	$t_{d(off)}$		-	15.3	-	
Fall time	t_f		-	2.8	-	
Gate Charge Characteristics						
Gate to source charge	Q_{gs}	$V_{DD}=-15\text{ V}, I_D=-2\text{ A},$ $V_{GS}=0\text{ to }-10\text{ V}$	-	-1.2	-	nC
Gate to drain charge	Q_{gd}		-	-0.6	-	
Gate charge total	Q_g		-	-5.0	-	
Gate plateau voltage	$V_{plateau}$		-	-3.1	-	V
Reverse Diode						
Diode continuous forward current	I_S	$T_A=25\text{ }^\circ\text{C}$	-	-	-0.4	A
Diode pulse current	$I_{S,pulse}$		-	-	-8.4	
Diode forward voltage	V_{SD}	$V_{GS}=0\text{ V}, I_F=-2\text{ A},$ $T_j=25\text{ }^\circ\text{C}$	-	-0.8	-1.1	V
Reverse recovery time	t_{rr}	$V_R=10\text{ V}, I_F=-2\text{ A},$ $di_F/dt=100\text{ A}/\mu\text{s}$	-	14	-	ns
Reverse recovery charge	Q_{rr}		-	-5.9	-	nC

Typical Electrical Characteristics

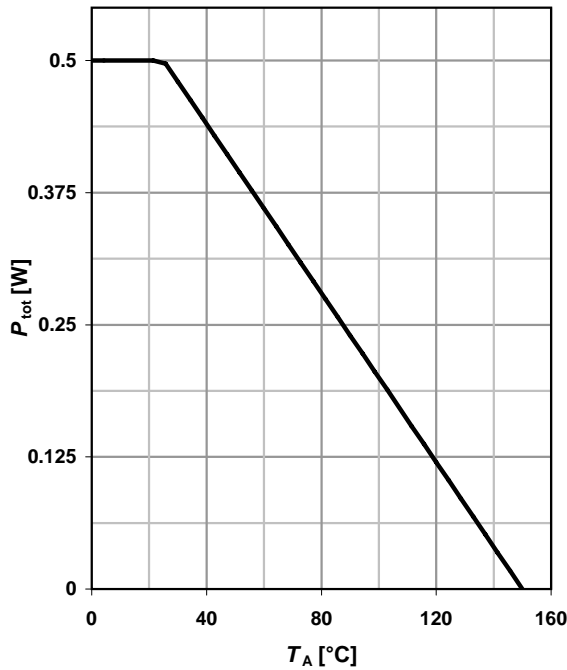

1 Power dissipation

$P_{tot}=f(T_A)$

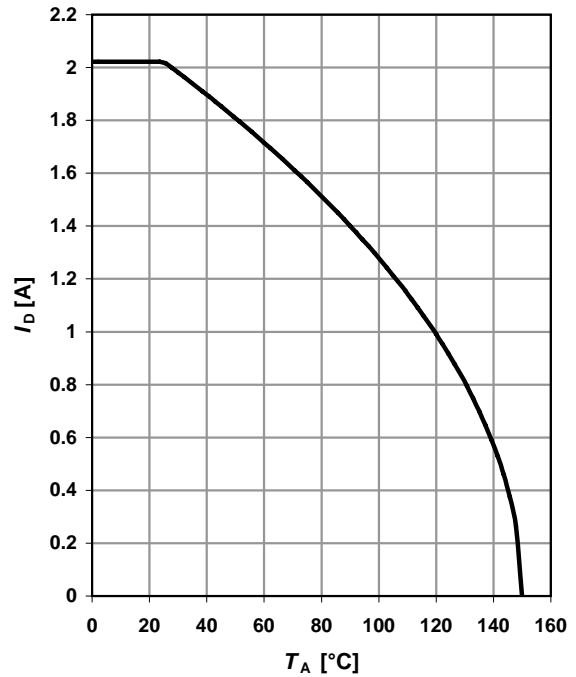

2 Drain current

$I_D=f(T_A); V_{GS} \geq 10\text{ V}$

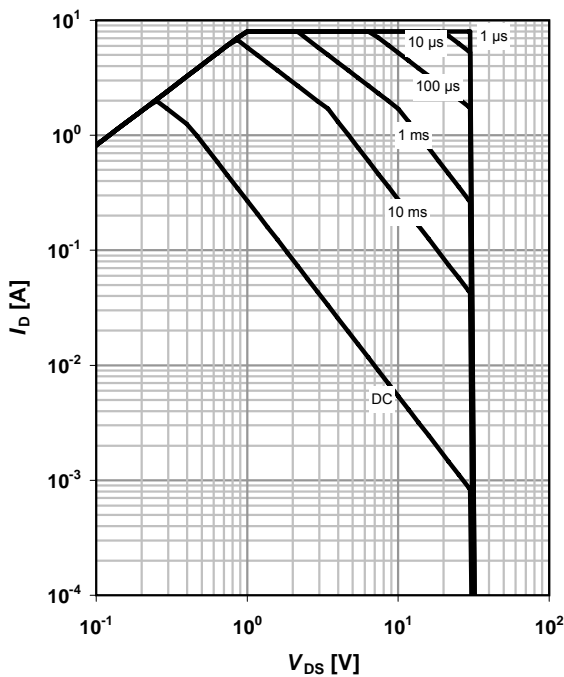

3 Safe operating area

$I_D=f(V_{DS}); T_A=25\text{ °C}; D=0$

parameter: t_p

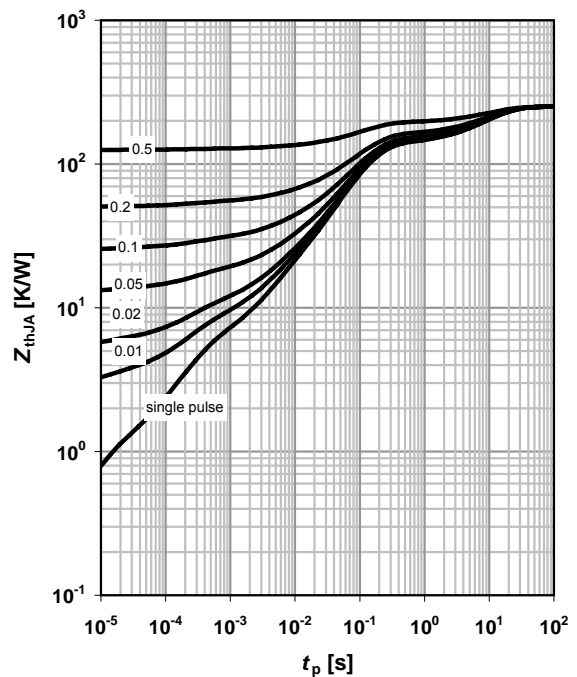

4 Max. transient thermal impedance

$Z_{thJA}=f(t_p)$

parameter: $D=t_p/T$

Typical Electrical Characteristics

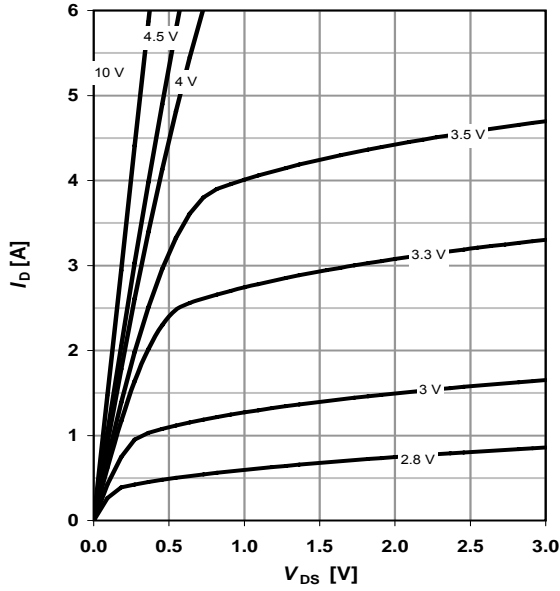

5 Typ. output characteristics

$I_D = f(V_{DS}); T_j = 25\text{ °C}$
parameter: V_{GS}

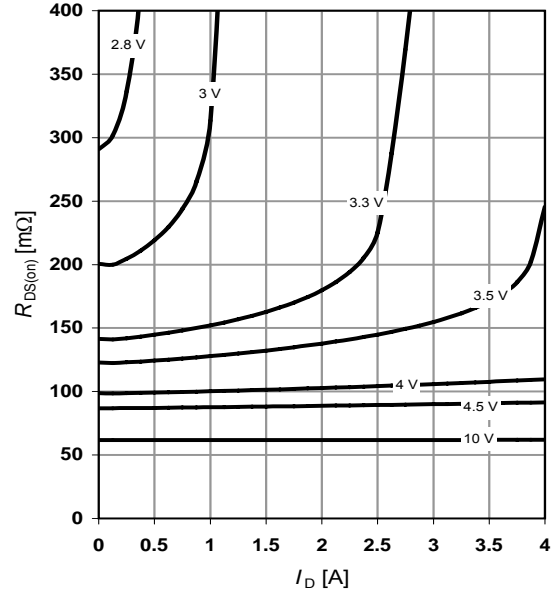

6 Typ. drain-source on resistance

$R_{DS(on)} = f(I_D); T_j = 25\text{ °C}$
parameter: V_{GS}

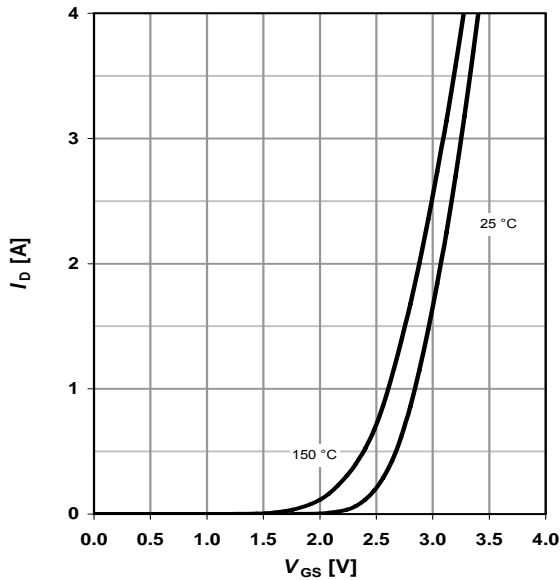

7 Typ. transfer characteristics

$I_D = f(V_{GS}); |V_{DS}| > 2|I_D|R_{DS(on)max}$

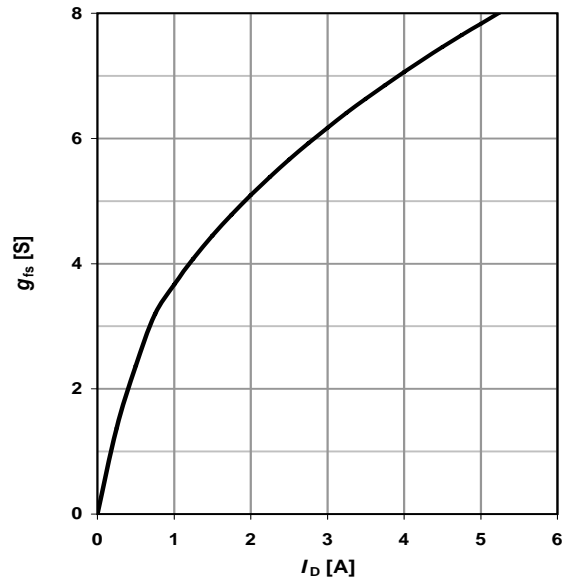

8 Typ. forward transconductance

$g_{fs} = f(I_D); T_j = 25\text{ °C}$

Typical Electrical Characteristics

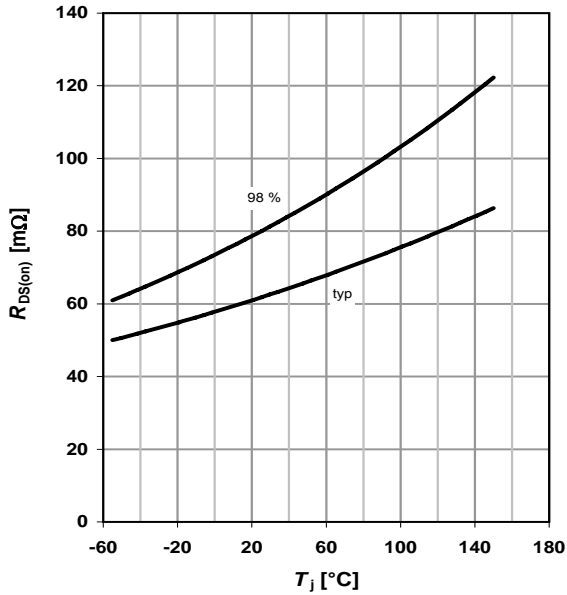

9 Drain-source on-state resistance

$$R_{DS(on)} = f(T_j); I_D = -2 \text{ A}; V_{GS} = -10 \text{ V}$$

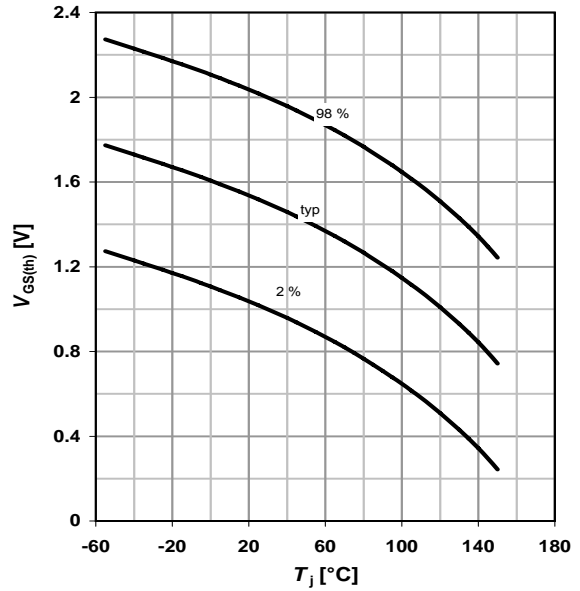

10 Typ. gate threshold voltage

$$V_{GS(th)} = f(T_j); V_{DS} = V_{GS}; I_D = 11 \mu\text{A}$$

parameter: I_D

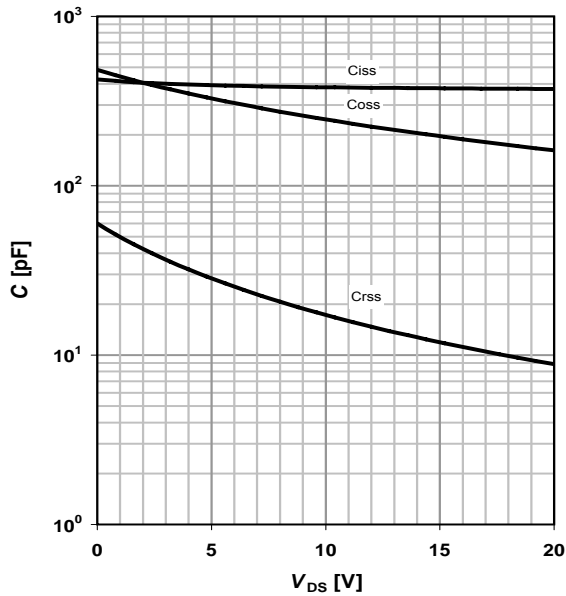

11 Typ. capacitances

$$C = f(V_{DS}); V_{GS} = 0 \text{ V}; f = 1 \text{ MHz}; T_j = 25^\circ\text{C}$$

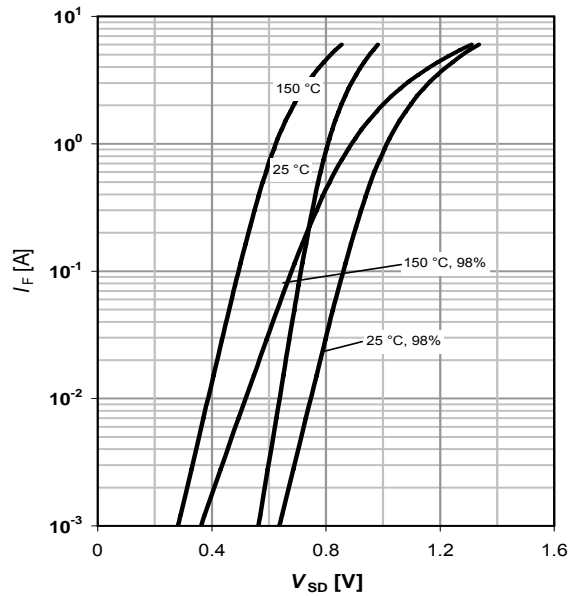

12 Forward characteristics of reverse diode

$$I_F = f(V_{SD})$$

parameter: T_j

Typical Electrical Characteristics

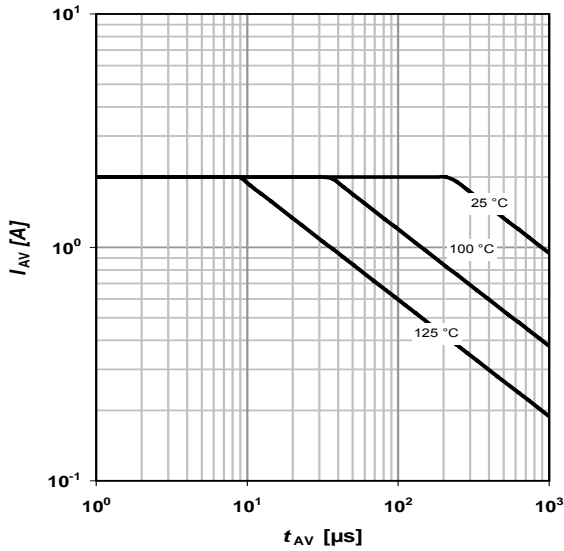

13 Avalanche characteristics

$I_{AS}=f(t_{AV}); R_{GS}=25 \Omega$

parameter: $T_{j(start)}$

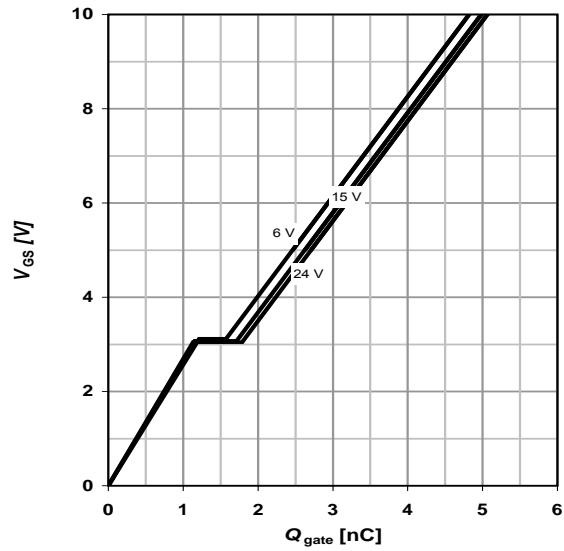

14 Typ. gate charge

$V_{GS}=f(Q_{gate}); I_D=-2 \text{ A pulsed}$

parameter: V_{DD}

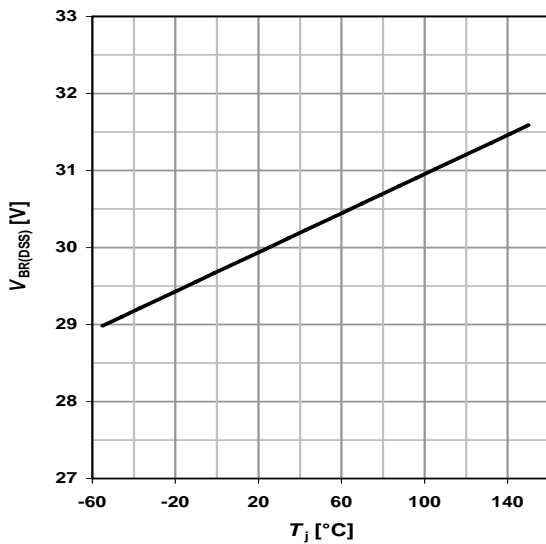

15 Drain-source breakdown voltage

$V_{BR(DSS)}=f(T_j); I_D=250 \mu\text{A}$

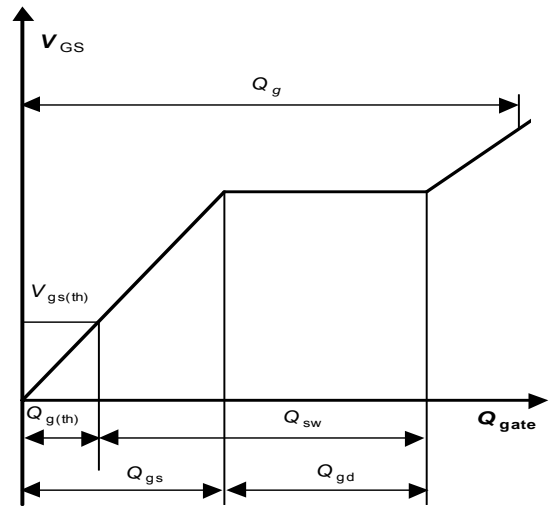

16 Gate charge waveforms

SOT-23 PACKAGE OUTLINE DIMENSIONS

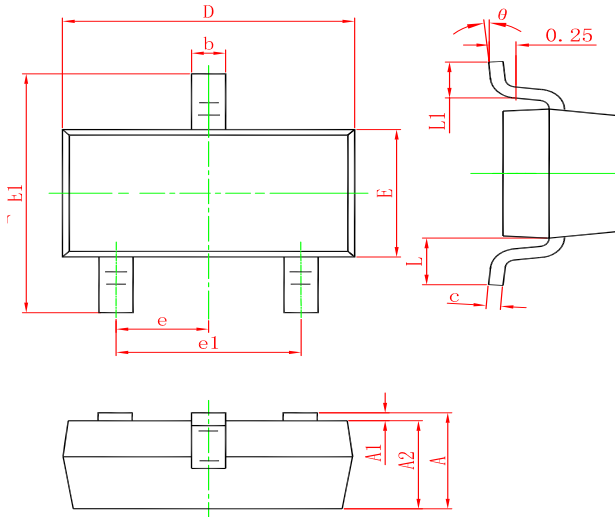

Symbol	Dimensions In Millimeters		Dimensions In Inches	
	Min.	Max.	Min.	Max.
A	0.900	1.150	0.035	0.045
A1	0.000	0.100	0.000	0.004
A2	0.900	1.050	0.035	0.041
b	0.300	0.500	0.012	0.020
c	0.080	0.150	0.003	0.006
D	2.800	3.000	0.110	0.118
E	1.200	1.400	0.047	0.055
E1	2.250	2.550	0.089	0.100
e	0.950 TYP.		0.037 TYP.	
e1	1.800	2.000	0.071	0.079
L	0.550 REF.		0.022 REF.	
L1	0.300	0.500	0.012	0.020
θ	0°	8°	0°	8°

Marking

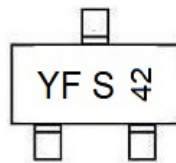

Ordering information

Order code	Package	Baseqty	Deliverymode
UMW BSS308PE	SOT-23	3000	Tape and reel