

General Description

The AO4826 uses advanced trench technology to provide excellent $R_{DS(ON)}$ and low gate charge. This device is suitable for use as a load switch or in PWM applications.

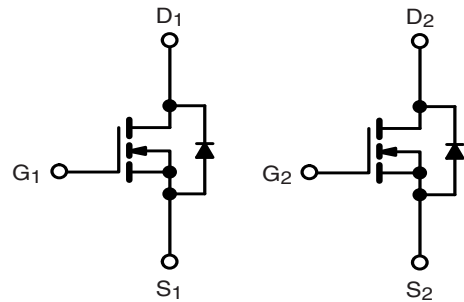

General Features

$V_{DS} = 60V$ $I_D = 6.3 A$

$R_{DS(ON)} < 25m\Omega$ @ $V_{GS}=10V$

$R_{DS(ON)} < 30m\Omega$ @ $V_{GS}=4.5V$

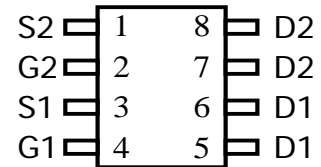

ABSOLUTE MAXIMUM RATINGS ($T_C = 25\text{ }^\circ\text{C}$, unless otherwise noted)

PARAMETER	SYMBOL	LIMIT	UNIT
Drain-Source Voltage	V_{DS}	60	V
Gate-Source Voltage	V_{GS}	± 20	
Continuous Drain Current	I_D	$T_C = 25\text{ }^\circ\text{C}$	7
		$T_C = 125\text{ }^\circ\text{C}$	4
Continuous Source Current (Diode Conduction) ^a	I_S	3.6	A
Pulsed Drain Current ^b	I_{DM}	28	
Single Pulse Avalanche Current	I_{AS}	18	
Single Pulse Avalanche Energy	E_{AS}	16.2	mJ
Maximum Power Dissipation ^b	P_D	$T_C = 25\text{ }^\circ\text{C}$	4
		$T_C = 125\text{ }^\circ\text{C}$	1.3
Operating Junction and Storage Temperature Range	T_J, T_{stg}	-55 to +175	$^\circ\text{C}$

THERMAL RESISTANCE RATINGS

PARAMETER	SYMBOL	LIMIT	UNIT
Junction-to-Ambient	R_{thJA}	110	$^\circ\text{C/W}$
Junction-to-Foot (Drain)	R_{thJF}	34	

Notes

- Package limited.
- Pulse test; pulse width $\leq 300\text{ }\mu\text{s}$, duty cycle $\leq 2\%$.
- When mounted on 1" square PCB (FR4 material).

SPECIFICATIONS $T_C = 25\text{ }^\circ\text{C}$, unless otherwise noted)

PARAMETER	SYMBOL	TEST CONDITIONS		MIN.	TYP.	MAX.	UNIT
Drain-Source Breakdown Voltage	V_{DS}	$V_{GS} = 0\text{ V}, I_D = 250\text{ }\mu\text{A}$		60	-	-	V
Gate-Source Threshold Voltage	$V_{GS(th)}$	$V_{DS} = V_{GS}, I_D = 250\text{ }\mu\text{A}$		1	1.5	2.5	
Gate-Source Leakage	I_{GSS}	$V_{DS} = 0\text{ V}, V_{GS} = \pm 20\text{ V}$		-	-	± 100	nA
Zero Gate Voltage Drain Current	I_{DSS}	$V_{GS} = 0\text{ V}$	$V_{DS} = 60\text{ V}$	-	-	1	μA
		$V_{GS} = 0\text{ V}$	$V_{DS} = 60\text{ V}, T_J = 125\text{ }^\circ\text{C}$	-	-	50	
		$V_{GS} = 0\text{ V}$	$V_{DS} = 60\text{ V}, T_J = 175\text{ }^\circ\text{C}$	-	-	150	
On-State Drain Current ^a	$I_{D(on)}$	$V_{GS} = 10\text{ V}$	$V_{DS} \geq 5\text{ V}$	20	-	-	A
Drain-Source On-State Resistance ^a	$R_{DS(on)}$	$V_{GS} = 10\text{ V}$	$I_D = 4.5\text{ A}$		20	25	$\text{m}\Omega$
		$V_{GS} = 4.5\text{ V}$	$I_D = 4\text{ A}$		22	30	
Forward Transconductance ^f	g_{fs}	$V_{DS} = 15\text{ V}, I_D = 4.5\text{ A}$		-	15	-	S
Input Capacitance	C_{iss}	$V_{GS} = 0\text{ V}$	$V_{DS} = 25\text{ V}, f = 1\text{ MHz}$	-	600	750	pF
Output Capacitance	C_{oss}			-	110	140	
Reverse Transfer Capacitance	C_{rss}			-	50	62	
Total Gate Charge ^c	Q_g	$V_{GS} = 10\text{ V}$	$V_{DS} = 30\text{ V}, I_D = 5.3\text{ A}$	-	11.7	18	nC
Gate-Source Charge ^c	Q_{gs}			-	1.8	2.7	
Gate-Drain Charge ^c	Q_{gd}			-	2.8	4.2	
Gate Resistance	R_g	$f = 1\text{ MHz}$		1.3	-	6	Ω
Turn-On Delay Time ^c	$t_{d(on)}$	$V_{DD} = 30\text{ V}, R_L = 6.8\text{ }\Omega$ $I_D \cong 4.4\text{ A}, V_{GEN} = 10\text{ V}, R_g = 1\text{ }\Omega$		-	7	11	ns
Rise Time ^c	t_r			-	3.3	5	
Turn-Off Delay Time ^c	$t_{d(off)}$			-	22.4	33.5	
Fall Time ^c	t_f			-	2.1	3.2	
Pulsed Current ^a	I_{SM}^b			-	-	28	A
Forward Voltage	V_{SD}	$I_F = 2\text{ A}, V_{GS} = 0\text{ V}$		-	0.75	1.1	V

Notes

- Pulse test; pulse width $\leq 300\text{ }\mu\text{s}$, duty cycle $\leq 2\%$.
- Guaranteed by design, not subject to production testing.
- Independent of operating temperature.

TYPICAL CHARACTERISTICS ($T_A = 25\text{ }^\circ\text{C}$, unless otherwise noted)

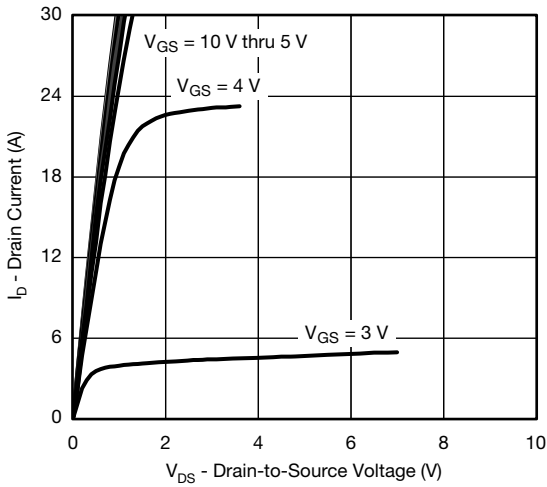

Output Characteristics

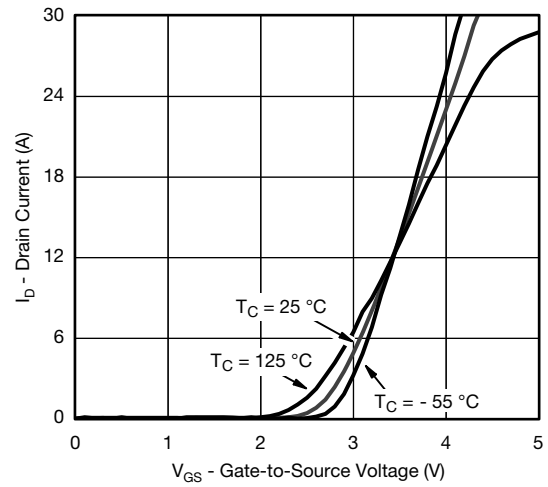

Transfer Characteristics

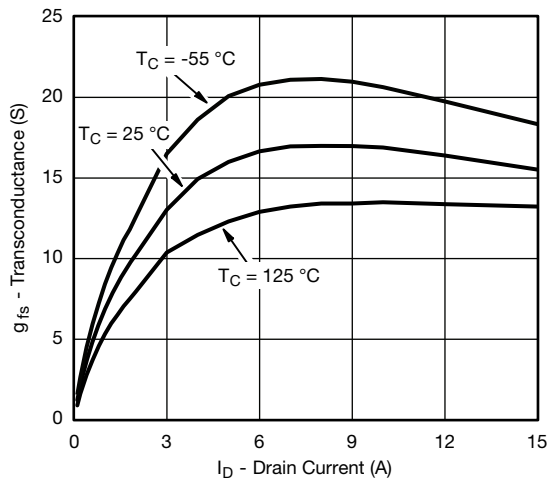

Transconductance

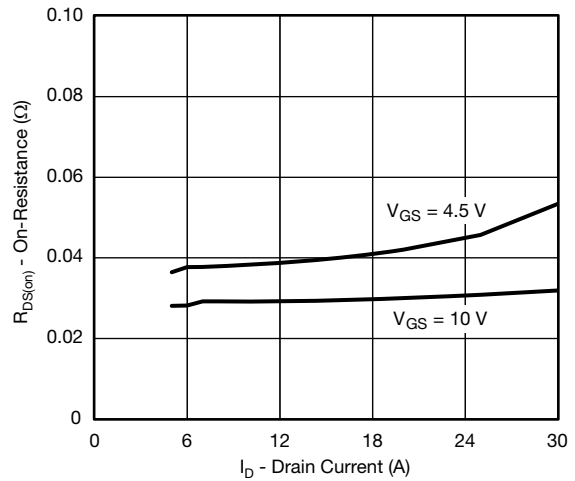

On-Resistance vs. Drain Current

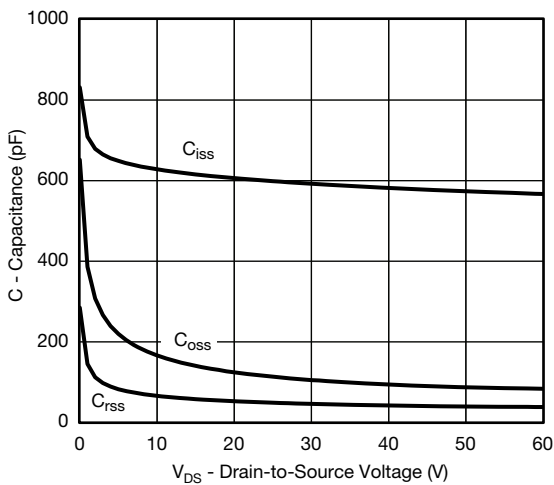

Capacitance

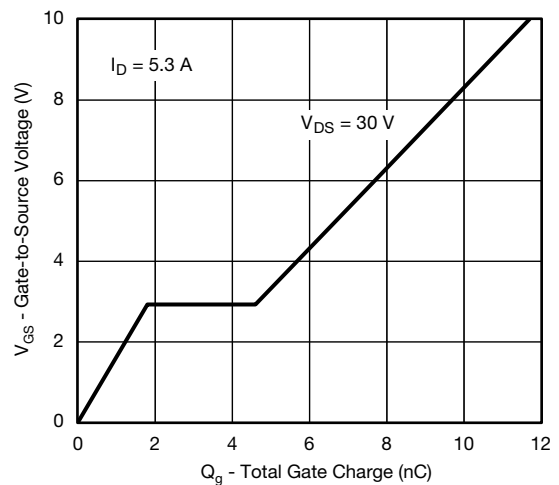

Gate Charge

TYPICAL CHARACTERISTICS ($T_A = 25\text{ }^\circ\text{C}$, unless otherwise noted)

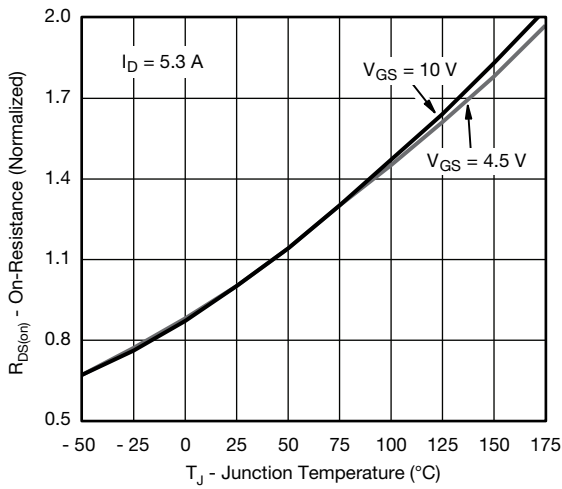

On-Resistance vs. Junction Temperature

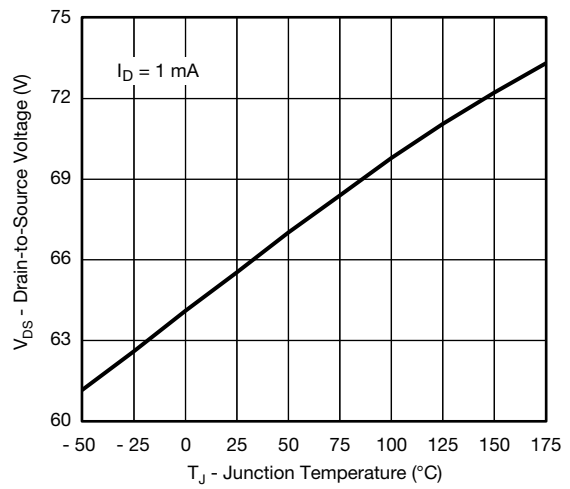

Drain Source Breakdown vs. Junction Temperature

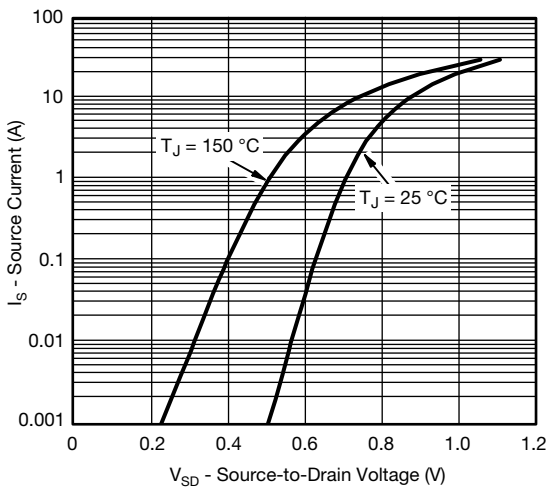

Source Drain Diode Forward Voltage

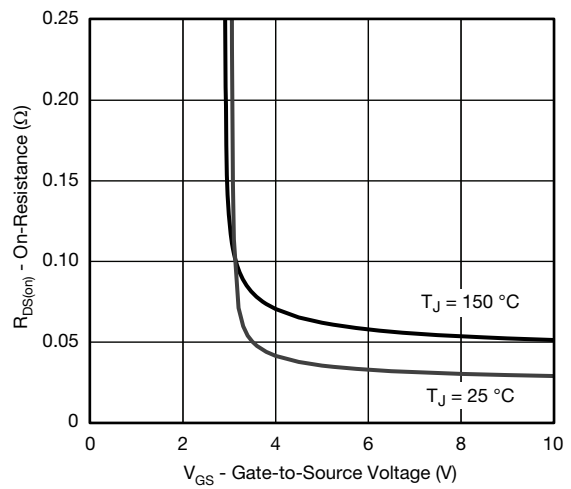

On-Resistance vs. Gate-to-Source Voltage

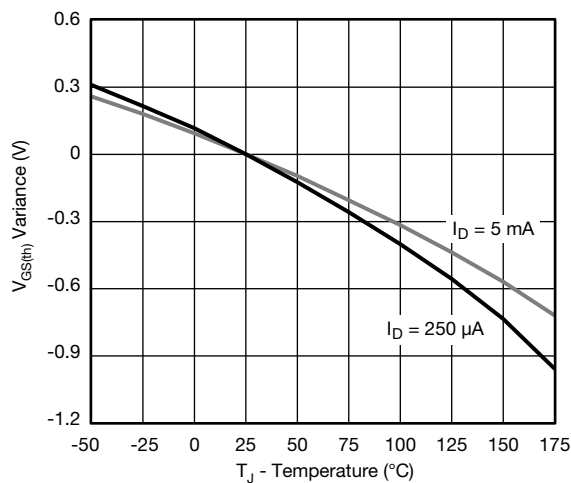

Threshold Voltage

THERMAL RATINGS ($T_A = 25\text{ }^\circ\text{C}$, unless otherwise noted)

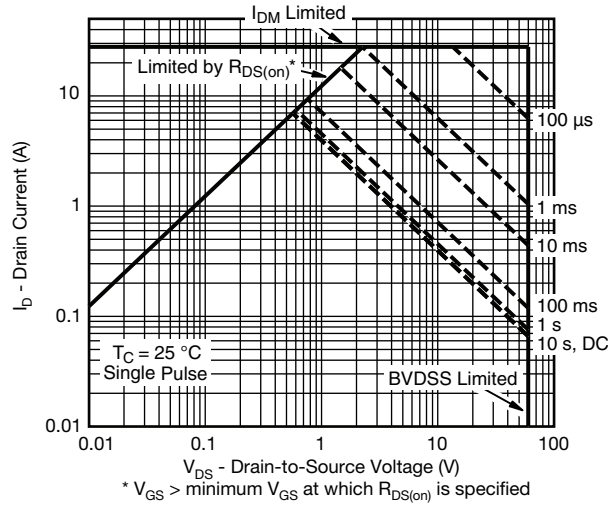

Safe Operating Area

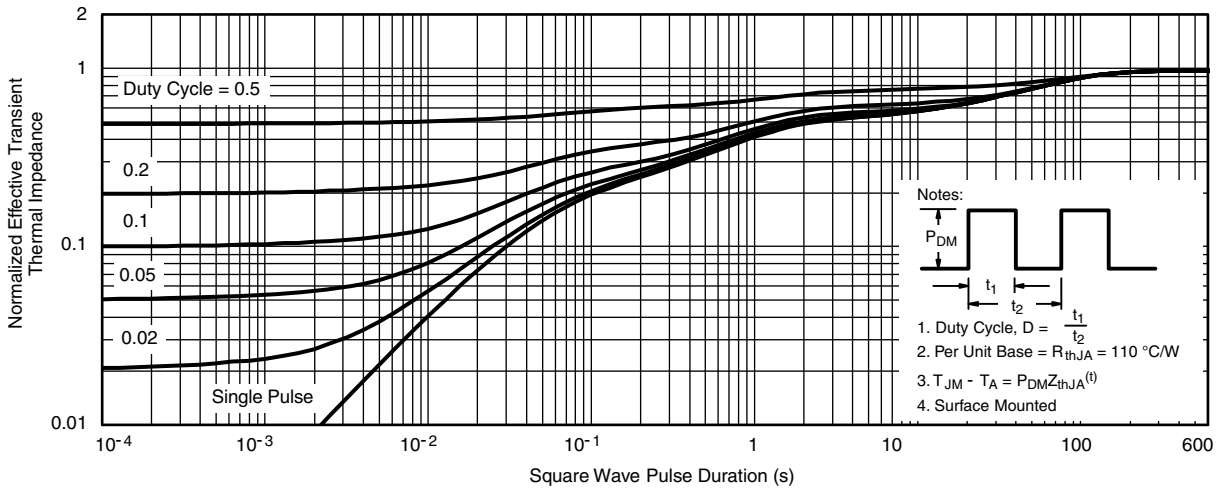

Normalized Thermal Transient Impedance, Junction-to-Ambient

THERMAL RATINGS ($T_A = 25\text{ }^\circ\text{C}$, unless otherwise noted)

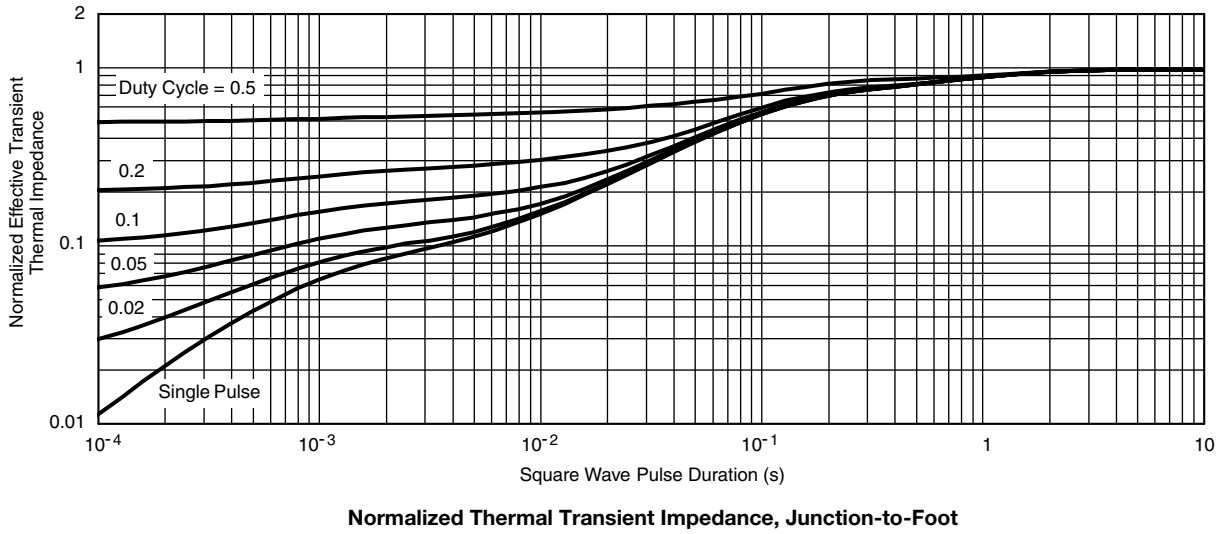

PACKAGE OUTLINE DIMENSIONS

SOP-8

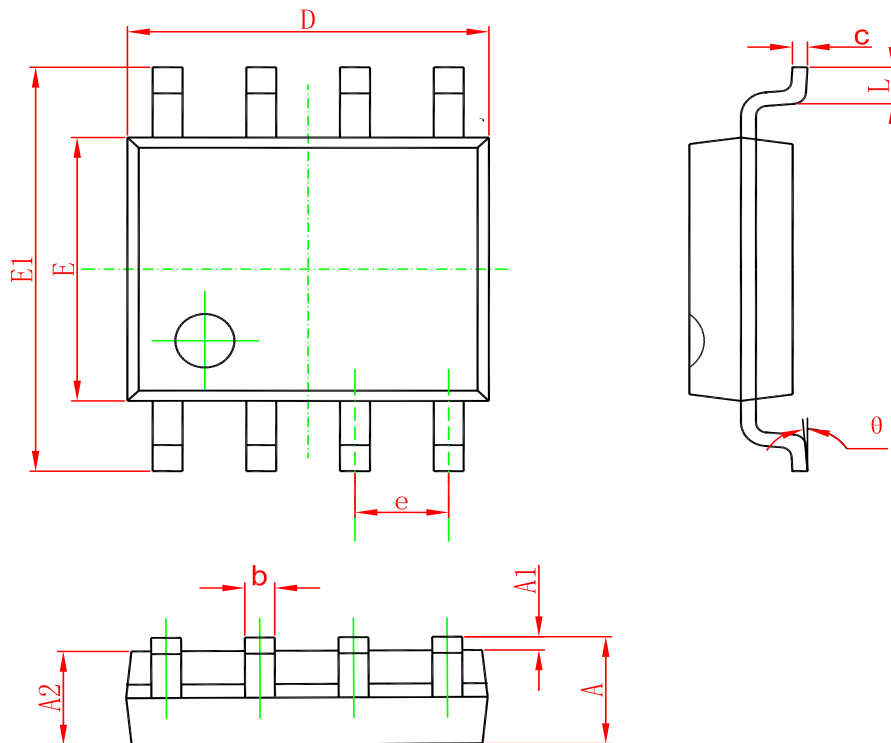

Symbol	Dimensions In Millimeters		Dimensions In Inches	
	Min	Max	Min	Max
A	1.350	1.750	0.053	0.069
A1	0.100	0.250	0.004	0.010
A2	1.350	1.550	0.053	0.061
b	0.330	0.510	0.013	0.020
c	0.170	0.250	0.006	0.010
D	4.700	5.100	0.185	0.200
E	3.800	4.000	0.150	0.157
E1	5.800	6.200	0.228	0.244
e	1.270(BSC)		0.050(BSC)	
L	0.400	1.270	0.016	0.050
θ	0°	8°	0°	8°

Marking

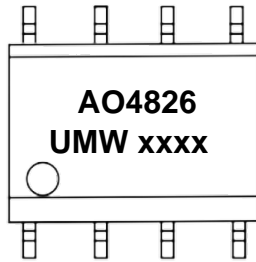

("xxxx"代表年份周期)

Ordering information

Order code	Package	Baseqty	Deliverymode
UMW AO4826	SOP-8	3000	Tape and reel