

General Description

The AO4807 uses advanced trench technology to provide excellent $R_{DS(ON)}$, and ultra-low low gate charge. This device is suitable for use as a load switch or in PWM applications.

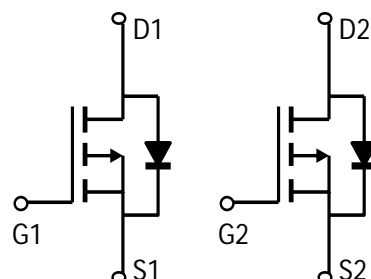

Features

- V_{DS} (V) = -30V
- I_D = -6 A (V_{GS} = -10V)
- $R_{DS(ON)}$ < 21m Ω (V_{GS} = 10V)
- $R_{DS(ON)}$ < 30m Ω (V_{GS} = 4.5V)

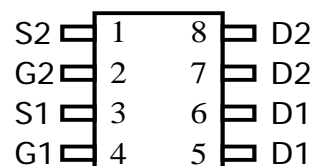

Absolute Maximum Ratings $T_A=25^\circ\text{C}$ unless otherwise noted

Parameter	Symbol	Maximum	Units
Drain-Source Voltage	V_{DS}	-30	V
Gate-Source Voltage	V_{GS}	± 20	V
Continuous Drain Current ^A	$T_A=25^\circ\text{C}$	-6	A
	$T_A=70^\circ\text{C}$	-5	
Pulsed Drain Current ^B	I_{DM}	-30	
Power Dissipation ^A	$T_A=25^\circ\text{C}$	2	W
	$T_A=70^\circ\text{C}$	1.44	
Junction and Storage Temperature Range	T_J, T_{STG}	-55 to 150	$^\circ\text{C}$

Thermal Characteristics

Parameter	Symbol	Typ	Max	Units
Maximum Junction-to-Ambient ^A	$R_{\theta JA}$	48	62.5	$^\circ\text{C/W}$
Maximum Junction-to-Ambient ^A		Steady-State	74	
Maximum Junction-to-Lead ^C	$R_{\theta JL}$	35	40	$^\circ\text{C/W}$

Electrical Characteristics (T_J=25°C unless otherwise noted)

Symbol	Parameter	Conditions	Min	Typ	Max	Units
BV _{DSS}	Drain-Source Breakdown Voltage	I _D =-250μA, V _{GS} =0V	-30			V
I _{DSS}	Zero Gate Voltage Drain Current	V _{DS} =-24V, V _{GS} =0V T _J =55°C			-1 -5	μA
I _{GSS}	Gate-Body leakage current	V _{DS} =0V, V _{GS} =±20V			±100	nA
V _{GS(th)}	Gate Threshold Voltage	V _{DS} =V _{GS} , I _D =-250μA	-1	-1.5	-2.5	V
I _{D(ON)}	On state drain current	V _{GS} =-10V, V _{DS} =-5V	-30			A
R _{DS(ON)}	Static Drain-Source On-Resistance	V _{GS} =-10V, I _D =-6A		19	25	mΩ
		V _{GS} =-4.5V, I _D =-5A		25	30	mΩ
g _{FS}	Forward Transconductance	V _{DS} =-5V, I _D =-6A		13		S
V _{SD}	Diode Forward Voltage	I _S =-1A, V _{GS} =0V		-0.76	-1	V
I _S	Maximum Body-Diode Continuous Current				-4.2	A
C _{iss}	Input Capacitance	V _{GS} =0V, V _{DS} =-15V, f=1MHz		920		pF
C _{oss}	Output Capacitance			190		pF
C _{rss}	Reverse Transfer Capacitance			122		pF
R _g	Gate resistance	V _{GS} =0V, V _{DS} =0V, f=1MHz		3.6		Ω
Q _{g(10V)}	Total Gate Charge (10V)	V _{GS} =-10V, V _{DS} =-15V, I _D =-6A		18.5		nC
Q _{g(4.5V)}	Total Gate Charge (4.5V)			9.6		nC
Q _{gs}	Gate Source Charge			2.7		nC
Q _{gd}	Gate Drain Charge			4.5		nC
t _{D(on)}	Turn-On DelayTime	V _{GS} =-10V, V _{DS} =-15V, R _L =2.7Ω, R _{GEN} =3Ω		7.7		ns
t _r	Turn-On Rise Time			5.7		ns
t _{D(off)}	Turn-Off DelayTime			20.2		ns
t _f	Turn-Off Fall Time			9.5		ns
t _{rr}	Body Diode Reverse Recovery Time	I _F =-6A, dI/dt=100A/μs		20		ns
Q _{rr}	Body Diode Reverse Recovery Charge	I _F =-6A, dI/dt=100A/μs		8.8		nC

A: The value of R_{θJA} is measured with the device mounted on 1in² FR-4 board with 2oz. Copper, in a still air environment with T_A=25°C. The value in any given application depends on the user's specific board design. The current rating is based on the t_s ≤ 10s thermal resistance rating.

B: Repetitive rating, pulse width limited by junction temperature.

C: The R_{θJA} is the sum of the thermal impedance from junction to lead R_{θJL} and lead to ambient.

D: The static characteristics in Figures 1 to 6,12,14 are obtained using 80μs pulses, duty cycle 0.5% max.

E: These tests are performed with the device mounted on 1 in² FR-4 board with 2oz. Copper, in a still air environment with T_A=25°C. The SOA curve provides a single pulse rating.

TYPICAL ELECTRICAL AND THERMAL CHARACTERISTICS

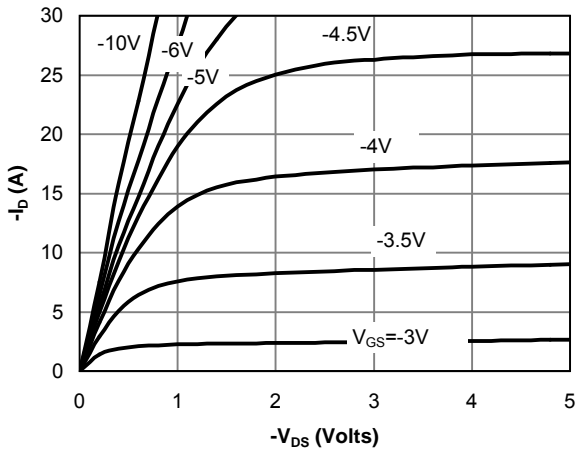

Fig 1: On-Region Characteristics

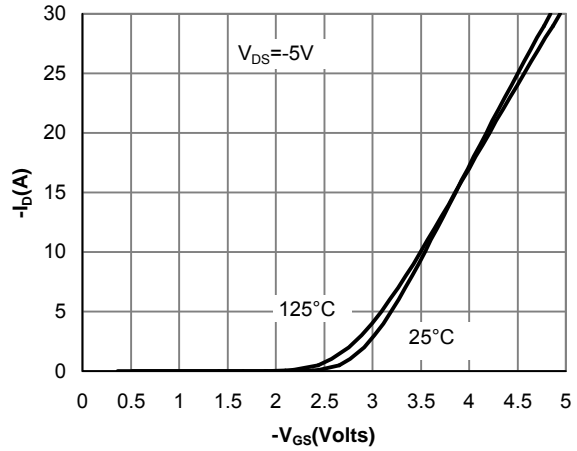

Figure 2: Transfer Characteristics

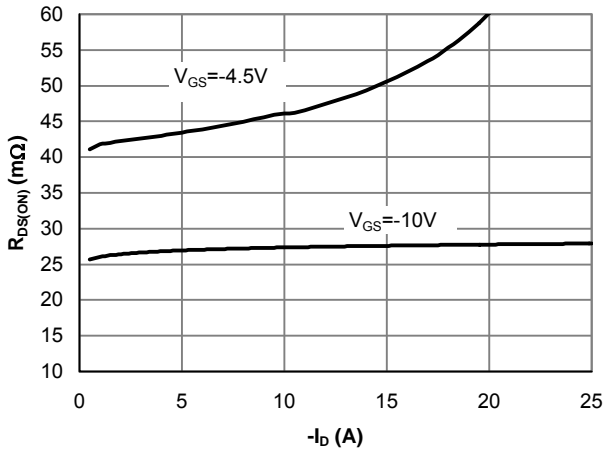

Figure 3: On-Resistance vs. Drain Current and Gate Voltage

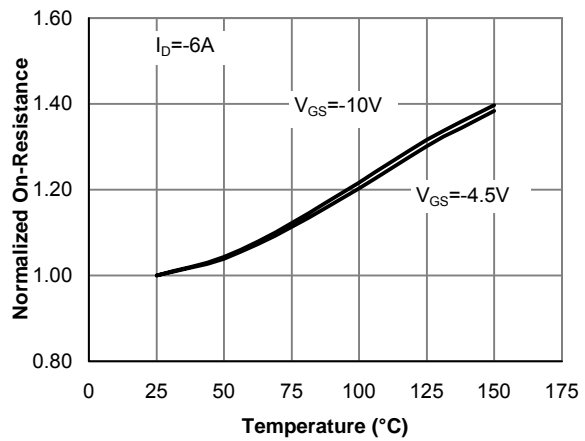

Figure 4: On-Resistance vs. Junction Temperature

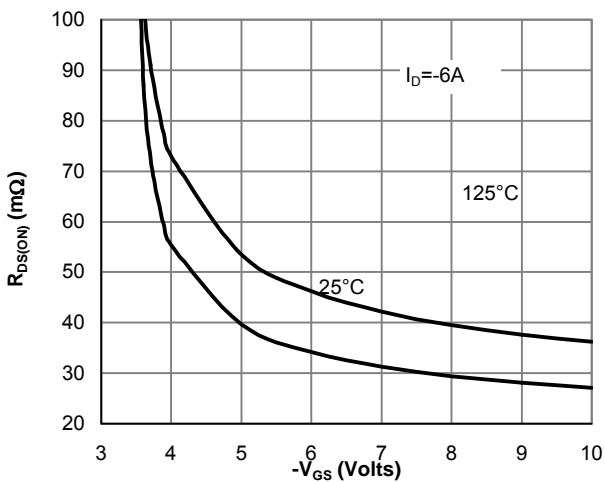

Figure 5: On-Resistance vs. Gate-Source Voltage

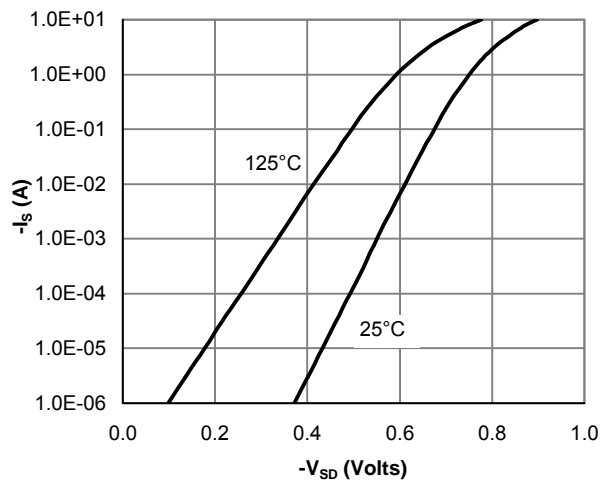

Figure 6: Body-Diode Characteristics

TYPICAL ELECTRICAL AND THERMAL CHARACTERISTICS

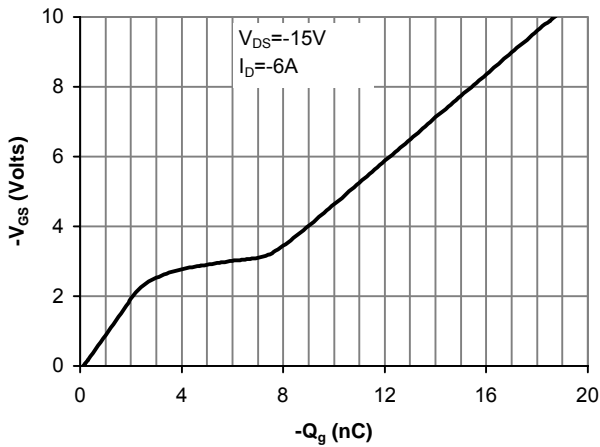

Figure 7: Gate-Charge Characteristics

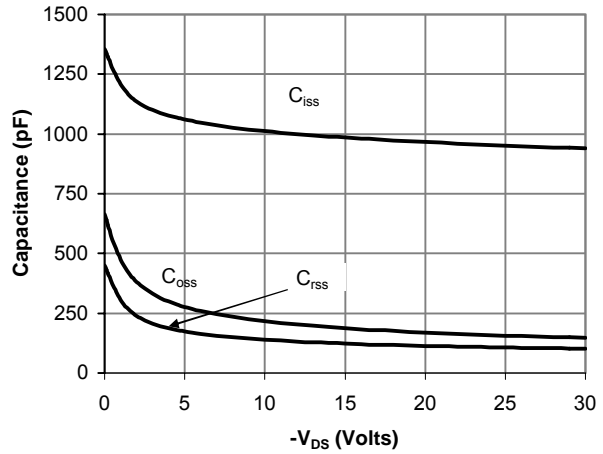

Figure 8: Capacitance Characteristics

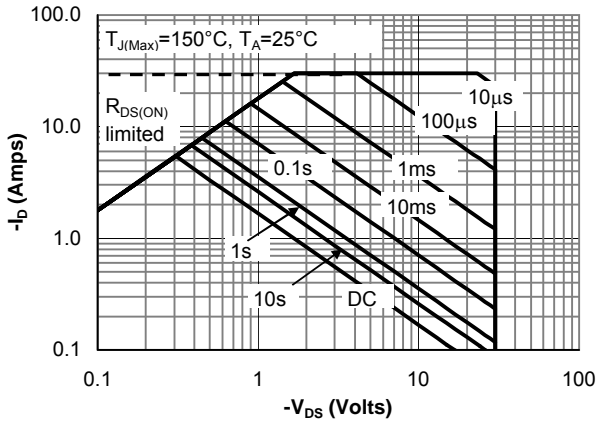

Figure 9: Maximum Forward Biased Safe Operating Area (Note E)

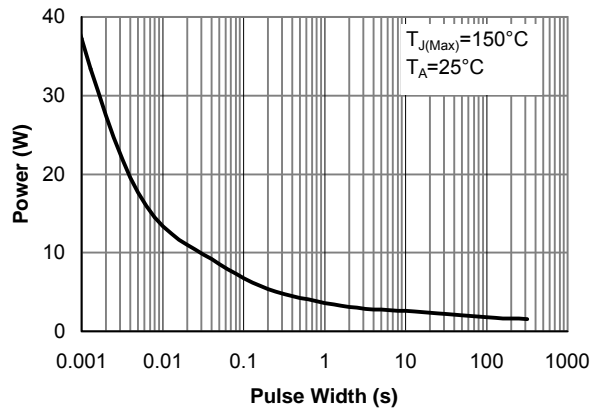

Figure 10: Single Pulse Power Rating Junction-to-Ambient (Note E)

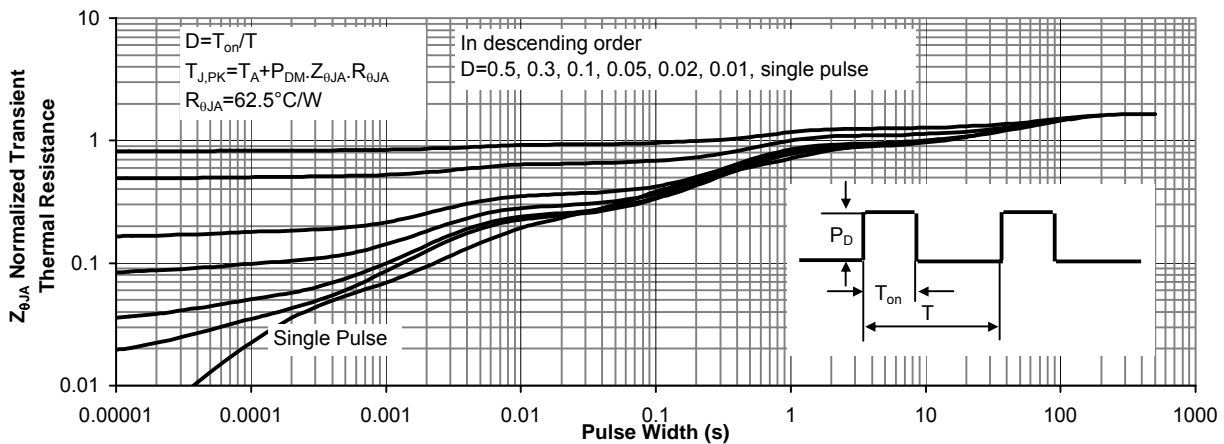
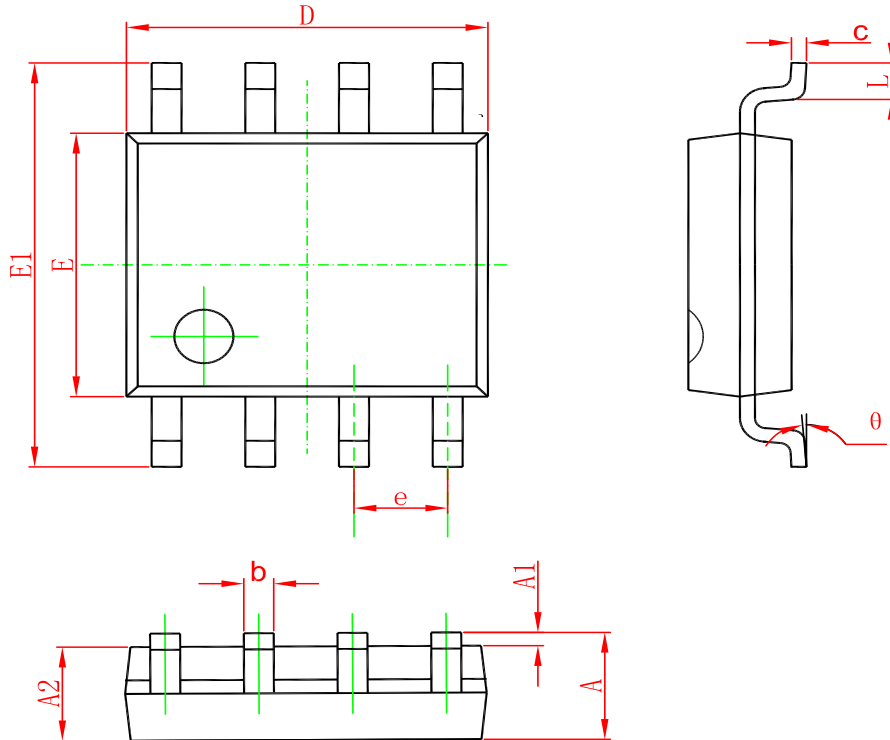

Figure 11: Normalized Maximum Transient Thermal Impedance

PACKAGE OUTLINE DIMENSIONS

SOP-8



Symbol	Dimensions In Millimeters		Dimensions In Inches	
	Min	Max	Min	Max
A	1.350	1.750	0.053	0.069
A1	0.100	0.250	0.004	0.010
A2	1.350	1.550	0.053	0.061
b	0.330	0.510	0.013	0.020
c	0.170	0.250	0.006	0.010
D	4.700	5.100	0.185	0.200
E	3.800	4.000	0.150	0.157
E1	5.800	6.200	0.228	0.244
e	1.270(BSC)		0.050(BSC)	
L	0.400	1.270	0.016	0.050
θ	0°	8°	0°	8°

Marking

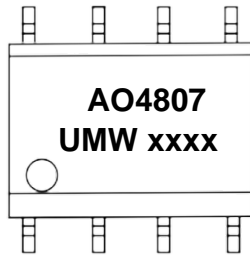

("xxxx"代表年份周期)

Ordering information

Order code	Package	Baseqty	Deliverymode
UMW AO4807	SOP-8	3000	Tape and reel