

# SMD Unshielded Power Inductors - SCD Series

## SCD Series



### Features

- RoHS, Halogen Free and REACH Compliance
- Unshielded power inductor
- Various package size and wide inductance range

### Product Identification

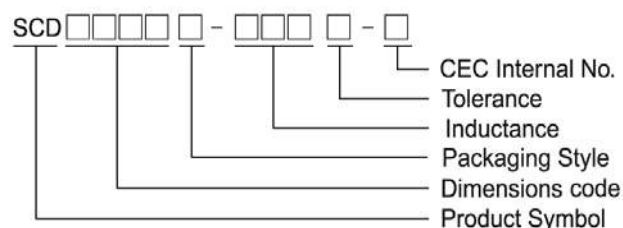

### Applications

- Graphic cards
- DC/DC converters

- Packaging: T : Tape and Reel

### Shape and Dimensions

#### SCD 03015 ~ 1006

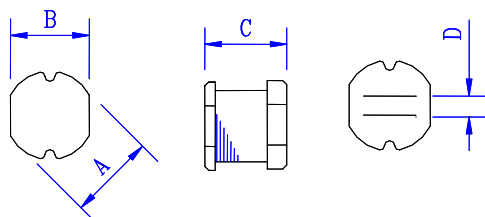

#### SCD 1307

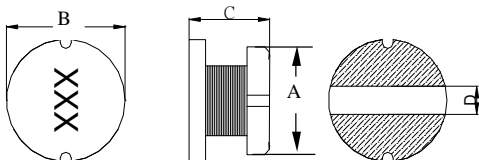

Dimensions in mm

TYPE	A	B	C	D
SCD 03015	3.3 ± 0.3	3.0 ± 0.3	1.5 ± 0.3	1.0 Typ.
SCD 03021	3.3 ± 0.3	3.0 ± 0.3	2.1 ± 0.3	1.0 Typ.
SCD 0403	4.5 ± 0.3	4.0 ± 0.3	3.2 ± 0.3	1.2
SCD 0502	5.8 ± 0.3	5.2 ± 0.3	2.5 ± 0.3	2.0 Typ.
SCD 0503	5.8 ± 0.3	5.2 ± 0.3	3 ± 0.3	2.0 Typ.
SCD 0504	5.8 ± 0.3	5.2 ± 0.3	4.5 ± 0.4	1.3
SCD 0703	7.8 ± 0.3	7.0 ± 0.3	3.5 ± 0.3	2.1
SCD 0705	7.8 ± 0.3	7.0 ± 0.3	5.0 ± 0.3	2.1
SCD 1004	10.0 ± 0.3	9.0 ± 0.3	4.0 ± 0.5	2.1
SCD 1005	10.0 ± 0.4	9.0 ± 0.4	5.4 ± 0.4	2.1
SCD 1006	10.0 ± 0.4	9.0 ± 0.4	6.5 ± 0.4	2.1
SCD 1307	13.0 ± 0.5	13.0 ± 0.5	7.0 ± 0.3	5 Typ.

### Recommended Pattern

#### SCD 1307

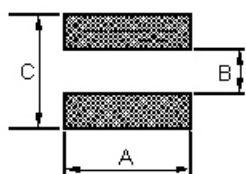

Dimensions in mm

Dim	A	B	C
1307	14	4.5	14

#### SCD03015~SCD1006

Dimensions in mm

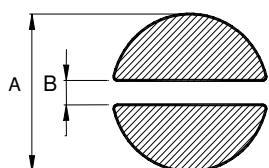

Dim	SCD 03015	SCD 03021	SCD 0403	SCD 0502	SCD 0503	SCD 0504	SCD 0506	SCD 0703	SCD 0705	SCD 0706	SCD 1004	SCD 1005	SCD 1006
A	4.5	4.5	5.5	6.8	6.8	6.8	6.8	8.8	8.8	8.8	11	11	11
B	1.0	1.0	1.2	2.0	2.0	1.3	1.3	2.1	2.1	2.1	2.1	2.1	2.1

PAD LAYOUT

# SMD Unshielded Power Inductors - SCD Series

## Standard Specifications

Stamp	Inductance (μH)	RDC (Ω) Max										
		SCD 03015	SCD 03021	SCD 0403	SCD 0502	SCD 0503	SCD 0504	SCD 0703	SCD 0705	SCD 1004	SCD 1005	SCD 1006
R15	0.15			0.0085								
1R0	1.0		0.07	0.033	0.03	0.03						
1R2	1.2					0.03						
1R4	1.4		0.09	0.038	0.04				0.02			
1R5	1.5					0.03						
1R8	1.8		0.11	0.042	0.05	0.03			0.02			
2R2	2.2	0.10±30%	0.13	0.047	0.06	0.03						
2R7	2.7		0.14	0.052	0.07	0.04			0.02			
3R3	3.3		0.17	0.058	0.08	0.05						
3R9	3.9		0.19	0.076	0.09	0.06			0.03			
4R7	4.7	0.15±30%	0.21	0.094	0.14	0.07			0.04		0.040	
5R6	5.6		0.22	0.101	0.15	0.08			0.04			
6R8	6.8		0.25	0.117	0.16	0.09			0.04		0.037	
8R2	8.2		0.28	0.132	0.17	0.10			0.05			
100	10	0.30±30%	0.32	0.182	0.18	0.12	0.10	0.08	0.07	0.05	0.060	
120	12		0.35	0.210	0.20	0.13	0.12	0.09	0.08	0.06	0.070	
150	15	0.58±30%	0.40	0.235	0.22	0.15	0.14	0.10	0.09	0.07	0.080	
180	18		0.48	0.338	0.25	0.22	0.15	0.11	0.10	0.08	0.090	
220	22	0.71±30%	0.58	0.378	0.35	0.22	0.18	0.13	0.11	0.09	0.100	
270	27		0.65	0.522	0.45	0.26	0.20	0.15	0.12	0.10	0.110	
330	33	1.10±30%	0.80	0.540	0.56	0.33	0.23	0.17	0.13	0.12	0.120	
390	39		0.90	0.587	0.69	0.42	0.32	0.22	0.16	0.15	0.140	
470	47	1.30±30%	1.19	0.844	0.72	0.50	0.37	0.25	0.18	0.17	0.170	
500	50		1.22									
560	56		1.27	0.937	0.84	0.55	0.42	0.28	0.24	0.20	0.190	
680	68	2.20±30%	1.73	1.117	0.90	0.65	0.46	0.33	0.28	0.22	0.220	
750	75		1.90									
820	82		1.99		1.20	0.80	0.60	0.41	0.37	0.30	0.25	
101	100	3.50±30%	2.52	2.000	1.30	0.90	0.70	0.48	0.43	0.34	0.35	
121	120		2.90	1.800	1.38	1.00	0.93	0.54	0.47	0.40	0.40	
151	150		3.36	2.800	1.81	1.30	1.10	0.75	0.64	0.54	0.47	
181	180		5.10	3.200	1.95	1.50	1.38	1.02	0.71	0.62	0.63	
221	220		5.80	4.000	3.00	2.00	1.57	1.20	0.96	0.72	0.73	
271	270		7.80		3.20	2.50	1.85	1.31	1.11	0.95	0.97	
331	330			5.850	3.82	3.20	2.00	1.50	1.26	1.10	1.15	
391	390				4.68	3.50	2.60		1.77	1.24	1.30	
471	470				5.10	4.20	3.00		1.96	1.53	1.48	
561	560				8.50	4.50	4.19			1.90	1.90	
681	680				10.0	6.50	4.44				2.25	
821	820				12.0	7.50	5.12				2.55	
102	1000				18.0	8.00	10.00		2.80			
602	6000											14
822	8200											50

**Note: When ordering, please specify tolerance code. Tolerance: K=±10% , M=±20%**

- Operating temperature range - 40°C ~ 105°C(Including self - temperature rise)
- Isat for Inductance drop 10% from its value with current
- Measure Equipment :
  - Test Freq L : SCD03015: (1MHz/1V), SCD1005/1006: 1.0 ~ 8.2μH(7.96MHz/1V), 10 ~ 82μH (2.52MHz/1V), 100 ~ 1000μH (1kHz/1V)
  - SCD03021/0403/0502/ 0503: 0.15 ~ 8.2μH(7.96MHz/1V), 10 ~ 82μH (2.52MHz/1V), 100 ~ 1000μH (1kHz/1V).
  - SCD0504/0703/0705/1004: 1.0 ~ 8.2μH(7.96MHz/1V), 10 ~ 82μH (2.52MHz/1V), 100 ~ 1000μH (1kHz/1V).
- L : Agilent/ E4980 or HP4284A (under 1MHz), HP4285A (over 1MHz)
- RDC : CHEN HWA 502
- Isat : HP4284+42841A or WK3260B+WK3265B

# SMD Unshielded Power Inductors - SCD Series

## Standard Specifications

Stamp	Inductance ( $\mu$ H)	Isat (A) Max										
		SCD 03015	SCD 03021	SCD 0403	SCD 0502	SCD 0503	SCD 0504	SCD 0703	SCD 0705	SCD 1004	SCD 1005	SCD 1006
R15	0.15			7.5								
1R0	1.0		2.080	3.80	4.50	4.50						
1R2	1.2					4.20						
1R4	1.4		1.860	3.30	4.00				3.70			
1R5	1.5					4.10						
1R8	1.8		1.800	2.91	3.30	3.70			3.70			
2R2	2.2	0.79	1.390	2.60	2.94	3.50						
2R7	2.7		1.320	2.43	2.50	3.20			3.70			
3R3	3.3		1.250	2.15	2.35	2.80						
3R9	3.9		1.200	1.98	2.20	2.60			3.70			
4R7	4.7	0.65	1.130	1.70	2.00	2.50			3.50		2.60	
5R6	5.6		0.910	1.60	1.80	2.40			3.30			
6R8	6.8		0.850	1.41	1.70	2.20			3.10		4.33	
8R2	8.2		0.820	1.26	1.40	2.00			2.70			
100	10	0.45	0.740	1.15	1.20	1.80	1.44	1.44	2.30	2.38	2.60	
120	12		0.640	1.05	1.18	1.75	1.40	1.39	2.00	2.13	2.45	
150	15	0.30	0.600	0.92	1.15	1.70	1.30	1.24	1.80	1.87	2.27	
180	18		0.540	0.84	1.10	1.60	1.23	1.12	1.60	1.73	2.15	
220	22	0.25	0.500	0.76	1.00	1.50	1.11	1.07	1.50	1.60	1.95	
270	27		0.430	0.71	0.86	1.40	0.97	0.94	1.30	1.44	1.76	
330	33	0.20	0.400	0.64	0.76	1.10	0.88	0.85	1.20	1.26	1.50	
390	39		0.370	0.59	0.75	1.00	0.80	0.74	1.10	1.20	1.37	
470	47	0.17	0.360	0.54	0.73	0.90	0.72	0.68	1.10	1.10	1.28	
500	50		0.330									
560	56		0.310	0.50	0.55	0.85	0.68	0.64	0.94	1.01	1.17	
680	68	0.13	0.300	0.46	0.52	0.80	0.61	0.59	0.85	0.91	1.11	
750	75		0.290									
820	82		0.280		0.50	0.65	0.58	0.54	0.78	0.85	1.00	
101	100	0.10	0.250	0.40	0.40	0.60	0.52	0.51	0.72	0.74	0.97	
121	120		0.200	0.38	0.36	0.58	0.48	0.49	0.66	0.69	0.89	
151	150		0.190	0.30	0.30	0.43	0.40	0.40	0.58	0.61	0.78	
181	180		0.170	0.25	0.26	0.41	0.38	0.36	0.51	0.56	0.72	
221	220		0.160	0.15	0.25	0.38	0.35	0.31	0.49	0.53	0.66	
271	270		0.140		0.21	0.35	0.29	0.29	0.42	0.45	0.57	
331	330			0.21	0.18	0.28	0.28	0.28	0.40	0.42	0.52	
391	390				0.16	0.26	0.26		0.36	0.38	0.48	
471	470				0.15	0.20	0.12		0.34	0.35	0.42	
561	560				0.14	0.19	0.10			0.32	0.33	
681	680				0.13	0.18	0.08				0.28	
821	820				0.07	0.15	0.05				0.24	
102	1000				0.05	0.13	0.03		0.19			
602	6000											0.27
822	8200											0.20

### Tolerance Of Inductors

- SCD03015 2.2 ~ 100 $\mu$ H  $\pm$  20%
- SCD03021 1.0 ~ 270 $\mu$ H  $\pm$  20%
- SCD0403 0.15 ~ 27 $\mu$ H  $\pm$  20% 33 ~ 100 $\mu$ H  $\pm$  10%
- SCD0502 1.0 ~ 27 $\mu$ H  $\pm$  20% 33 ~ 1000 $\mu$ H  $\pm$  10%
- SCD0503 1.0 ~ 27 $\mu$ H  $\pm$  20% 33 ~ 1000 $\mu$ H  $\pm$  10%
- SCD0504 1.0~27 $\mu$ H $\pm$ 20% 33~47 $\mu$ H  $\pm$ 15% 56~1000 $\mu$ H $\pm$ 10%
- SCD0703 10 ~ 27 $\mu$ H  $\pm$  20% 33 ~ 330 $\mu$ H  $\pm$ 10%
- SCD0705 1.4 ~ 27 $\mu$ H  $\pm$  20% 33 ~ 470 $\mu$ H  $\pm$ 10%
- SCD1004 10 ~ 27 $\mu$ H  $\pm$  20% 33 ~ 560 $\mu$ H  $\pm$ 10%
- SCD1005 4.7 ~ 27 $\mu$ H  $\pm$  20% 33 ~ 820 $\mu$ H  $\pm$ 10%
- SCD1006 6000 $\mu$ H ~8200 $\mu$ H $\pm$ 20%

Tolerance: K =  $\pm$ 10% , M =  $\pm$ 20%

# SMD Shielded Power Inductors – SCD Series

## Electrical Characteristics

Part Number	Inductance ( $\mu$ H)	Tolerance ( $\pm$ %)	Q Ref	Q Frequency (MHz)	SRF (MHz) Typ.	RDC (m $\Omega$ ) Typ.	I <sub>rms</sub> (A) Max	I <sub>sat</sub> (A) Typ.
SCD1307T-1R5□-N	1.5	20	20	7.96 / 0.1V	65	5.0	9.50	20.0
SCD1307T-2R2□-N	2.2	20	22	7.96 / 0.1V	50	6.0	9.00	18.0
SCD1307T-2R7□-N	2.7	20	24	7.96 / 0.1V	40	8.0	8.20	16.0
SCD1307T-3R3□-N	3.3	20	26	7.96 / 0.1V	38	8.7	7.50	15.0
SCD1307T-4R7□-N	4.7	20	25	7.96 / 0.1V	36	10	7.00	13.0
SCD1307T-5R6□-N	5.6	20	24	7.96 / 0.1V	28	15	6.50	11.0
SCD1307T-6R8□-N	6.8	20	24	7.96 / 0.1V	26	17	6.00	10.5
SCD1307T-8R2□-N	8.2	20	24	7.96 / 0.1V	24	19	5.80	9.8
SCD1307T-100□-N	10	20	22	2.52 / 0.1V	22	21	5.60	9.2
SCD1307T-120□-N	12	20	25	2.52 / 0.1V	20	30	4.80	8.0
SCD1307T-150□-N	15	20	28	2.52 / 0.1V	17	34	4.50	7.5
SCD1307T-180□-N	18	20	28	2.52 / 0.1V	16	36	4.20	7.0
SCD1307T-220□-N	22	20	40	2.52 / 0.1V	15	47	3.60	6.5
SCD1307T-270□-N	27	20	35	2.52 / 0.1V	11	60	3.30	5.5
SCD1307T-330□-N	33	20 / 10	35	2.52 / 0.1V	10	65	3.10	5.0
SCD1307T-390□-N	39	20 / 10	28	2.52 / 0.1V	9.0	75	2.90	4.6
SCD1307T-470□-N	47	20 / 10	24	2.52 / 0.1V	7.5	82	2.70	4.2
SCD1307T-560□-N	56	20 / 10	22	2.52 / 0.1V	7.2	95	2.50	3.8
SCD1307T-680□-N	68	20 / 10	24	2.52 / 0.1V	7.0	120	2.30	3.5
SCD1307T-820□-N	82	20 / 10	18	2.52 / 0.1V	6.0	140	2.10	3.2
SCD1307T-101□-N	100	20 / 10	25	0.796 / 0.1V	5.8	180	1.90	3.0
SCD1307T-121□-N	120	20 / 10	20	0.796 / 0.1V	5.5	210	1.80	2.8
SCD1307T-151□-N	150	20 / 10	20	0.796 / 0.1V	4.5	250	1.60	2.6
SCD1307T-181□-N	180	20 / 10	18	0.796 / 0.1V	4.0	280	1.50	2.3
SCD1307T-221□-N	220	20 / 10	15	0.796 / 0.1V	3.8	360	1.30	2.1
SCD1307T-271□-N	270	20 / 10	15	0.796 / 0.1V	3.5	410	1.20	1.8
SCD1307T-331□-N	330	20 / 10	15	0.796 / 0.1V	3.2	520	1.10	1.6
SCD1307T-391□-N	390	20 / 10	12	0.796 / 0.1V	2.5	600	1.00	1.5
SCD1307T-471□-N	470	20 / 10	12	0.796 / 0.1V	2.2	720	0.90	1.4
SCD1307T-561□-N	560	20 / 10	10	0.796 / 0.1V	2.0	880	0.85	1.3
SCD1307T-681□-N	680	20 / 10	10	0.796 / 0.1V	1.6	1000	0.80	1.2
SCD1307T-821□-N	820	20 / 10	10	0.796 / 0.1V	1.5	1300	0.75	1.1
SCD1307T-102□-N	1000	20 / 10	10	0.252 / 0.1V	1.4	1600	0.65	1.0

**Note: When ordering, please specify tolerance code. Tolerance: K=±10% , M=±20%**

- Operating temperature range - 40°C ~ 105°C(Including self - temperature rise)
- I<sub>sat</sub> for Inductance drop 10% from its value with current
- I<sub>rms</sub> for a 40°C temperature rise from 25°C ambient with current
- Measure Equipment :
  - L : Agilent/ E4980 or HP4284A, 100kHz 0.1V
  - Q : Agilent/ E4980 or HP4284A (under 1MHz), HP4285A (over 1MHz)
  - SRF : HP4286A
  - RDC : CHEN HWA 502
  - I<sub>sat</sub> : HP4284+42841A or WK3260B+WK3265B

# SMD Unshielded Power Inductors - SCD Series

Test Instruments : HP4294A Impedance / Material Analyzer

## SCD0403

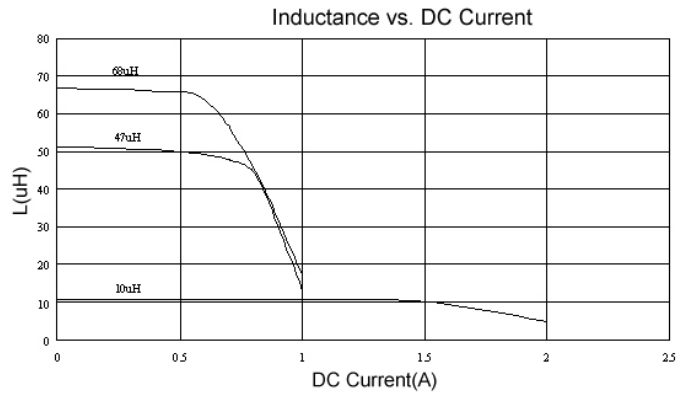
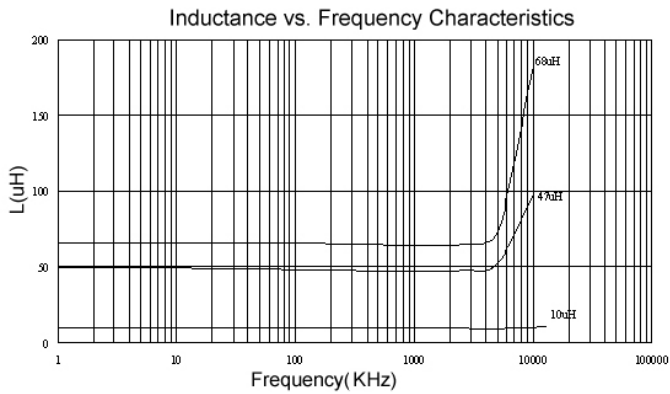

## SCD0504

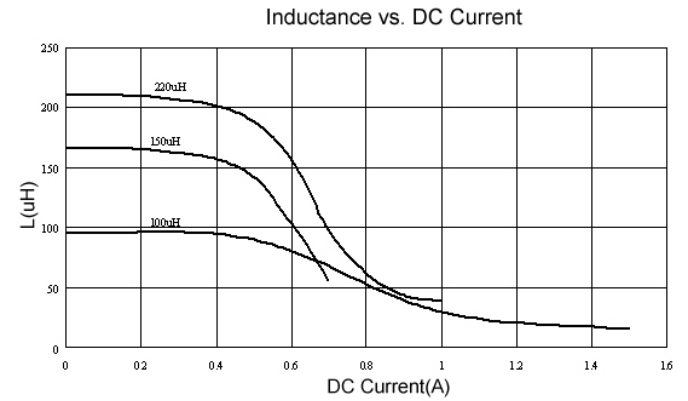
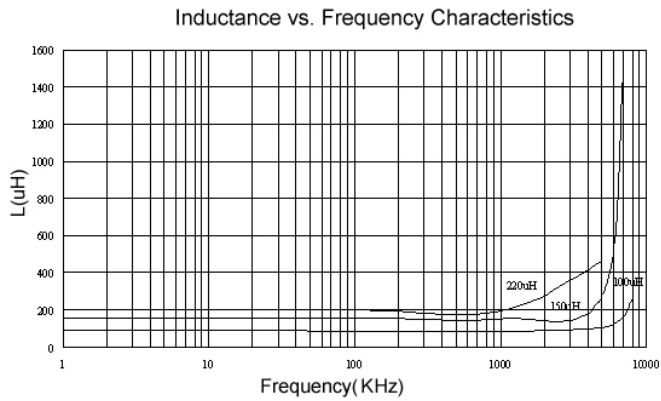

## SCD0703

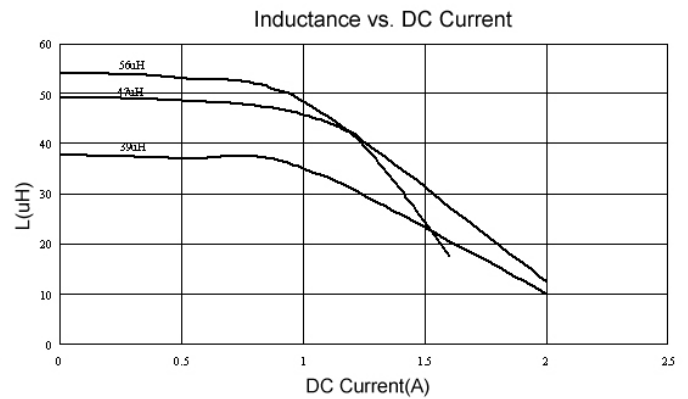
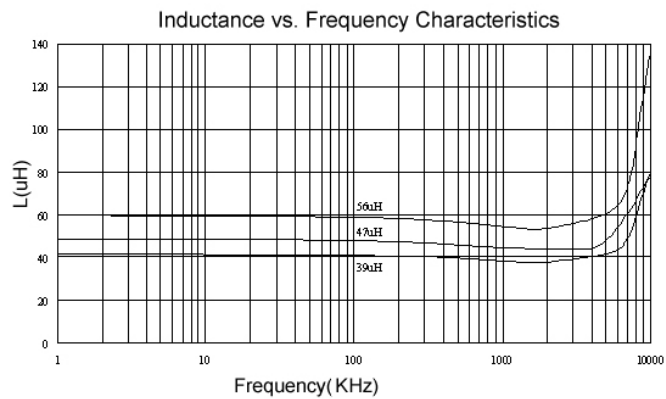

# SMD Unshielded Power Inductors - SCD Series

Test Instruments : HP4294A Impedance / Material Analyzer

## SCD0705

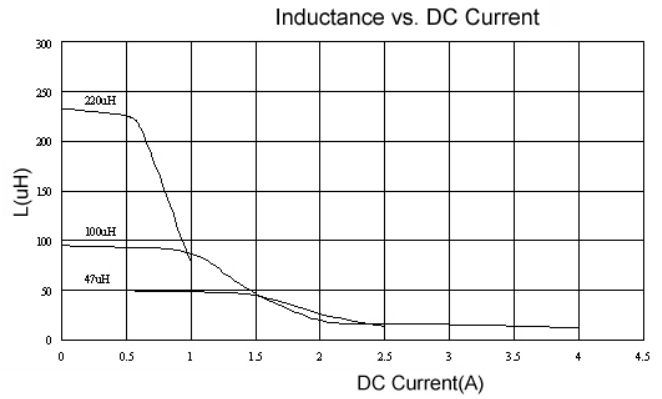
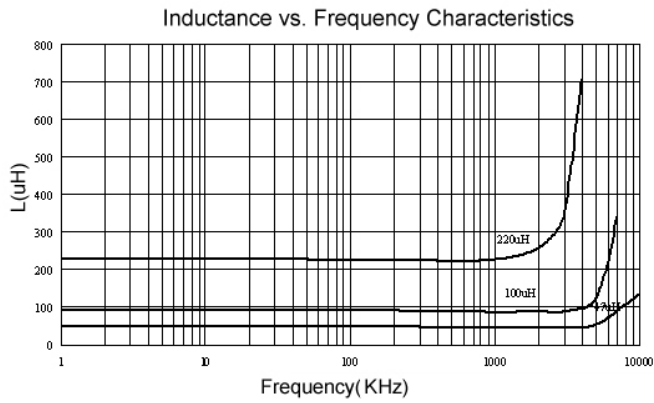

## SCD1004

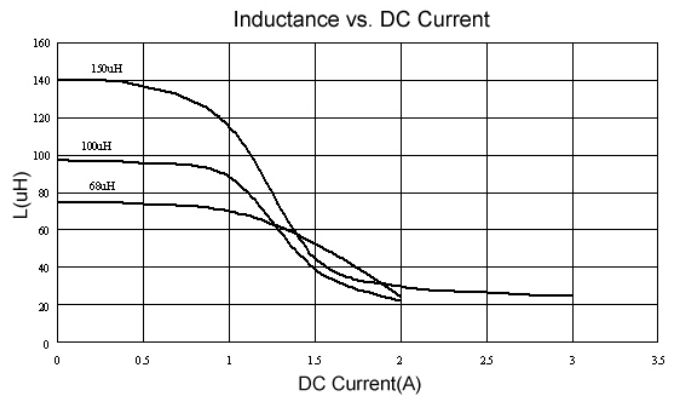
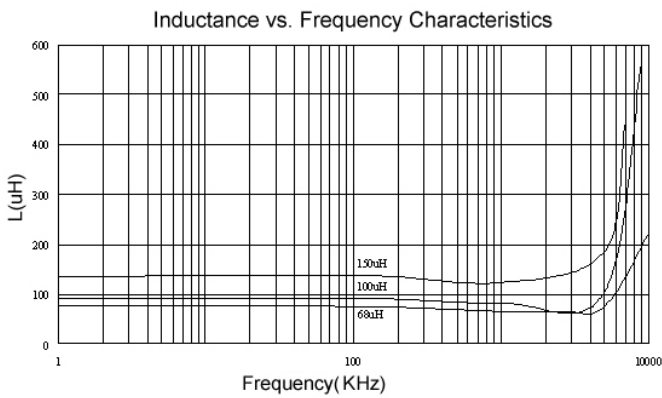

## SCD1005

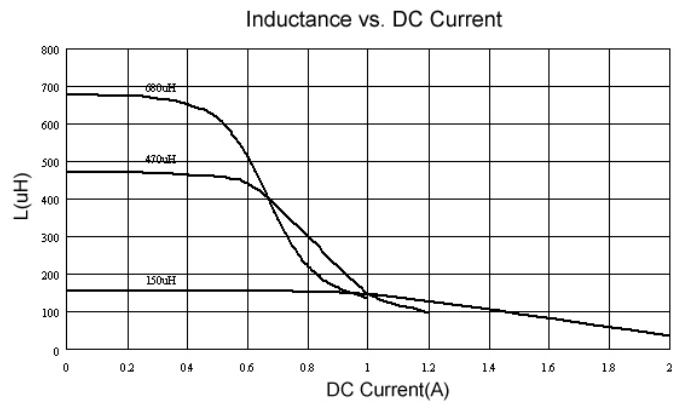
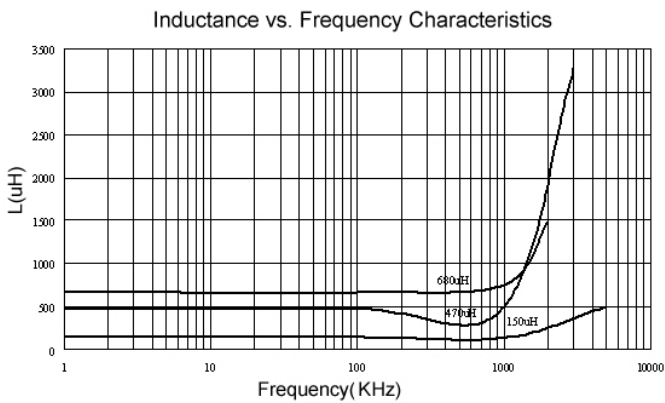

# SMD Unshielded Power Inductors - SCD Series

## Packaging Specifications

Tape Dimensions

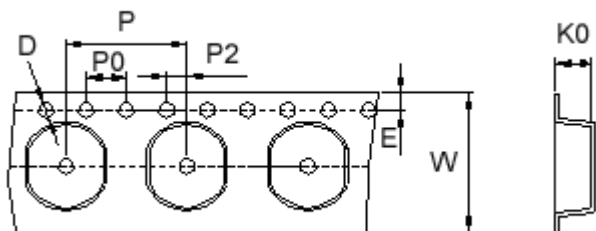

Tape Material

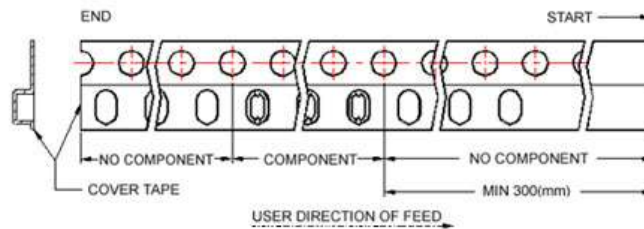

Reel Dimensions

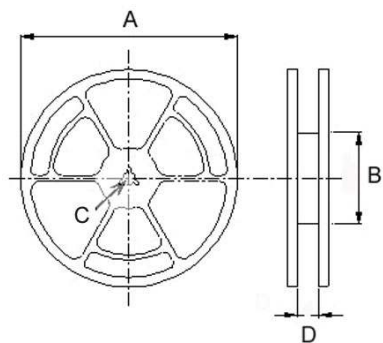

Dimensions in mm

TYPE	Tape Dimensions							Reel Dimensions				Quantity PCS / REEL
	K0	D	E	W	P	P0	P2	A	B	C	D	
SCD03015	1.80	1.55	1.75	12	8	4	2	330	100	13	13.4	3000
SCD03021	2.50	1.55	1.75	12	8	4	2	330	100	13	13.4	3000
SCD0403	3.55	1.55	1.75	12	8	4	2	330	100	13	13.4	2000
SCD0502	3.30	1.50	1.75	16	8	4	2	330	100	13	17.4	2000
SCD0503	3.30	1.50	1.75	16	8	4	2	330	100	13	17.4	2000
SCD0504	4.8	1.55	1.75	16	8	4	2	330	100	13	17.4	1500
SCD0703	3.8	1.55	1.75	16	12	4	2	330	100	13	17.4	1000
SCD0705	5.2	1.55	1.75	16	12	4	2	330	100	13	17.4	700
SCD1004	4.5	1.55	1.75	24	12	4	2	330	100	13	24.4	700
SCD1005	5.8	1.55	1.75	24	12	4	2	330	100	13	24.4	700
SCD1006	7.0	1.55	1.75	24	12	4	2	330	100	13	24.4	500
SCD1307	7.4	1.55	1.75	24	16	4	2	330	100	13	24.4	500