

Electronic timer CT-MFE

Multifunctional with 1 c/o (SPDT) contact

The CT-MFE is a multifunctional electronic time relay. It is from the CT-E range.

The CT-E range is the economic range of ABB's time relays and offers a cost effective price-performance ratio for OEM users. This is achieved by simplified functionality and results in the simplest of setup procedures. The CT-E range is ideally suited for repeat applications.



Characteristics

- One device includes 8 times ranges, from 0.05 s to 100 h
- Rated control supply voltage range from 24 to 240 V AC/DC
- Multifunction timer with 6 timing functions: ON-delay, OFF-delay, impulse-ON, flasher starting with ON, flasher starting with OFF, pulse former
- Timing can be started via an external, voltage-related control input
- 1 c/o (SPDT) contact
- 22.5 mm (0.89 in) width
- 2 LEDs for the indication of operational states

Approvals

- UL LISTED UL 508, CAN/CSA C22.2 No. 14
- GL
- GOST
- CB CB scheme
- CCC
- RMRS

Marks

- CE CE
- C-Tick

Order data

Type	Rated control supply voltage	Time range	Order code
CT-MFE	24-240 V AC/DC	0.05 s - 100 h	1SVR 550 029 R8100

Functions

Operating controls

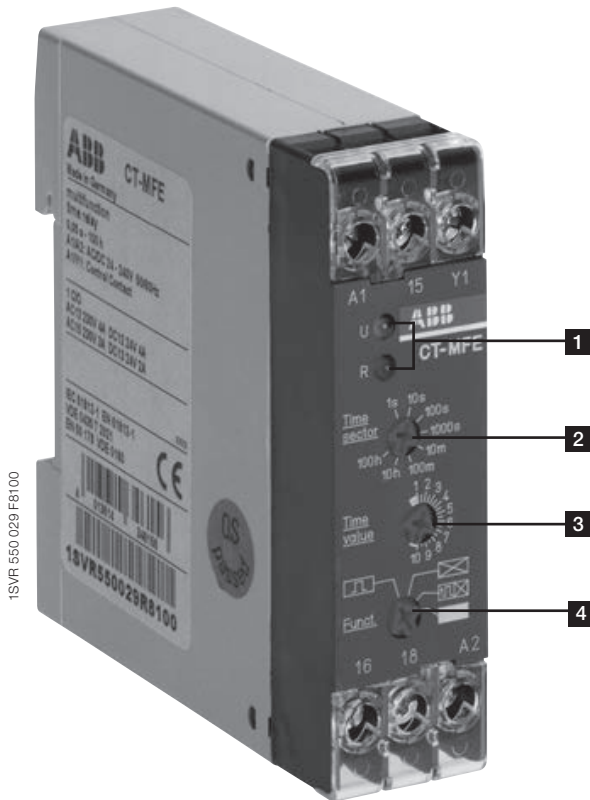

1 Indication of operational states

U: green LED – Control supply voltage applied

R: red LED - Output relay energized

2 Rotary switch for the preselection of the time range

3 Rotary switch for the fine adjustment of the time delay

4 Rotary switch for the selection of the timing function

ON-Delay: , triggering via control supply voltage

OFF-Delay: , triggering via control input A1-Y1

Pulse former: , triggering via control input A1-Y1

Impulse-ON:  and control input A1-Y1 jumpered

Flasher starting with ON:  and control input A1-Y1 open

Flasher starting with OFF:  and control input A1-Y1 jumpered

Application

Their conception makes the CT-E range timers ideal for repeat applications. Multifunction timers are ideally suited for service and maintenance applications, because one device can replace a number of time relays with different functions, voltage and time ranges. This reduces inventory and saves money.

Operating mode

The CT-MFE with 1 c/o (SPDT) contact provides 6 timing functions. The function is rotary switch selectable on the front of the unit. Each function is indicated by an international function symbol. One of 8 time delay ranges, from 0.05 s to 100 h, can be selected with another rotary switch. The fine adjustment of the time delay is also made via a rotary switch.

Function diagrams

☒ ON-delay (Delay on make)

Timing begins when control supply voltage is applied. When the selected time delay is complete, the output relay energizes. If control supply voltage is interrupted, the output relay de-energizes and the time delay is reset. Interrupting control supply voltage before the time delay is complete, resets the time delay. The output relay does not energize.

Control input A1-Y1 is disabled when this function is selected.

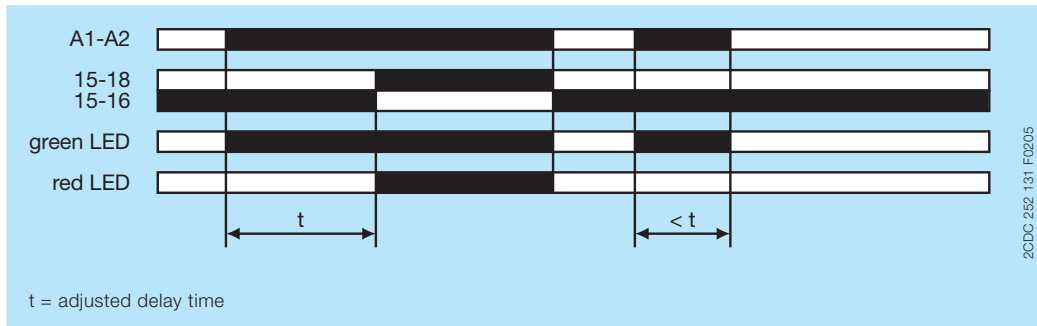

■ OFF-delay with auxiliary voltage (Delay on break)

This function requires continuous control supply voltage for timing. Timing is controlled by control input A1-Y1. If the control input is closed, the output relay energizes. If control input A1-Y1 is opened, the selected time delay starts. When the time delay is complete, the output relay de-energizes. If control input A1-Y1 is closed before the time delay is complete, the time delay is reset. Timing starts again when the control input re-opens.



1┐☒ Impulse-ON (Interval)

The output relay energizes immediately when control supply voltage is applied and de-energizes after the selected time delay time is complete. If control supply voltage is interrupted before the time delay is complete, the output relay de-energizes and the time delay is reset.

Control input A1-Y1 has to be jumpered, when this timing function is selected.

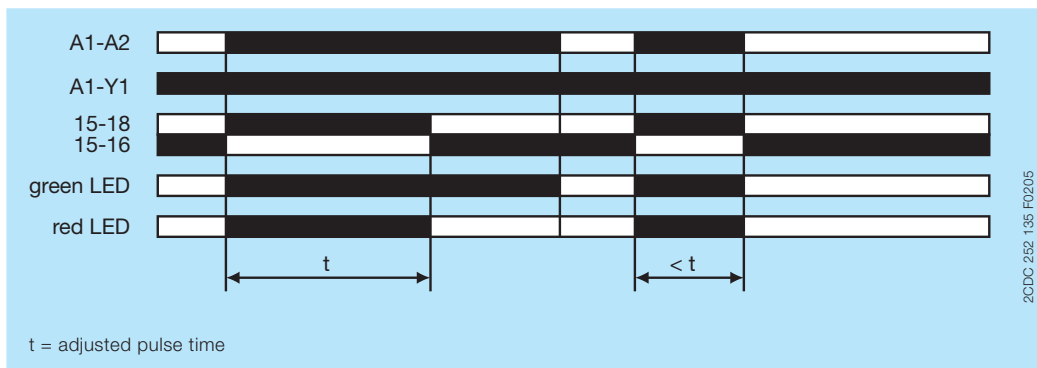

1 Pulse former (Single shot)

Closing the control input A1-Y1, with control supply voltage applied, energizes the output relay for the selected ON time. Operating the control input during timing has no effect. When the ON time is complete, the output relay de-energizes. Timing can be restarted by re-closing control input A1-Y1. If control supply voltage is interrupted during timing, the output relay de-energizes and the ON time is reset.

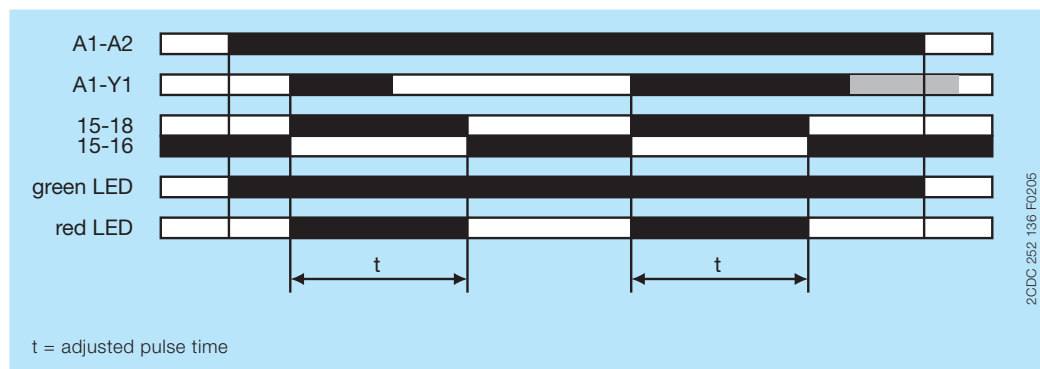

Flasher with symmetrical ON & OFF times, starting with the ON time (Recycling equal times, ON first)

Applying control supply voltage starts timing with symmetrical ON & OFF times. The cycle starts with an ON time first. If control supply voltage is interrupted, the output relay de-energizes and the time delay is reset.

Control input A1-Y1 has to be open, when this timing function is selected.

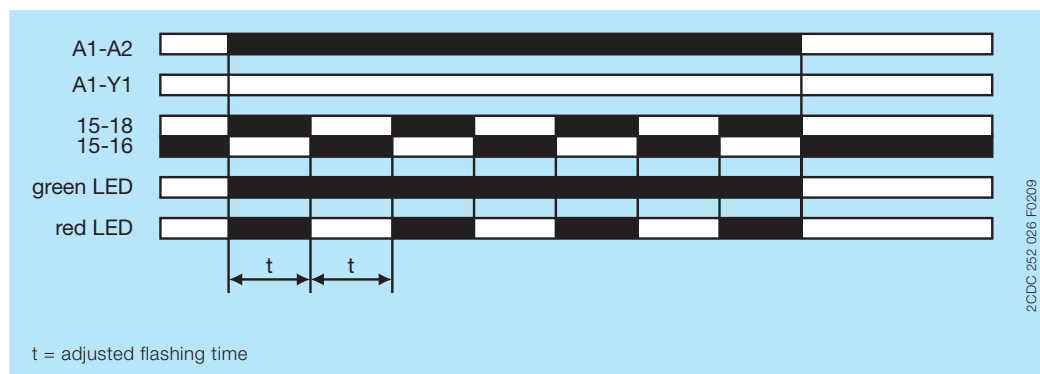

Flasher with symmetrical ON & OFF times, starting with the OFF time (Recycling equal times, OFF first)

Applying control supply voltage starts timing with symmetrical ON & OFF times. The cycle starts with an OFF time first. If control supply voltage is interrupted, the output relay de-energizes and the time delay is reset.

Control input A1-Y1 has to be jumpered, when this timing function is selected.

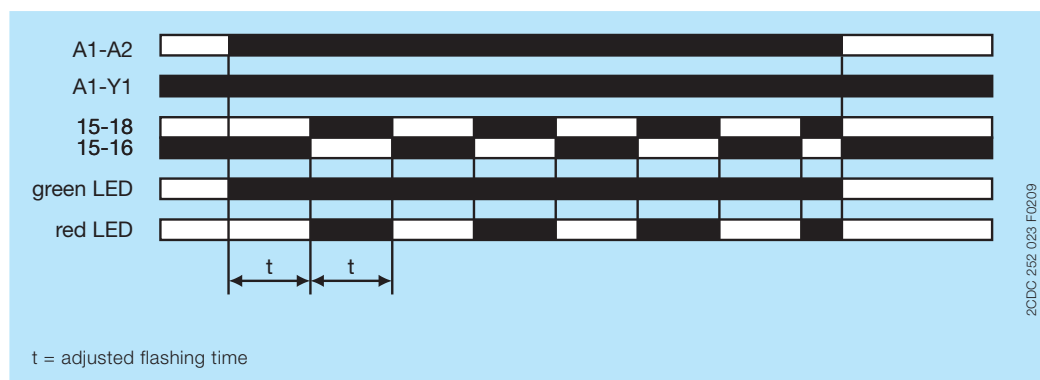

Electrical connection

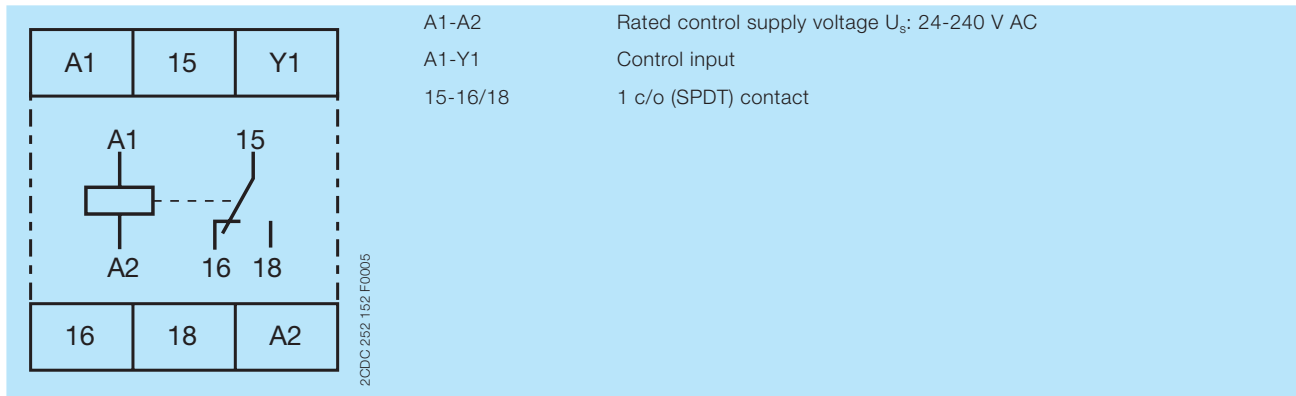

Connection diagram

Technical data

Data at $T_a = 25\text{ °C}$ and rated values, unless otherwise indicated

Input circuits

Supply circuit		
Rated control supply voltage U_s	A1-A2	24-240 V AC/DC
Rated control supply voltage U_s tolerance		-15...+10 %
Typical current / power consumption	24-240 V AC/DC	approx. 1.0-2.0 VA/W
Rated frequency		DC or 50/60 Hz

Control circuit		
Control input, control function	A1-Y1	start timing external
Kind of triggering		voltage-related
Parallel load		yes
Polarized		no
Control voltage potential		rated control supply voltage
Minimum control pulse length		20 ms

Timing circuit	
Time ranges	0.05-1 s, 0.5-10 s, 5-100 s, 50-1000 s, 0.5-10 min, 5-100 min, 0.5-10 h, 5-100 h
Recovery time	< 50 ms
Repeat accuracy (constant parameters)	$\Delta t < 1\%$
Accuracy within the rated control supply voltage tolerance	$\Delta t < 0.5\% / V$
Accuracy within the temperature range	$\Delta t < 0.06\% / \text{°C}$

User interface

Indication of operational states		
Control supply voltage	U: green LED	: control supply voltage applied
Relay status	R: red LED	: output relay energized

Output circuit

Kind of output	15-16/18	relay, 1 c/o (SPDT) contact
Contact material		AgCdO
Rated operational voltage U_e (IEC/EN 60947-1)		250 V
Maximum switching voltage		250 V AC, 250 V DC
Rated operational current I_e (IEC/EN 60947-5-1)	AC12 (resistive) at 230 V	4 A
	AC15 (inductive) at 230 V	3 A
	DC12 (resistive) at 24 V	4 A
	DC13 (inductive) at 24 V	2 A
AC rating (UL 508)	Utilization category (Control Circuit Rating Code)	B 300
	max. rated operational voltage	300 V AC
	Maximum continuous thermal current at B300	5 A
	max. making/breaking apparent power at B300	3600 VA / 360 VA
Mechanical lifetime		30×10^6 switching cycles
Electrical lifetime	AC12, 230 V, 4 A	0.1×10^6 switching cycles
Maximum fuse rating to achieve short-circuit protection	n/c contact	10 A fast
	n/o contact	10 A fast

General data

MTBF		on request
Duty time		100 %
Dimensions (W x H x D)	product dimensions	22.5 x 78.0 x 78.5 mm (0.89 x 3.07 x 3.09 in)
	packaging dimensions	84.2 x 83.1 x 24.6 mm (3.31 x 3.27 x 0.97 in)
Weight	net weight	0.070 kg (0.154 lb)
	gross weight	0.086 kg (0.190 lb)
Mounting		DIN rail (IEC/EN 60715), snap-on mounting without any tool
Mounting position		any
Degree of protection	housing	IP50
	terminals	IP20

Electrical connection

Wire size	fine-strand with wire end ferrule	$2 \times 0.75\text{-}1.5 \text{ mm}^2$ (2 x 18-16 AWG)
	fine-strand without wire end ferrule	$2 \times 1\text{-}1.5 \text{ mm}^2$ (2 x 18-16 AWG)
	rigid	$2 \times 0.75\text{-}1.5 \text{ mm}^2$ (2 x 18-16 AWG)
Stripping length		10 mm (0.39 in)
Tightening torque		0.6-0.8 Nm (5.31-7.08 lb.in)

Environmental data

Ambient temperature ranges	operation	-20...+60 °C
	storage	-40...+85 °C
Operational reliability	IEC/EN 60068-2-6	6 g
Mechanical resistance	IEC/EN 60068-2-6	10 g
Damp heat, cyclic	IEC/EN 60068-2-30	24 h cycle, 55 °C, 93 % rel., 96 h

Isolation data

Rated insulation voltage between supply, control and output circuit (IEC/EN 60947-1)	Control supply voltage up to 240 V: 300 V
	Control supply voltage up to 440 V: 500 V
Rated impulse withstand voltage U_{imp} between all isolated circuits (IEC/EN 60664)	4 kV / 1.2-50 μ s
Test voltage between all isolated circuits (routine test)	2.5 kV, 50 Hz, 1 min.
Pollution degree (IEC/EN 60664, IEC/EN 60255-5)	III/C
Overvoltage category (IEC/EN 60664, IEC/EN 60255-5)	III/C

Standards

Product standard	IEC 61812-1, EN 61812-1 +A11
Low Voltage Directive	2006/95/EC
EMC directive	2004/108/EC

Electromagnetic compatibility

Interference immunity to	IEC/EN 61000-6-2	
electrostatic discharge	IEC/EN 61000-4-2	Level 3 (6 kV / 8 kV)
radiated, radio-frequency, electromagnetic field	IEC/EN 61000-4-3	Level 3 (10 V/m)
electrical fast transient / burst	IEC/EN 61000-4-4	Level 3 (2 kV / 5 kHz)
surge	IEC/EN 61000-4-5	Level 4 (2 kV L-L)
conducted disturbances, induced by radio-frequency fields	IEC/EN 61000-4-6	Level 3 (10 V)
Interference emission	IEC/EN 61000-6-4	

Technical diagrams

Load limit curves

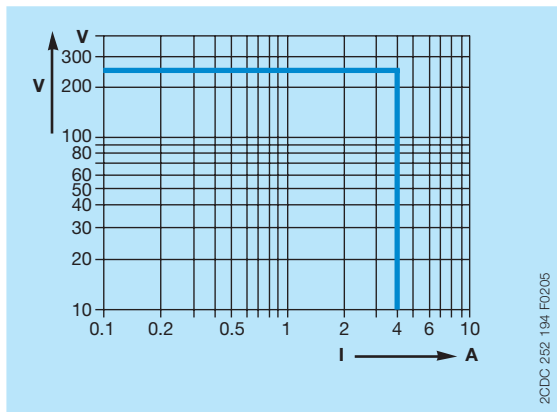

AC load (resistive)

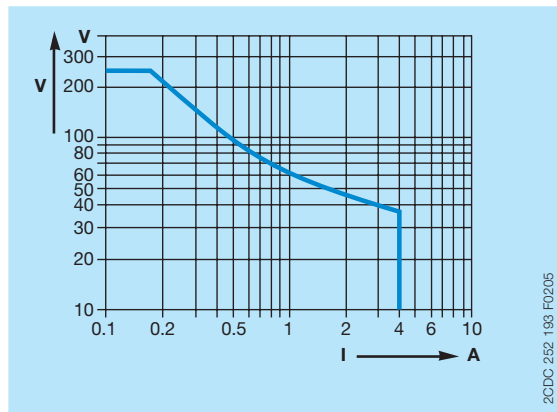

DC load (resistive)

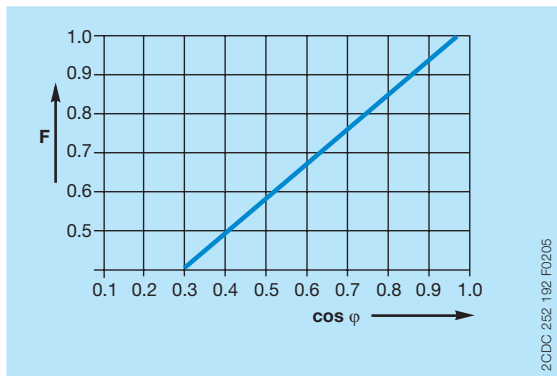

Derating factor F for inductive AC load

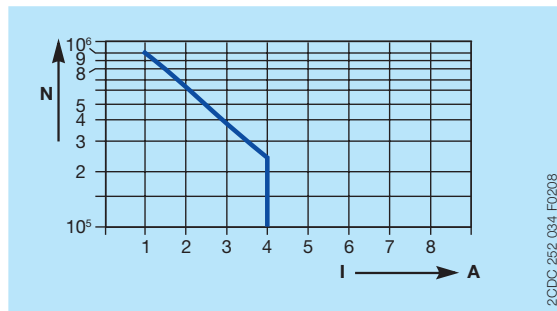

Contact lifetime /switching cycles N
220 V 50 Hz AC1, 360 cycles/h

Dimensions

in **mm** and *inches*

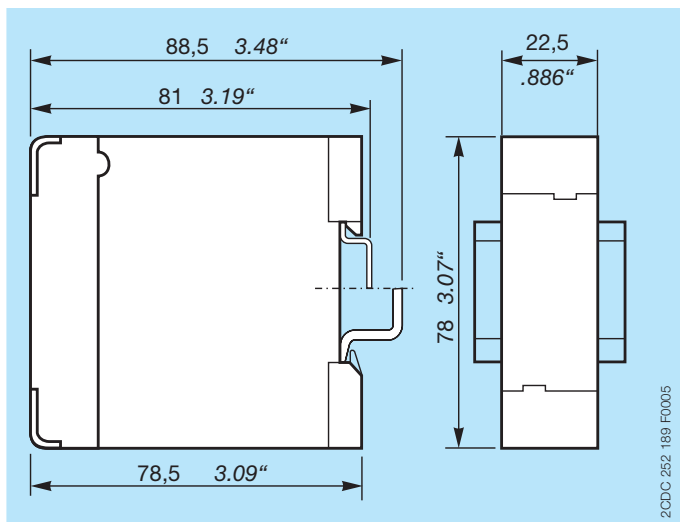

Further documentation

Document title	Document type	Document number
Electronic products and relays	Technical catalogue	2CDC 110 004 C02xx
CT-MFE	Instruction manual	1SVC 557 021 M1000

You can find the documentation on the internet at www.abb.com/lowvoltage -> Control Products -> Electronic Relays and Controls -> Time Relays.

CAD system files

You can find the CAD files for CAD systems at <http://abb-control-products.partcommunity.com/PARTcommunity/Portal/abb-control-products> -> Low Voltage Products & Systems -> Control Products -> Electronic Relays and Controls -> Time Relays -> CT-E - Time Relays.

Contact us

ABB STOTZ-KONTAKT GmbH

P. O. Box 10 16 80
69006 Heidelberg, Germany
Phone: +49 (0) 6221 7 01-0
Fax: +49 (0) 6221 7 01-13 25
E-mail: info.desto@de.abb.com

You can find the address of your
local sales organisation on the
ABB home page
<http://www.abb.com/contacts>
-> Low Voltage Products and Systems

Note:

We reserve the right to make technical changes or modify the contents of this document without prior notice. With regard to purchase orders, the agreed particulars shall prevail. ABB AG does not accept any responsibility whatsoever for potential errors or possible lack of information in this document.

We reserve all rights in this document and in the subject matter and illustrations contained therein. Any reproduction, disclosure to third parties or utilization of its contents – in whole or in parts – is forbidden without prior written consent of ABB AG.

Copyright© 2013 ABB
All rights reserved