

1PS66SB82; 1PS88SB82

15 V, 30 mA low C_d Schottky barrier diodes

Rev. 04 — 13 January 2010

Product data sheet

1. Product profile

1.1 General description

Epitaxial low capacitance Schottky barrier diodes encapsulated in very small SMD plastic packages.

Table 1. Product overview

Type number	Package		Configuration
	Nexperia	JEITA	
1PS66SB82	SOT666	-	triple isolated diode
1PS88SB82	SOT363	SC-88	triple isolated diode

1.2 Features

- Low diode capacitance
- Low forward voltage
- Very small SMD plastic packages

1.3 Applications

- Digital applications:
 - ◆ Ultra high-speed switching
 - ◆ Clamping circuits
- RF applications:
 - ◆ Diode ring mixer
 - ◆ RF detector
 - ◆ RF voltage doubler

1.4 Quick reference data

Table 2. Quick reference data

Symbol	Parameter	Conditions	Min	Typ	Max	Unit
I_F	continuous forward current		-	-	30	mA
V_R	continuous reverse voltage		-	-	15	V
C_d	diode capacitance	$V_R = 0$ V; $f = 1$ MHz; see Figure 4	-	1	-	pF

2. Pinning information

Table 3. Pinning

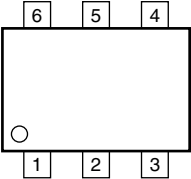
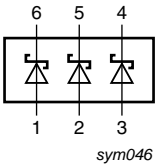
Pin	Description	Simplified outline	Symbol
1	anode (diode 1)	 001aab555	 sym046
2	anode (diode 2)		
3	anode (diode 3)		
4	cathode (diode 3)		
5	cathode (diode 2)		
6	cathode (diode 1)		

3. Ordering information

Table 4. Ordering information

Type number	Package		Version
	Name	Description	
1PS66SB82	-	plastic surface mounted package; 6 leads	SOT666
1PS88SB82	SC-88	plastic surface mounted package; 6 leads	SOT363

4. Marking

Table 5. Marking codes

Type number	Marking code
1PS66SB82	N5
1PS88SB82	E1*

- [1] * = -: made in Hong Kong
 * = p: made in Hong Kong
 * = t: made in Malaysia
 * = W: made in China

5. Limiting values

Table 6. Limiting values

In accordance with the Absolute Maximum Rating System (IEC 60134).

Symbol	Parameter	Conditions	Min	Max	Unit
V_R	continuous reverse voltage		-	15	V
I_F	continuous forward current		-	30	mA
T_j	junction temperature		-	125	°C
T_{amb}	ambient temperature		-65	+125	°C
T_{stg}	storage temperature		-65	+150	°C

6. Thermal characteristics

Table 7. Thermal characteristics

Symbol	Parameter	Conditions	Min	Typ	Max	Unit	
$R_{th(j-a)}$	thermal resistance from junction to ambient	in free air	[1]				
	SOT666		[2][3]	-	-	700	K/W
	SOT363		[3][4]	-	-	416	K/W

[1] For Schottky barrier diodes thermal run-away has to be considered, as in some applications the reverse power losses P_R are a significant part of the total power losses. Nomograms for determining the reverse power losses P_R and $I_{F(AV)}$ rating will be available on request.

[2] Refer to SOT666 standard mounting conditions.

[3] Reflow soldering is the only recommended soldering method.

[4] Refer to SOT363 (SC-88) standard mounting conditions.

7. Characteristics

Table 8. Characteristics

$T_{amb} = 25\text{ }^{\circ}\text{C}$ unless otherwise specified.

Symbol	Parameter	Conditions	Min	Typ	Max	Unit
V_F	forward voltage	see Figure 1	[1]			
		$I_F = 1\text{ mA}$	-	-	340	mV
		$I_F = 30\text{ mA}$	-	-	700	mV
I_R	reverse current	$V_R = 1\text{ V}$; see Figure 2	-	-	0.2	μA
r_{dif}	differential resistance	$I_F = 5\text{ mA}$; $f = 1\text{ kHz}$; see Figure 3	-	12	-	Ω
C_d	diode capacitance	$V_R = 0\text{ V}$; $f = 1\text{ MHz}$; see Figure 4	-	1	-	pF

[1] Pulse test: $t_p \leq 300\text{ }\mu\text{s}$; $\delta \leq 0.02$.

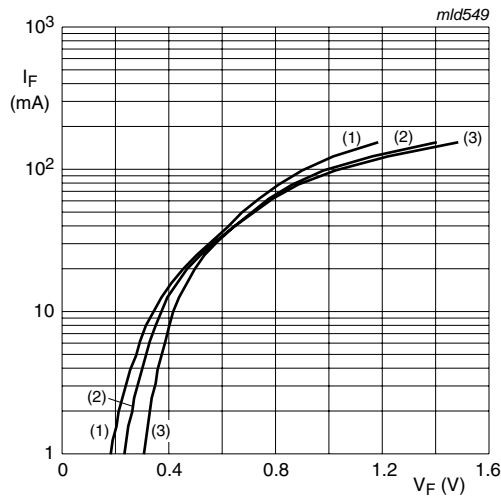

- (1) $T_{amb} = 125\text{ °C}$
- (2) $T_{amb} = 85\text{ °C}$
- (3) $T_{amb} = 25\text{ °C}$

Fig 1. Forward current as a function of forward voltage; typical values

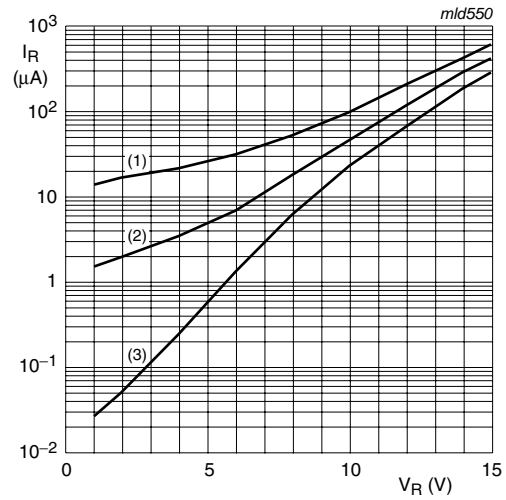

- (1) $T_{amb} = 125\text{ °C}$
- (2) $T_{amb} = 85\text{ °C}$
- (3) $T_{amb} = 25\text{ °C}$

Fig 2. Reverse current as a function of reverse voltage; typical values

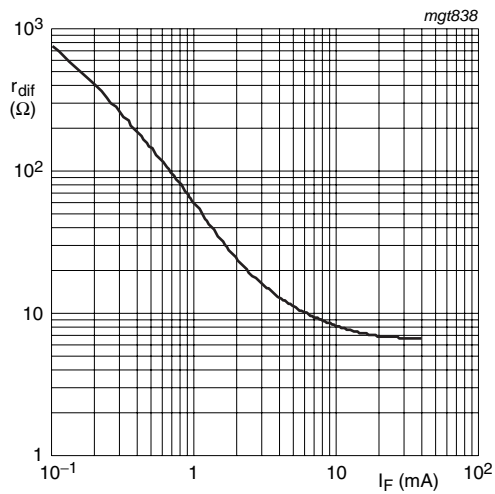

$f = 1\text{ kHz}; T_{amb} = 25\text{ °C}$

Fig 3. Differential diode forward resistance as a function of forward current; typical values

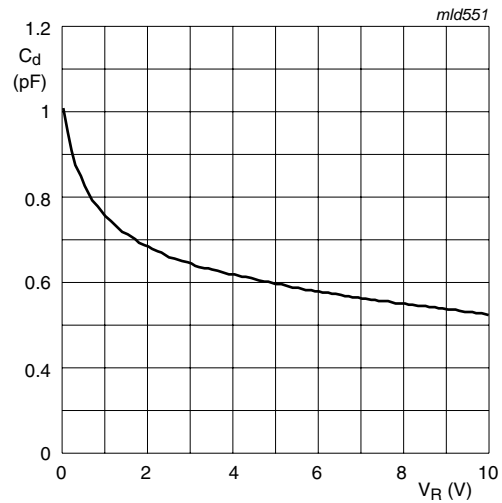

$f = 1\text{ MHz}; T_{amb} = 25\text{ °C}$

Fig 4. Diode capacitance as a function of reverse voltage; typical values

8. Package outline

Plastic surface-mounted package; 6 leads

SOT666

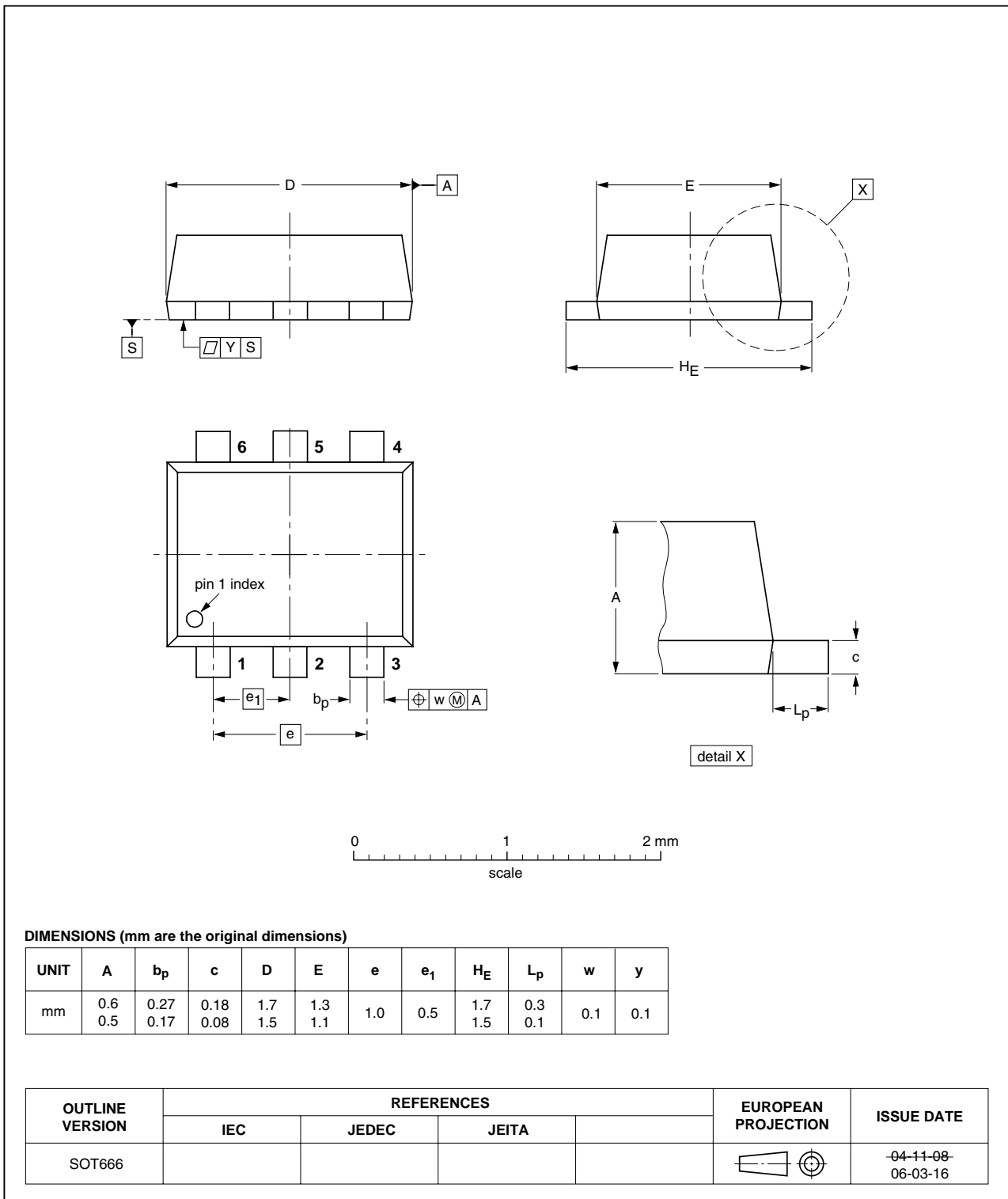

Fig 5. Package outline SOT666

Plastic surface-mounted package; 6 leads

SOT363

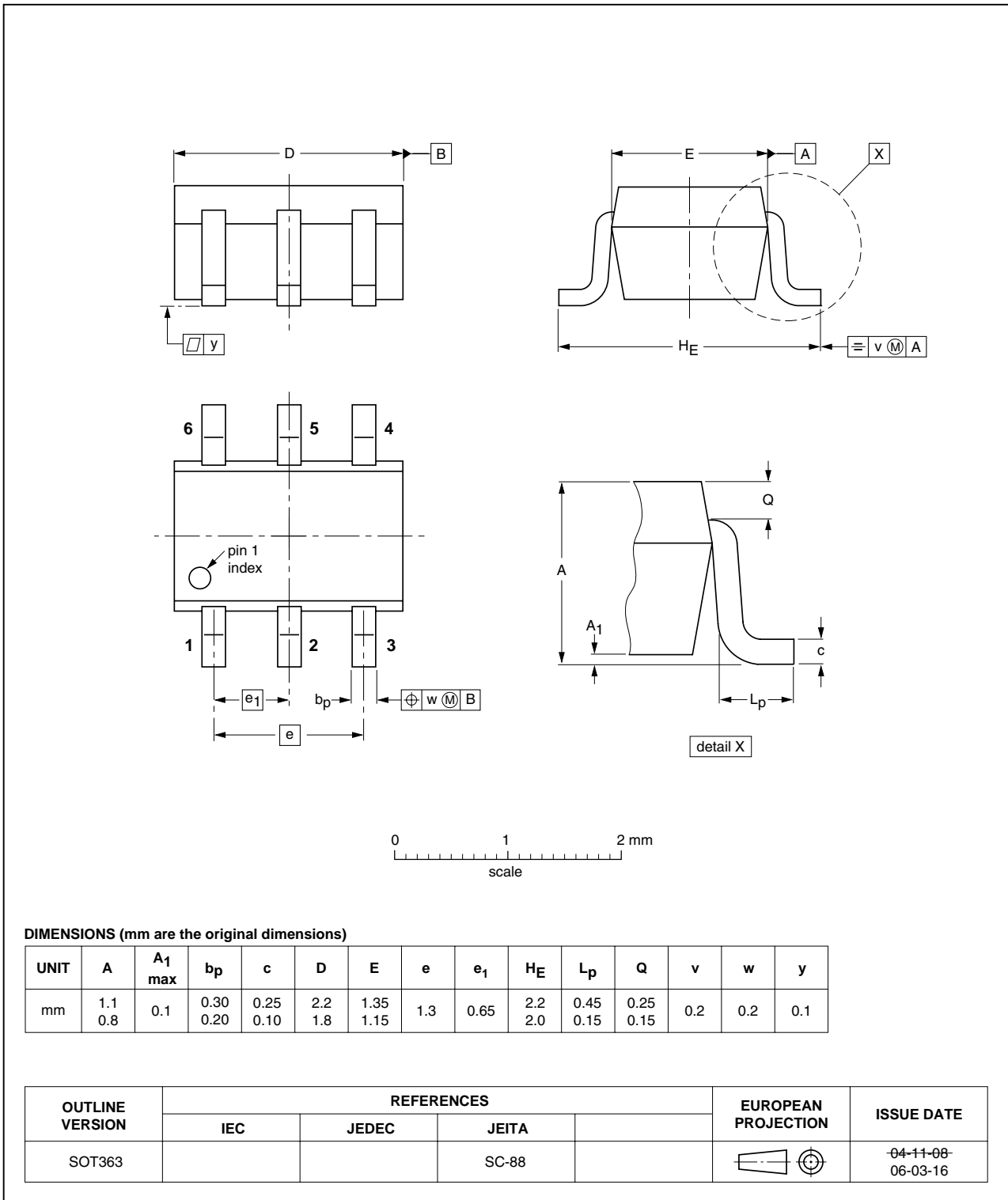

Fig 6. Package outline SOT363 (SC-88)

9. Packing information

Table 9. Packing methods

The -xxx numbers are the last three digits of the 12NC ordering code.^[1]

Type number	Package	Description	Packing quantity		
			3 000	4000	10 000
1PS66SB82	SOT666	4 mm pitch, 8 mm tape and reel	-	-115	-
1PS88SB82	SOT363	4 mm pitch, 8 mm tape and reel	-115	-	-135

[1] For further information and the availability of packing methods see [Section 12](#).

10. Revision history

Table 10. Revision history

Document ID	Release date	Data sheet status	Change notice	Supersedes
1PS66SB82_1PS88SB82_4	20100113	Product data sheet	-	1PS66SB82_1PS88SB82_3
Modifications:		<ul style="list-style-type: none"> This data sheet was changed to reflect the new company name NXP Semiconductors, including new legal definitions and disclaimers. No changes were made to the technical content. Table 3 "Pinning": updated Figure 5 "Package outline SOT666": updated Figure 6 "Package outline SOT363 (SC-88)": updated 		
1PS66SB82_1PS88SB82_3	20050124	Product data sheet	-	1PS88SB82_2
1PS88SB82_2	20030411	Product specification	-	1PS88SB82_1
1PS88SB82_1	20010216	Product specification	-	-

11. Legal information

11.1 Data sheet status

Document status ^{[1][2]}	Product status ^[3]	Definition
Objective [short] data sheet	Development	This document contains data from the objective specification for product development.
Preliminary [short] data sheet	Qualification	This document contains data from the preliminary specification.
Product [short] data sheet	Production	This document contains the product specification.

[1] Please consult the most recently issued document before initiating or completing a design.

[2] The term 'short data sheet' is explained in section "Definitions".

[3] The product status of device(s) described in this document may have changed since this document was published and may differ in case of multiple devices. The latest product status information is available on the Internet at URL <http://www.nexperia.com>.

11.2 Definitions

Draft — The document is a draft version only. The content is still under internal review and subject to formal approval, which may result in modifications or additions. Nexperia does not give any representations or warranties as to the accuracy or completeness of information included herein and shall have no liability for the consequences of use of such information.

Short data sheet — A short data sheet is an extract from a full data sheet with the same product type number(s) and title. A short data sheet is intended for quick reference only and should not be relied upon to contain detailed and full information. For detailed and full information see the relevant full data sheet, which is available on request via the local Nexperia sales office. In case of any inconsistency or conflict with the short data sheet, the full data sheet shall prevail.

11.3 Disclaimers

General — Information in this document is believed to be accurate and reliable. However, Nexperia does not give any representations or warranties, expressed or implied, as to the accuracy or completeness of such information and shall have no liability for the consequences of use of such information.

Right to make changes — Nexperia reserves the right to make changes to information published in this document, including without limitation specifications and product descriptions, at any time and without notice. This document supersedes and replaces all information supplied prior to the publication hereof.

Suitability for use — Nexperia products are not designed, authorized or warranted to be suitable for use in medical, military, aircraft, space or life support equipment, nor in applications where failure or malfunction of a Nexperia product can reasonably be expected to result in personal injury, death or severe property or environmental

damage. Nexperia accepts no liability for inclusion and/or use of Nexperia products in such equipment or applications and therefore such inclusion and/or use is at the customer's own risk.

Applications — Applications that are described herein for any of these products are for illustrative purposes only. Nexperia makes no representation or warranty that such applications will be suitable for the specified use without further testing or modification.

Limiting values — Stress above one or more limiting values (as defined in the Absolute Maximum Ratings System of IEC 60134) may cause permanent damage to the device. Limiting values are stress ratings only and operation of the device at these or any other conditions above those given in the Characteristics sections of this document is not implied. Exposure to limiting values for extended periods may affect device reliability.

Terms and conditions of sale — Nexperia products are sold subject to the general terms and conditions of commercial sale, as published at <http://www.nexperia.com/profile/terms>, including those pertaining to warranty, intellectual property rights infringement and limitation of liability, unless explicitly otherwise agreed to in writing by Nexperia. In case of any inconsistency or conflict between information in this document and such terms and conditions, the latter will prevail.

No offer to sell or license — Nothing in this document may be interpreted or construed as an offer to sell products that is open for acceptance or the grant, conveyance or implication of any license under any copyrights, patents or other industrial or intellectual property rights.

Export control — This document as well as the item(s) described herein may be subject to export control regulations. Export might require a prior authorization from national authorities.

Quick reference data — The Quick reference data is an extract of the product data given in the Limiting values and Characteristics sections of this document, and as such is not complete, exhaustive or legally binding.

11.4 Trademarks

Notice: All referenced brands, product names, service names and trademarks are the property of their respective owners.

12. Contact information

For more information, please visit: <http://www.nexperia.com>

For sales office addresses, please send an email to: salesaddresses@nexperia.com

13. Contents

1	Product profile	1
1.1	General description	1
1.2	Features	1
1.3	Applications	1
1.4	Quick reference data	1
2	Pinning information	2
3	Ordering information	2
4	Marking	2
5	Limiting values	2
6	Thermal characteristics	3
7	Characteristics	3
8	Package outline	5
9	Packing information	7
10	Revision history	8
11	Legal information	9
11.1	Data sheet status	9
11.2	Definitions	9
11.3	Disclaimers	9
11.4	Trademarks	9
12	Contact information	9
13	Contents	10

Mouser Electronics

Authorized Distributor

Click to View Pricing, Inventory, Delivery & Lifecycle Information:

[Nexperia:](#)

[1PS66SB82,115](#)