

CDM10V-4

A 0-10V Dimming Solution

Feature list

- Simplest 0-10 V design on the market. CDM10V-4 comes with following key settings:
 - 2kHz PWM frequency
 - 100 μ A Dimmer/Resistor Bias current
 - Dim-to-off
- Wide input V_{CC} range from 11 to 25 V
- Replaces many external components with a single chip reducing BOM and PCB space
- Minimum variation from device to device

Potential applications

- LED Drivers needing 0-10 V Dimming Circuits
- Industrial and Commercial Dimmable Applications:
Luminaires, Troffers, Downlights, Sconces, Undercabinet, Office Lighting, Signage applications, Dali applications

Product Type	Package
CDM10V-4	SOT23-6

Product validation

Qualified for applications listed above based on the test conditions in the relevant tests of JEDEC20/22.

Description

CDM10V-4 is a fully integrated 0-10 V dimming interface IC and comes in a SOT-23-6 package to cover space requirements on small PCBs.

The device is targeted for various dimming applications in lighting. The IC can be used to transmit analog voltage based signals from a 0-10 V dimmer or potentiometer to the dimming or PWM input of a lighting controller IC in the form of a 5 mA current based PWM signal to drive an external opto-coupler. It replaces many components in a traditional solution and reduces BOM and PCB space significantly.

The CDM10V-4 IC outputs a 0 - 100% PWM current signal at 2 kHz with an amplitude value of 5 mA.

Embedded digital signal processing maintains minimum variations from device to device.

Table of contents

	Feature list	1
	Potential applications	1
	Product validation	1
	Description	1
	Table of contents	2
1	Block diagram reference	3
2	Pin configuration	3
3	Functional description	4
4	Electrical characteristics and parameters	7
5	Package dimensions	9
6	References	11
	Revision history	11
	Trademarks	12

Block diagram reference

1 Block diagram reference

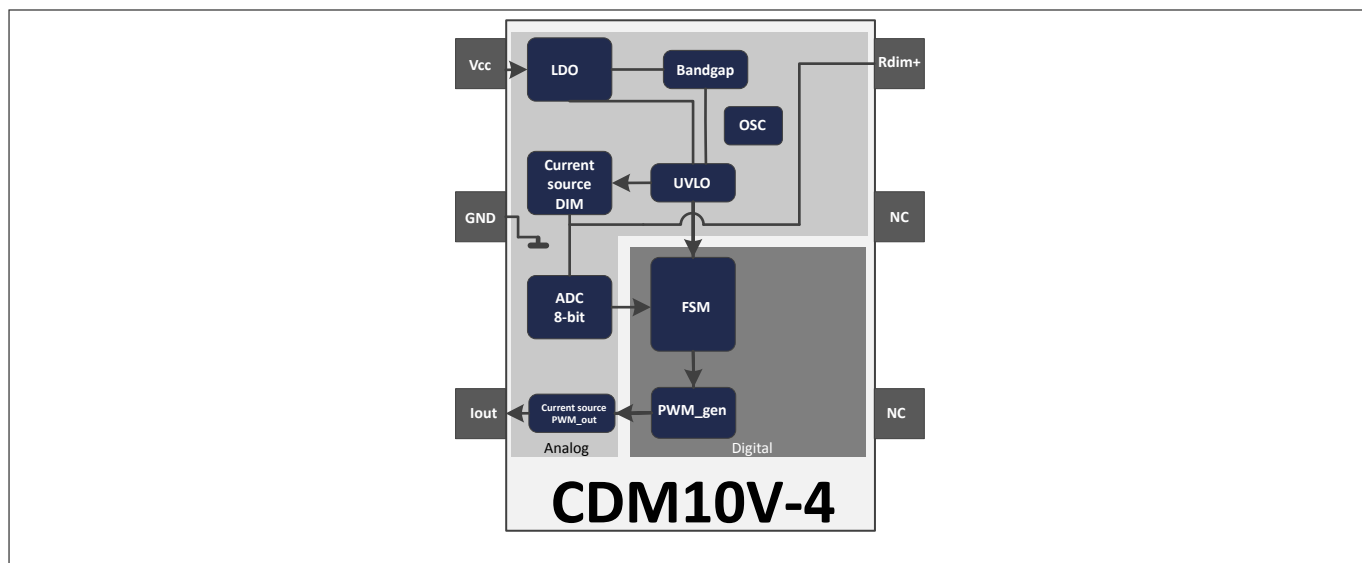

Figure 1 Block Diagram of the CDM10V-4

2 Pin configuration

Table 1 Pin configuration

Pin	Name	Function
1	V _{CC}	Input supply voltage
2	GND	GND
3	I _{out}	PWM output current
4	NC	GND
5	NC	GND
6	R _{dim+}	Dimmer current output /Voltage sense

Functional description

3 Functional description

Typical Application Circuit

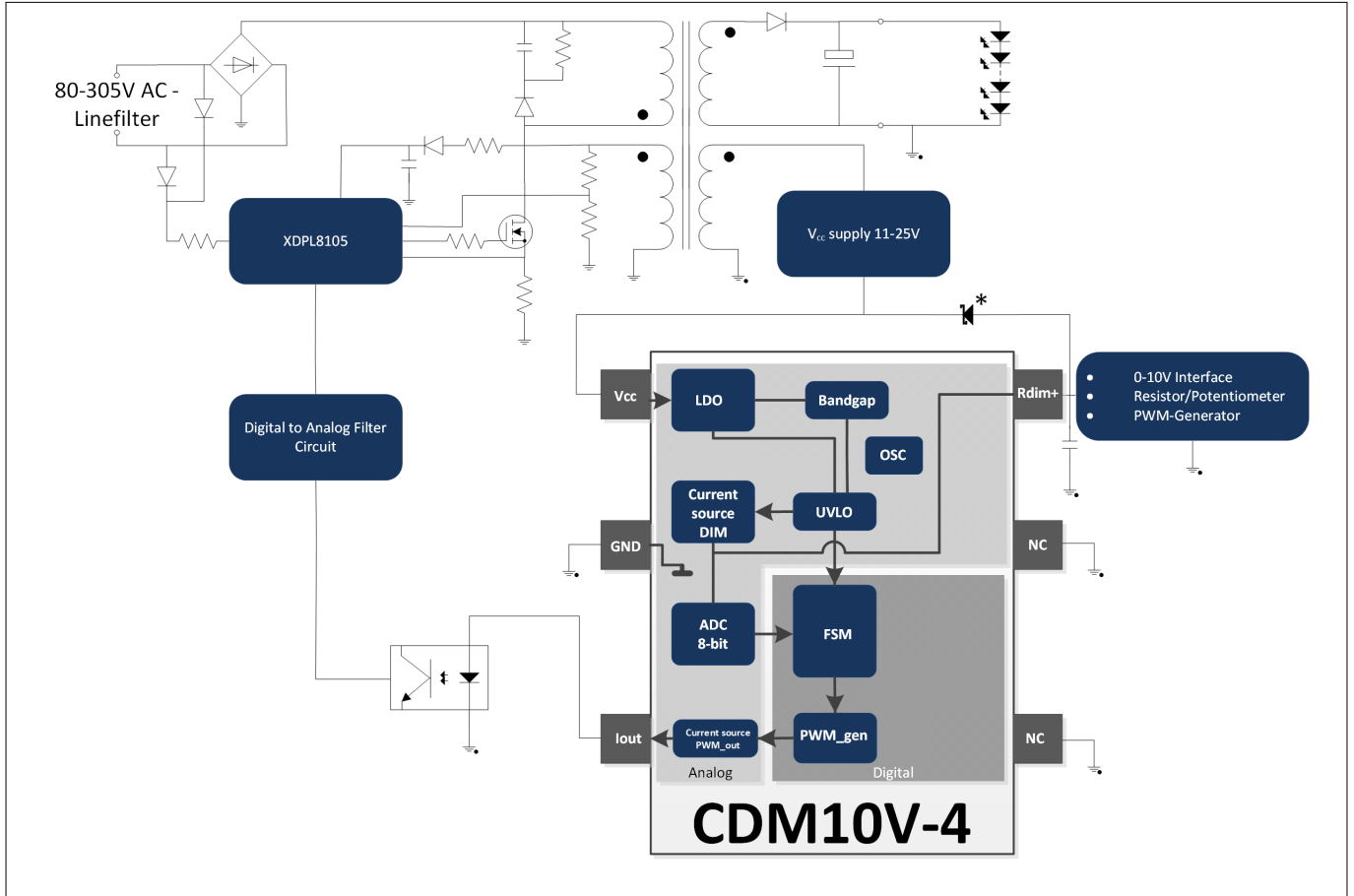

Figure 2 Typical Application Circuit

Note: The Diode marked with * is for the protection of the R_{dim+} -Pin when active dimming is used. This is because the voltage on this Pin is not allowed to be higher than $V_{CC}+0.5V$. It is advised to use a low leakage, low reverse current Schottky-Diode in order to not influence the dimming performance (e.g. MMSD301T1G).

Note: The capacitor connected to the R_{dim+} -Pin reduces the amount of coupled noise to the dimming signal. The size of this capacitance should be in the range of 2.2 - 10 nF (typ. 4.7 nF), where a small capacitor allows steeper edges of the dimming signal, a larger capacitor enhances the noise reduction.

Recommended cooling area

In order to guarantee the full functionality of the CDM10V-4 device, the required cooling area has to be selected according to the graph in [Figure 3](#).

Functional description

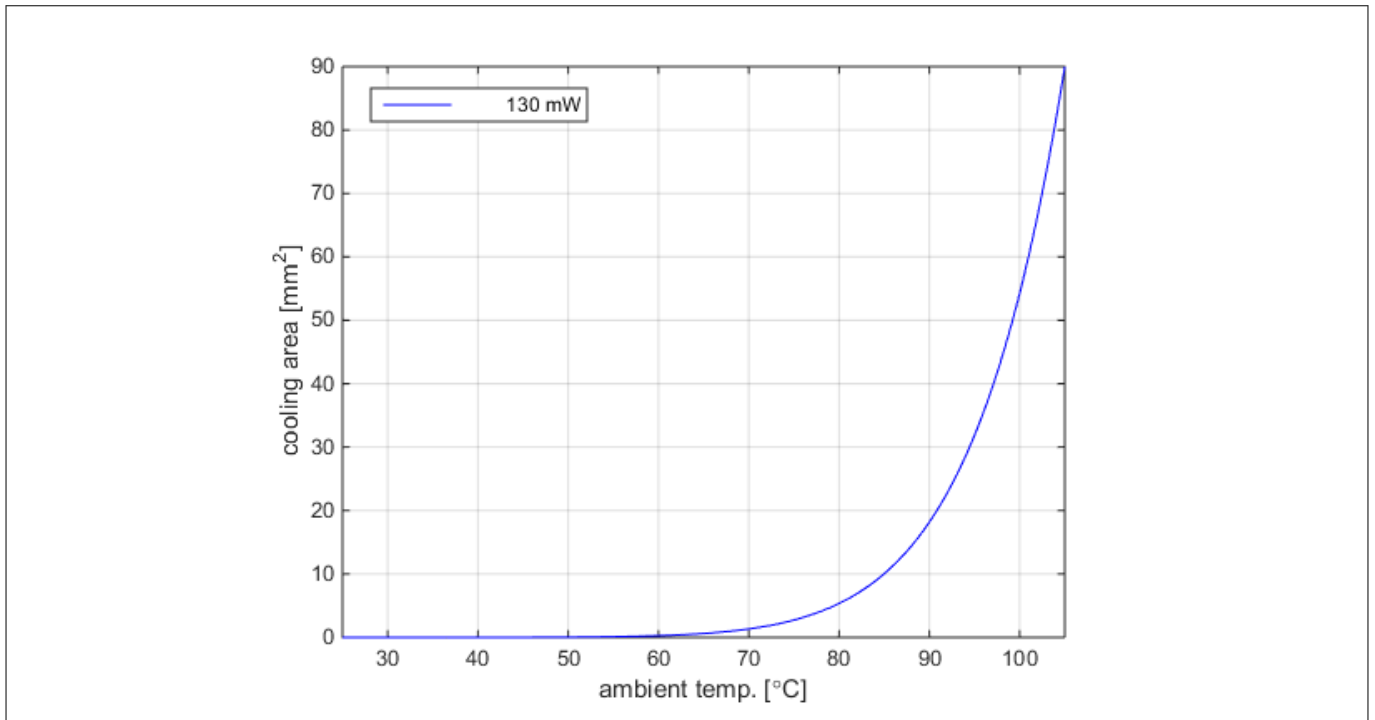

Figure 3 Cooling area over ambient temperature CDM10V-4

Functional description

Dimming Characteristic

Table 2 PWM Output current referring to R_{dim+} -Pin Voltage

R_{dim+}	I_{out}
<1 V	Dim-to-Off
1 - 9 V	1...100% (@ 9V)
>9V (max. applicable Voltage: V_{CC})	Always active

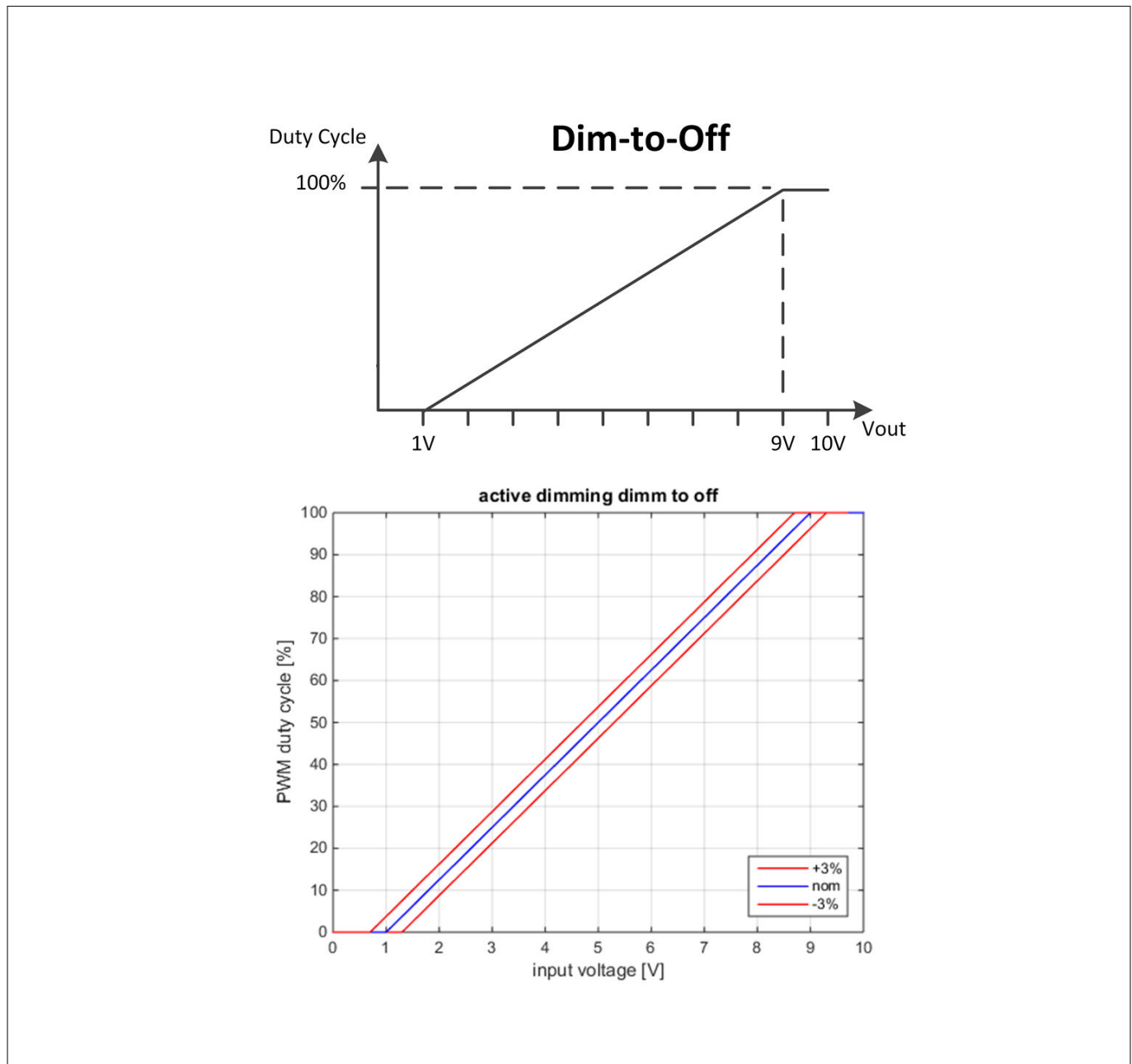

Figure 4 Dimming Characteristic

Electrical characteristics and parameters

4 Electrical characteristics and parameters

Table 3 Absolute Maximum Ratings

Pin	Name	Values		Unit	Note or Test Condition
		Min.	Max.		
1	V_{CC}	11	25	V	
2	GND	0	0	V	Point of reference
3	I_{out}	-0.5	3.63	V	Depending on the optocoupler voltage @ 5mA
4	NC	-0.25	0.1	V	Connect to GND during operation
5	NC	-0.25	0.1	V	Connect to GND during operation
6	R_{dim+}	-0.5	$V_{CC} + 0.5$	V	An applied voltage above max value leads to the destruction of the device. Also valid if V_{CC} is 0 V.

Absolute maximum ratings (**Table 3**) are defined as ratings which when being exceeded may lead to destruction of the integrated circuit. Exposure to absolute maximum rating conditions for extended periods may affect device reliability. Maximum ratings are absolute ratings; exceeding only one of these values may cause irreversible damage to the integrated circuit. These values are not tested during production test.

Table 4 Electrical Characteristics

Parameter	Symbol	Values			Unit	Note or Test Condition
		Min.	Typ.	Max.		
Input Voltage	V_{in}	11		25	V	Operating Voltage
Junction Temperature Range	T_J	-40		135	°C	
Ambient Temperature Range	T_A	-40		105	°C	
Power Dissipation	P_{tot}	6.05 @ 1% duty cycle;	130 @ 100% duty cycle 54 @ 50% duty cycle	160 @ 100% PWM & 25 V_{in}	mW	Dimmer current included
Current Consumption	I_{CC}			1	mA	Current Consumption of the IC for self supply
Output Current for Dimmer	I_{dim}	-10%	100	+10%	µA	Current flow out of R_{dim+} -Pin
Output Current for Optocoupler	I_{out}	-10%	5	+10%	mA	

Electrical characteristics and parameters

Table 4 Electrical Characteristics (continued)

Parameter	Symbol	Values			Unit	Note or Test Condition
		Min.	Typ.	Max.		
Dimming accuracy		-3		+3	%	With active dimming incl. all variations
PWM frequency	f_{PWM}	-6%	2000	+6%	Hz	
Wake-up Time	t_w			40	μs	Time from $V_{\text{CC}} = 11\text{ V}$ to first output current
ESD capability HBM	V_{HBM}			1500	V	according to ANSI/ESDA/JEDEC JS-001
ESD capability CDM	V_{CDM}			500		according to JESD22 C101

Package dimensions

5 Package dimensions

Package Drawings

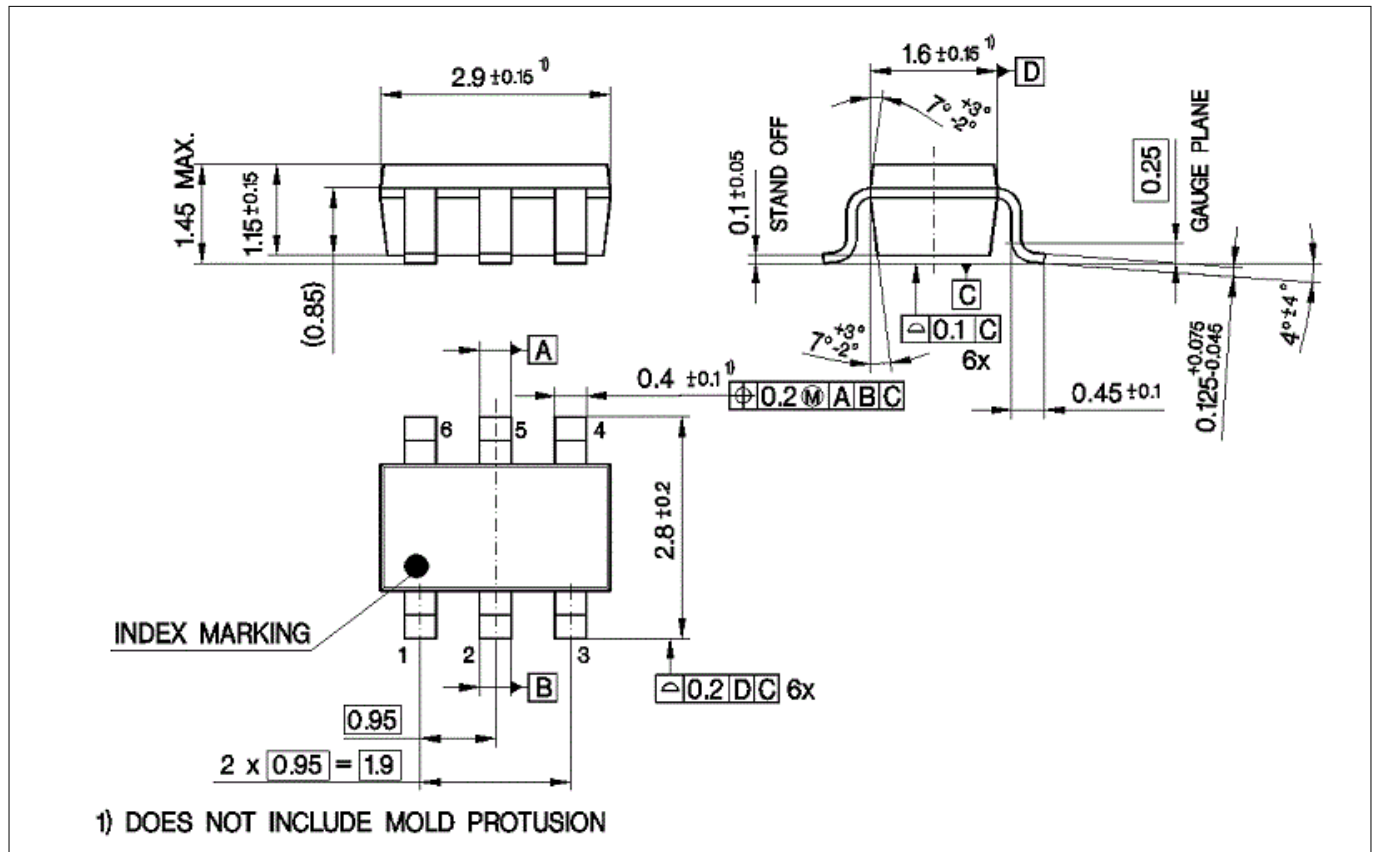

Figure 5 Package Drawings

Package dimensions

Footprint

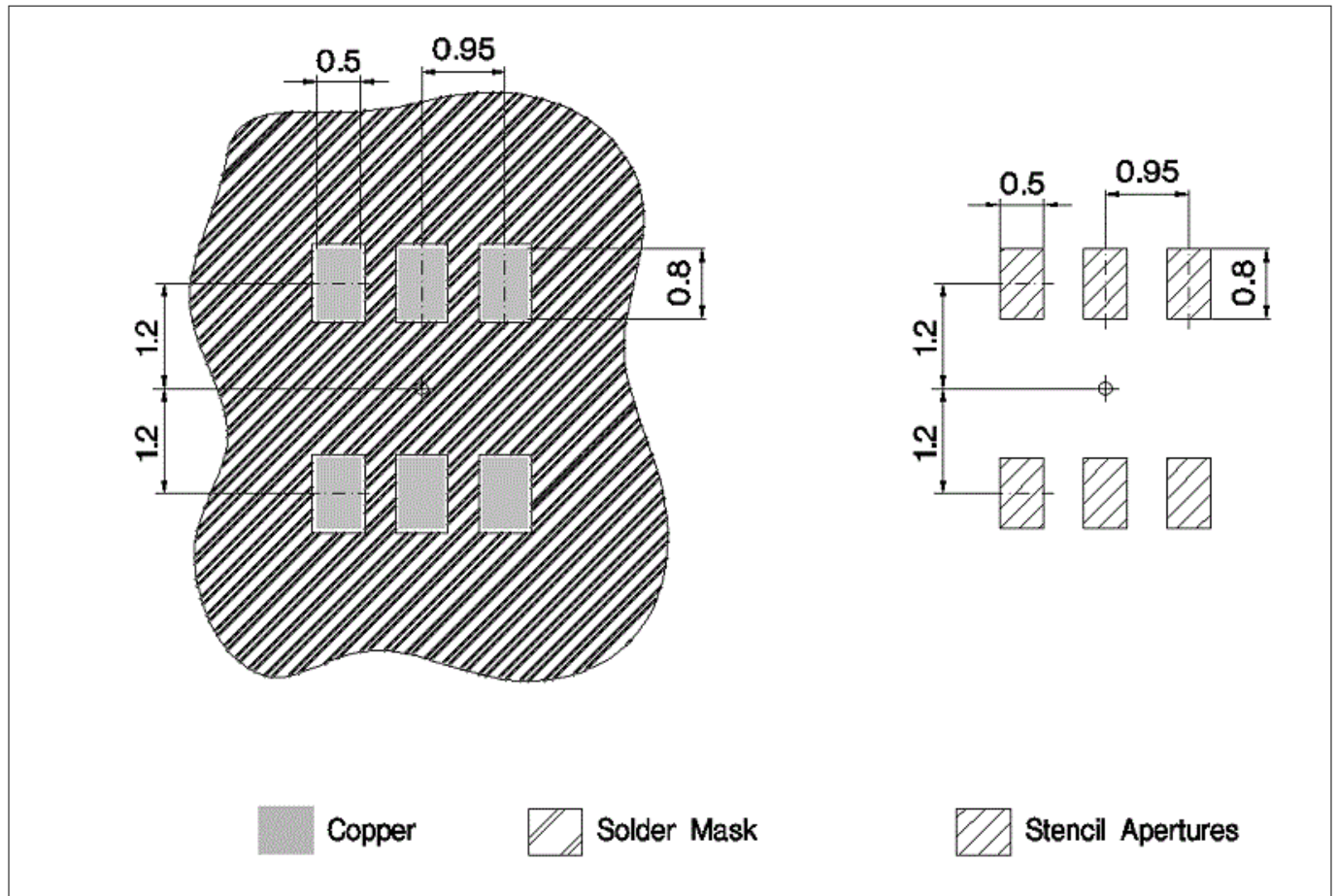

Figure 6 Footprint

Packing Description

Packing Type

Tape and Reel
 Ø Reel: 180
 Pieces / Reel: 3000
 Reels / Box: 1

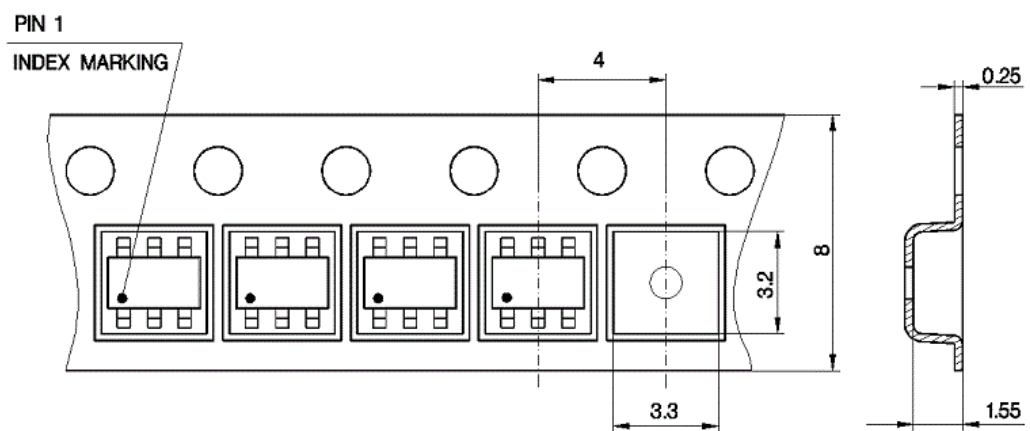

Figure 7 Packing

References

6 References

Additional support material can be found under the following link.

Related information

<http://www.infineon.com/CDM10V>

Revision history

Document version	Date of release	Description of changes
1.0	14.07.2017	<ul style="list-style-type: none">Initial Version
1.1	04.08.2017	<ul style="list-style-type: none">Changed misleading picture (figure 4)

Trademarks

All referenced product or service names and trademarks are the property of their respective owners.

Edition 2017-08-04

Published by
Infineon Technologies AG
81726 Munich, Germany

© 2017 Infineon Technologies AG
All Rights Reserved.

Do you have a question about any aspect of this document?
Email: erratum@infineon.com

Document reference
IFX-src1499941097267

IMPORTANT NOTICE

The information given in this document shall in no event be regarded as a guarantee of conditions or characteristics ("Beschaffheitsgarantie").

With respect to any examples, hints or any typical values stated herein and/or any information regarding the application of the product, Infineon Technologies hereby disclaims any and all warranties and liabilities of any kind, including without limitation warranties of non-infringement of intellectual property rights of any third party.

In addition, any information given in this document is subject to customer's compliance with its obligations stated in this document and any applicable legal requirements, norms and standards concerning customer's products and any use of the product of Infineon Technologies in customer's applications.

The data contained in this document is exclusively intended for technically trained staff. It is the responsibility of customer's technical departments to evaluate the suitability of the product for the intended application and the completeness of the product information given in this document with respect to such application.

WARNINGS

Due to technical requirements products may contain dangerous substances. For information on the types in question please contact your nearest Infineon Technologies office.

Except as otherwise explicitly approved by Infineon Technologies in a written document signed by authorized representatives of Infineon Technologies, Infineon Technologies' products may not be used in any applications where a failure of the product or any consequences of the use thereof can reasonably be expected to result in personal injury