

DIELECTRIC RESONATOR-BASED VOLTAGE CONTROLLED OSCILLATORS (VCO)

MQC/MQE Series

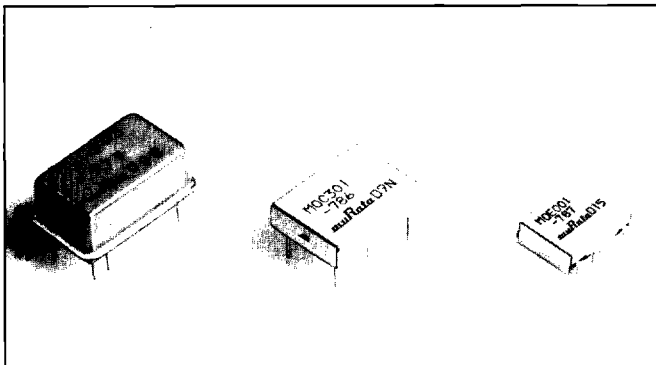

FEATURES

- Small and lightweight.
- Low power consumption
- Excellent temperature stability

APPLICATIONS

Mobile and Hand Held Telephone
 Cordless Telephone (European)
 Personal Radio
 MCA Radio

DIMENSIONS: mm

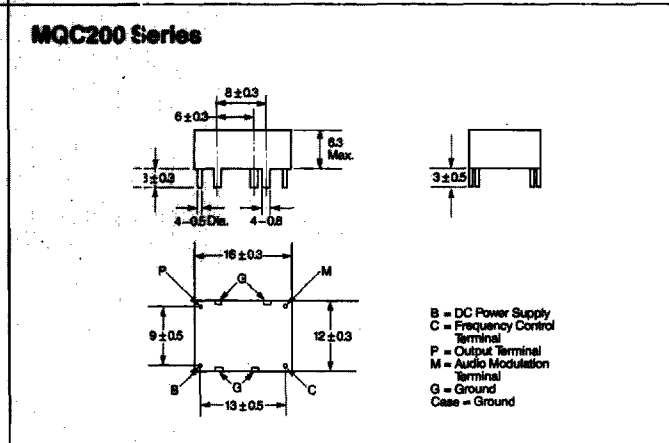
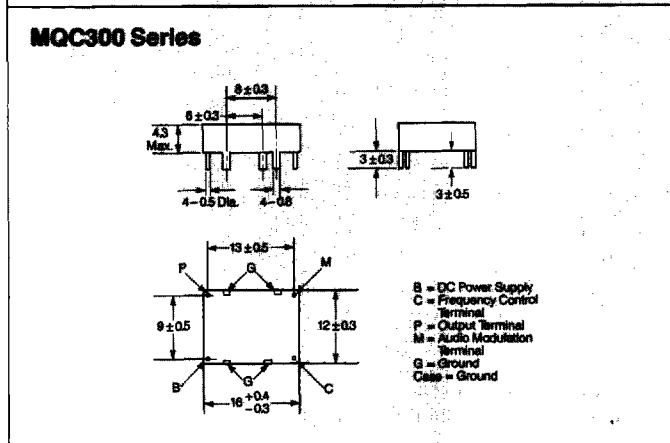
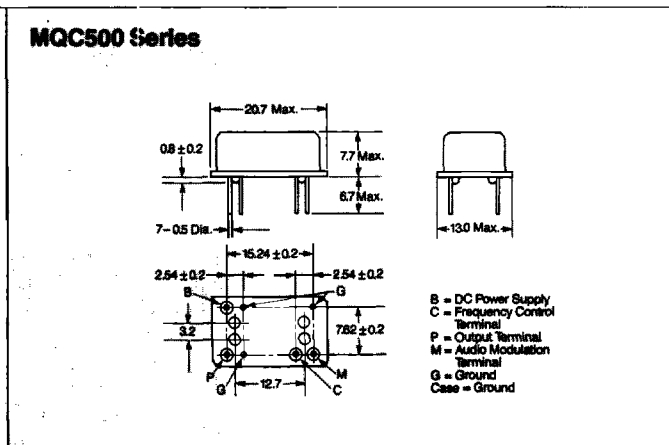
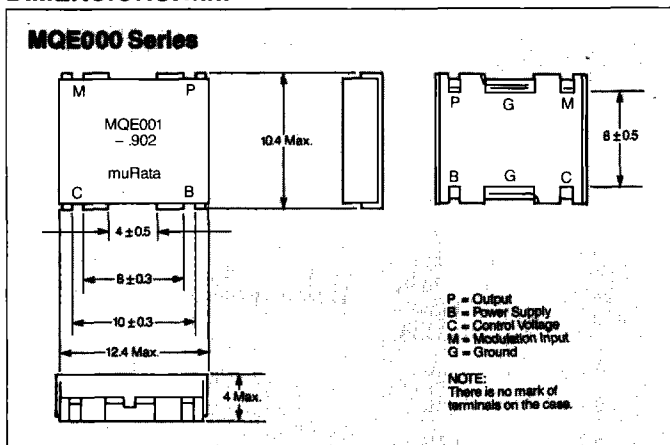

PART NUMBERING

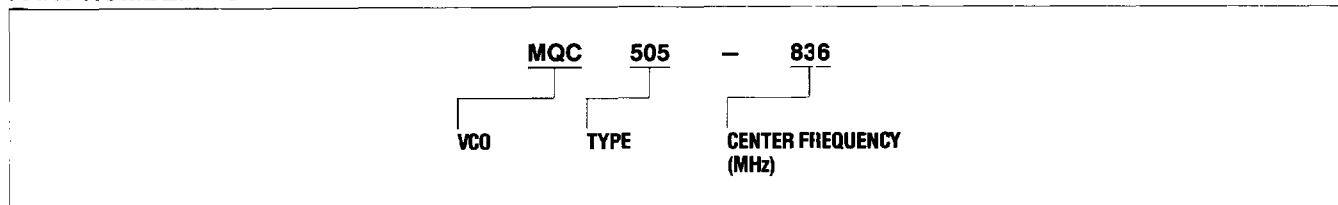

EAMPS

Application	Part Number	Oscillation Frequency (MHz)	Control Volt. Sensitivity (MHz/V)	Tuning Volt. Range (V)	Audio Modulation Sensitivity (KHz/Vp-p)	Audio Modulation Sensitivity Deviation (% max.)	C/N (dBmin.)	S/N (dBmin.)	Operation Temperature (°C)
Tx	MQC505-836	836.5 ± 12.5	11 ± 2	1.0 to 4.0	8 to 12	± 10	72	45	-35 to +80
	MQC309-836	836.5 ± 12.5	11 ± 2	1.0 to 4.0	8 to 12	± 10	70	45	-35 to +80
	MQE001-836	836.5 ± 12.5	≥ 9.0	1.0 to 4.0	8 to 12	± 10	70	45	-35 to +80
Rx	MQC505-926	926.5 ± 12.5	11 ± 2	1.0 to 4.0	—	—	72	45	-35 to +80
	MQC505-964	964.5 ± 12.5	11 ± 2	1.0 to 4.0	—	—	72	45	-35 to +80
	MQC309-926	926.5 ± 12.5	11 ± 2	1.0 to 4.0	—	—	70	45	-35 to +80
	MQC309-964	964.5 ± 12.5	11 ± 2	1.0 to 4.0	—	—	70	45	-35 to +80
	MQE001-926	926.5 ± 12.5	≥ 9.0	1.0 to 4.0	—	—	70	45	-35 to +80
	MQE001-964	964.5 ± 12.5	≥ 9.0	1.0 to 4.0	—	—	70	45	-35 to +80

*Supply Voltage 5 ± 0.25V (MQC508=7.2 ± 0.3V, MQC514=7.0 ± 0.5V, MQE001=4.2V ± 0.25V)
 Output Level -2dBm min. (MQC508=0dBm min., MQE001=-3dBm min.)
 Power Consumption 8mA max. (MQC508=12mA max.)

ETACS

Application	Part Number	Oscillation Frequency (MHz)	Control Volt. Sensitivity (MHz/V)	Tuning Volt. Range (V)	Audio Modulation Sensitivity (KHz/Vp-p)	Audio Modulation Sensitivity Deviation (% max.)	C/N (dBmin.)	S/N (dBmin.)	Operation Temperature (°C)
Tx	MQC505-888	888.5 ± 16.5	13 ± 2	1.0 to 4.0	8 to 12	± 10	72	45	-35 to +80
	MQC309-888	888.5 ± 16.5	13 ± 2	1.0 to 4.0	8 to 12	± 10	70	45	-35 to +80
	MQE001-888	888.5 ± 16.5	≥ 11.0	1.0 to 4.0	8 to 12	± 10	70	45	-35 to +80
Rx	MQC505-978	978.5 ± 16.5	13 ± 2	1.0 to 4.0	—	—	72	45	-35 to +80
	MQC508-1024	1024.5 ± 16.5	9 ± 2	1.0 to 6.0	—	—	75	50	-35 to +80
	MQC309-978	978.5 ± 16.5	13 ± 2	1.0 to 4.0	—	—	70	45	-35 to +80
	MQE001-978	978.5 ± 16.5	≥ 11.0	1.0 to 4.0	—	—	70	45	-35 to +80
	MQE001-1025	1025.5 ± 16.5	≥ 11.0	1.0 to 4.0	—	—	70	45	-35 to +80

*Supply Voltage 5 ± 0.25V (MQC508=7.2 ± 0.5V, MQE001=4.2V ± 0.25V)
 Output Level -2dBm min. (MQC508=0dBm min., MQE001=-3dBm min.)
 Power Consumption 8mA max. (MQC508=12mA max.)

NMT

Application	Part Number	Oscillation Frequency (MHz)	Control Volt. Sensitivity (MHz/V)	Tuning Volt. Range (V)	Audio Modulation Sensitivity (KHz/Vp-p)	Audio Modulation Sensitivity Deviation (% max.)	C/N (dBmin.)	S/N (dBmin.)	Operation Temperature (°C)
Tx	MQC505-902	902.5 ± 12.5	11 ± 2	1.0 to 4.0	8 to 12	± 10	72	45	-35 to +80
	MQC202-902	902.5 ± 12.5	11 ± 2	1.0 to 4.0	8 to 12	± 10	72	45	-35 to +80
	MQE001-902	902.5 ± 12.5	≥ 9.0	1.0 to 4.0	8 to 12	± 10	72	45	-35 to +80
Rx	MQC505-992	992.5 ± 12.5	11 ± 2	1.0 to 4.0	—	—	72	45	-35 to +80
	MQC505-1017	1017.5 ± 12.5	11 ± 2	1.0 to 4.0	—	—	72	45	-35 to +80
	MQC202-992	992.5 ± 12.5	11 ± 2	1.0 to 4.0	—	—	72	45	-35 to +80
	MQE001-992	992.5 ± 12.5	≥ 9.0	1.0 to 4.0	—	—	72	45	-35 to +80

*Supply Voltage 5 ± 0.25V (MQC508=7.2 ± 0.3V, MQE001=4.2V ± 0.25V)
 Output Level -2dBm min. (MQC508=0dBm min., MQE001=-3dBm min.)
 Power Consumption 8mA max. (MQC508=12mA max.)

GSM

Application	Part Number	Oscillation Frequency (MHz)	Control Volt. Sensitivity (MHz/V)	Tuning Volt. Range (V)	Audio Modulation Sensitivity (KHz/Vp-p)	Audio Modulation Sensitivity Deviation (% max.)	C/N (dBmin.)	S/N (dBmin.)	Operation Temperature (°C)
Tx	MQC505-902	902.5±12.5	11±2	1.0 to 4.0	8 to 12	±10	72	45	-35 to +80
	MQC309-902	902.5±12.5	11±2	1.0 to 4.0	8 to 12	±10	68	45	-35 to +80
Rx	MQC505-992	992.5±12.5	11±2	1.0 to 4.0	--	--	72	45	-35 to +80
	MQC505-1017	1017.5±12.5	11±2	1.0 to 4.0	--	--	72	45	-35 to +80
	MQC309-992	992.5±12.5	11±2	1.0 to 4.0	--	--	68	45	-35 to +80

*Supply Voltage 5±0.25V Output Level -2dBm min. Power Consumption 8mA max.

CORDLESS (EUROPEAN) – CEPT40, CEPT80(ANALOG)/CT-2(DIGITAL)

Application	Part Number	Oscillation Frequency (MHz)	Control Volt. Sensitivity (MHz/V)	Tuning Volt. Range (V)	Audio Modulation Sensitivity (KHz/Vp-p)	Audio Modulation Sensitivity Deviation (% max.)	C/N (dBmin.)	S/N (dBmin.)	Operation Temperature (°C)
Tx	MQC506-886	886.0±1.0	4±2	1.5 to 3.5	8 to 12	±5	70	45	-10 to +60
	MQC506-914	914.5±0.5	3.5±2	1.5 to 3.5	8 to 12	±5	70	45	-10 to +60
	MQC506-931	931.0±1.0	4±2	1.5 to 3.5	8 to 12	±5	70	45	-10 to +60
	MQC506-959	959.5±0.5	3.5±2	1.5 to 3.5	8 to 12	±5	70	45	-10 to +60
	MQC513-716	716.0±12.5	12±2	1.0 to 4.0	5.6 to 8.4	±10	75	45	-10 to +60
	MQC308-886	886.0±1.0	5±2	1.0 to 3.5	16 to 24	±5	66	45	-10 to +60
	MQC308-931	931.0±1.0	5±2	1.0 to 3.5	16 to 24	±5	66	45	-10 to +60
Rx	MQC506-828	828.0±2.0	4±2	1.0 to 4.0	--	--	70	45	-10 to +60
	MQC506-856	856.5±1.5	4±2	1.5 to 3.5	--	--	70	45	-10 to +60
	MQC506-989	989.0±2.0	4±2	1.0 to 4.0	--	--	70	45	-10 to +60
	MQC506-1017	1017.5±1.5	4±2	1.5 to 3.5	--	--	70	45	-10 to +60
	MQC513-860	860.65±7.35	8±2	1.0 to 4.0	--	--	70	45	-10 to +60
	MQC308-827	827.9±1.0	5±2	1.0 to 3.5	--	--	68	45	-10 to +60
	MQC308-872	872.9±1.0	5±2	1.0 to 3.5	--	--	68	45	-10 to +60

*Supply Voltage 5±0.25V (MQC506-828/989=4.5±0.25V, MQC308=4.0±0.2V) Output Level -2dBm min. (MQC308=0±3dBm) Power Consumption 8mA max.

**Oscillation frequency and supply voltage can be changed upon request. Consult us for further information.

GPS, MSAT AND SATELLITE RECEIVERS

Application	Part Number	Oscillation Frequency (MHz)	Control Volt. Sensitivity (MHz/V)	Tuning Volt. Range (V)	Audio Modulation Sensitivity (KHz/Vp-p)	Audio Modulation Sensitivity Deviation (% max.)	C/N (dBmin.)	S/N (dBmin.)	Operation Temperature (°C)
GPS	MQC530-1395	1395±4.5	≥3.0	1.0 to 4.0	--	--	70	--	-40 to +85
	MQC530-1485	1485.44±3.0	≥3.0	1.0 to 4.0	--	--	75	--	-40 to +85
MSAT	MQC530-1465	1465±13.0	≥6.0	2.0 to 6.5	--	--	110	--	-30 to +85

*Supply Voltage 5±0.25V Output Level -2dBm min. Power Consumption 8mA max.

SPREAD SPECTRUM

Application	Part Number	Oscillation Frequency (MHz)	Control Volt. Sensitivity (MHz/V)	Tuning Volt. Range (V)	Audio Modulation Sensitivity (KHz/Vp-p)	Audio Modulation Sensitivity Deviation (% max.)	C/N (dBmin.)	S/N (dBmin.)	Operation Temperature (°C)
Spread Spectrum	MQC505-915	915.5 ± 12.5	≥ 9.0	1.0 to 4.0	—	—	70	45	-35 to +80
	MQC515-915	915.5 ± 12.5	≥ 9.0	1.0 to 4.0	100	± 10	70	45	-35 to +80

*Supply Voltage 5 ± 0.25V Output Level -2dBm min. Power Consumption 8mA max.

VCO TYPICAL CHARACTERISTICS (MQC505-978)

Oscillation Frequency vs. Temperature Characteristics

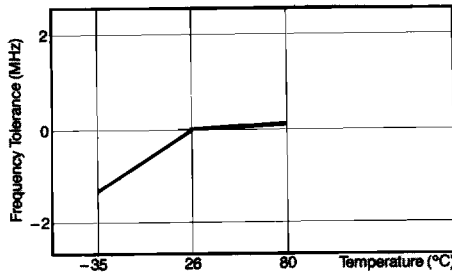

C/N Level – MQC505-978

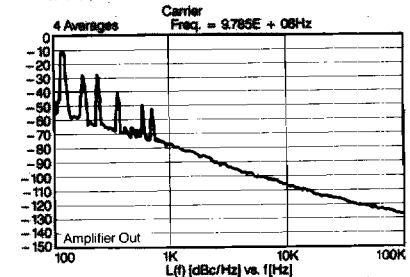

C/N Level – Oscillation Frequency

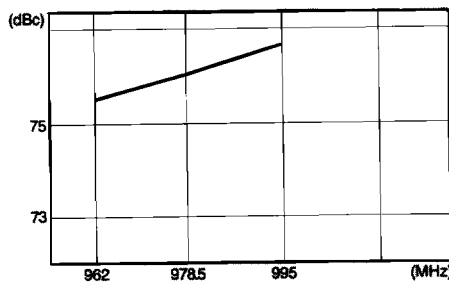

Test Circuit – MQC500/300/200

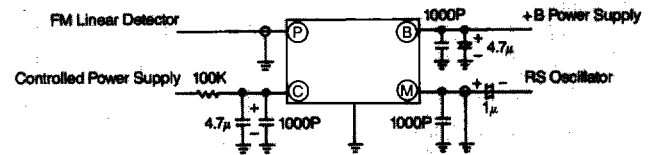

MOUNTING AND PACKAGING – MQEO

Recommended Mounting Dimensions: mm

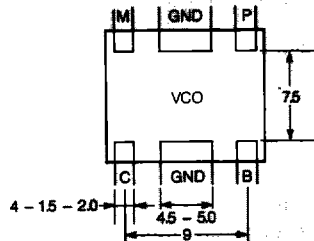

Reflow Soldering Condition

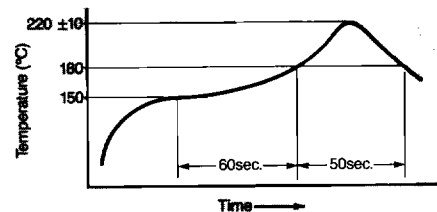

Taping Specifications: mm

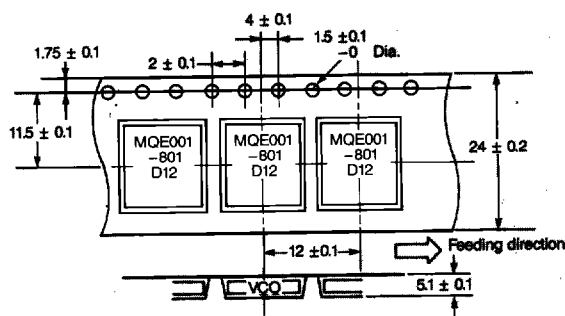

Reel dimensions: mm

