



# Miniature power relays 12 A



Industrial furnaces and ovens



Control and management of electric power



Industrial motors



Circuit breakers and switches



Panels for electrical distribution



Control panels



Carousel warehouses



Vending machines

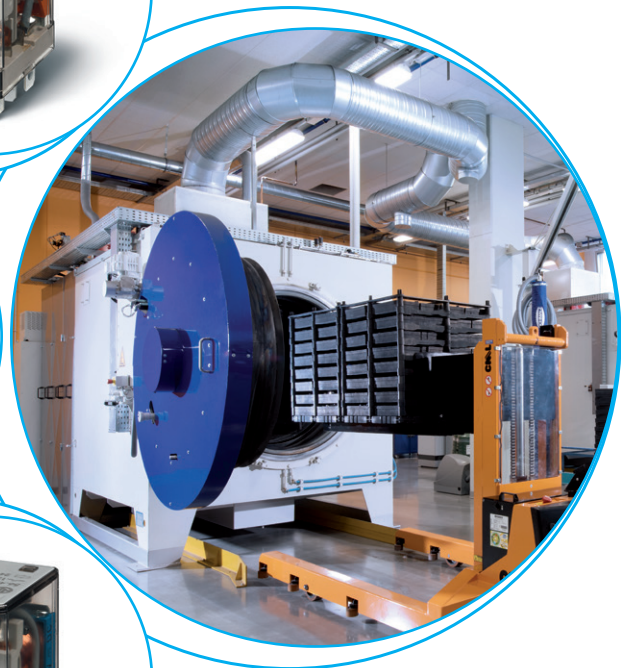
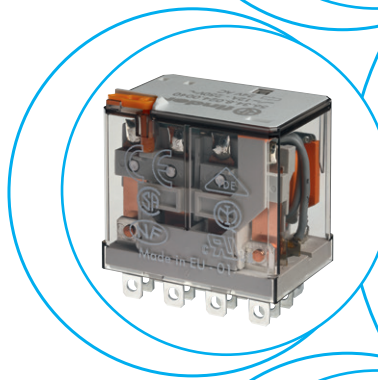



**Plug-in - 12 A Power relay, 2 & 4 pole**

- Flange mount option - (Faston 187, 4.8 x 0.5 mm termination)
- AC coils & DC coils
- Lockable test button and mechanical flag indicator
- Cadmium Free contacts (standard version)
- Contact material options
- 96 series sockets
- Coil EMC suppression
- Accessories
- European Patent

**56.32/56.34**

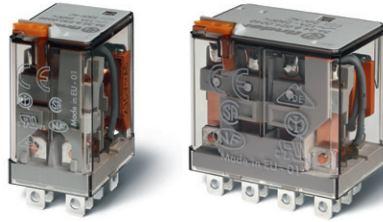

- 2 or 4 pole changeover contact
- Plug-in/Faston 187

**56.32-0300**



- 2 pole normally open contact ( $\geq 1.5$  mm gap)
- Plug-in/Faston 187

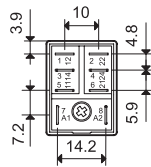
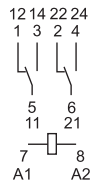

56.32

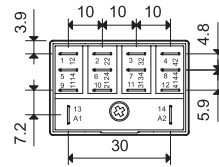
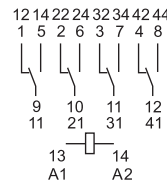

56.34

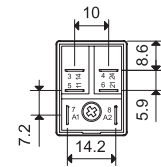
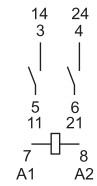

56.32-0300

\* For 4 CO (4PDT) only.

FOR UL RATINGS SEE:

"General technical information" page V

For outline drawing see page 8

**Contact specification**

Contact configuration		2 CO (DPDT)	4 CO (4PDT)	2NO (DPST-NO) - $\geq 1.5$ mm gap
Rated current/Maximum peak current	A	12/20		12/20
Rated voltage/ Maximum switching voltage	V AC	250/400		250/400
Rated load AC1	VA	3000		3000
Rated load AC15 (230 V AC)	VA	700		700
Single phase motor rating (230 V AC)	kW	0.55		0.55
Breaking capacity DC1: 30/110/220 V	A	12/0.5/0.25		12/1/0.5
Minimum switching load	mW (V/mA)	500 (10/5)		500 (10/5)
Standard contact material		AgNi		AgNi

**Coil specification**

Nominal voltage ( $U_N$ )	V AC (50/60 Hz)	6 - 12 - 24 - 48 - 60 - 110 - 120 - 230 - 240 - 400*		
	V DC	6 - 12 - 24 - 48 - 60 - 110 - 125 - 220		—
Rated power AC/DC	VA (50 Hz)/W	1.5/1	2/1.3	1.5/—
Operating range	AC	(0.8...1.1) $U_N$		(0.85...1.1) $U_N$
	DC	(0.8...1.1) $U_N$	(0.8...1.1) $U_N$	—
Holding voltage	AC/DC	0.8 $U_N$ / 0.6 $U_N$		0.85 $U_N$ / —
Must drop-out voltage	AC/DC	0.2 $U_N$ / 0.1 $U_N$		0.2 $U_N$ / —

**Technical data**

Mechanical life AC/DC	cycles	20 · 10 <sup>6</sup> / 50 · 10 <sup>6</sup>		20 · 10 <sup>6</sup> / —
Electrical life at rated load AC1	cycles	100 · 10 <sup>3</sup>		100 · 10 <sup>3</sup>
Operate/release time	ms	9/6	11/11	8/4
Insulation between coil and contacts (1.2/50 $\mu$ s)	kV	4	5	4
Dielectric strength between open contacts	V AC	1000		2000
Ambient temperature range	°C	-40...+70		-40...+70
Environmental protection		RT I		RT I

**Approvals** (according to type)



**Printed circuit mount**

**12 A Power relay**

- 2 & 4 pole
- AC coils & DC coils
- Cadmium Free contacts (standard version)
- Contact material option
- RT III (wash tight) option available

A

**56.42/56.44**



- 2 or 4 pole changeover contact
- PCB mount

**56.42-0300**



- 2 pole normally open contact ( $\geq 1.5$  mm gap)
- PCB mount

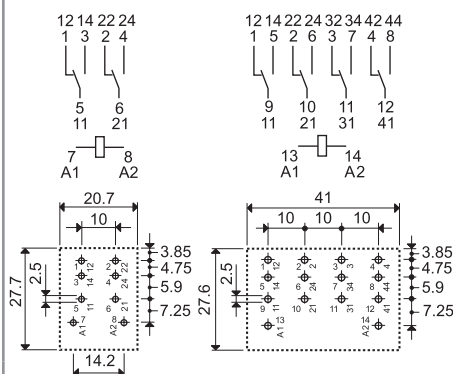

56.42  
Copper side view

56.44  
Copper side view

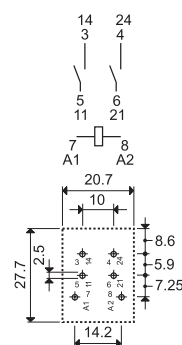

56.42-0300  
Copper side view

\* For 4 CO (4PDT) only.

FOR UL RATINGS SEE:

"General technical information" page V

For outline drawing see page 8

**Contact specification**

Contact configuration		2 CO (DPDT)	4 CO (4PDT)	2NO (DPST-NO) - $\geq 1.5$ mm gap
Rated current/Maximum peak current	A	12/20		12/20
Rated voltage/ Maximum switching voltage	V AC	250/400		250/400
Rated load AC1	VA	3000		3000
Rated load AC15 (230 V AC)	VA	700		700
Single phase motor rating (230 V AC)	kW	0.55		0.55
Breaking capacity DC1: 30/110/220 V	A	12/0.5/0.25		12/1/0.5
Minimum switching load	mW (V/mA)	500 (10/5)		500 (10/5)
Standard contact material		AgNi		AgNi

**Coil specification**

Nominal voltage ( $U_N$ )	V AC (50/60 Hz)	6 - 12 - 24 - 48 - 60 - 110 - 120 - 230 - 240 - 400*		
	V DC	6 - 12 - 24 - 48 - 60 - 110 - 125 - 220		—
Rated power AC/DC	VA (50 Hz)/W	1.5/1	2/1.3	1.5/—
Operating range	AC	(0.8...1.1) $U_N$		(0.85...1.1) $U_N$
	DC	(0.8...1.1) $U_N$	(0.8...1.1) $U_N$	—
Holding voltage	AC/DC	0.8 $U_N$ / 0.6 $U_N$		0.85 $U_N$ /—
Must drop-out voltage	AC/DC	0.2 $U_N$ / 0.1 $U_N$		0.2 $U_N$ /—

**Technical data**

Mechanical life AC/DC	cycles	20 · 10 <sup>6</sup> /50 · 10 <sup>6</sup>		20 · 10 <sup>6</sup> /—
Electrical life at rated load AC1	cycles	100 · 10 <sup>3</sup>		100 · 10 <sup>3</sup>
Operate/release time	ms	9/6	11/11	8/4
Insulation between coil and contacts (1.2/50 $\mu$ s)	kV	4	5	4
Dielectric strength between open contacts	V AC	1000		2000
Ambient temperature range	°C	-40...+70		-40...+70
Environmental protection		RT I		RT I

Approvals (according to type)



## Ordering information

Example: 56 series plug-in relay, 2 CO (DPDT), 12 V DC coil, lockable test button and mechanical indicator.

<p><b>Series</b> —————</p> <p><b>Type</b> ————— 3 = Plug-in 4 = PCB</p> <p><b>No. of poles</b> ————— 2 = 2 pole, 12 A 4 = 4 pole, 12 A</p> <p><b>Coil version</b> ————— 8 = AC (50/60 Hz) 9 = DC</p> <p><b>Coil voltage</b> ————— See coil specifications</p>	<p><b>5 6 . 3 2 . 9 . 0 1 2 . 0 0 4 0</b></p>	<p><b>A: Contact material</b> 0 = Standard AgNi 2 = AgCdO 4 = AgSnO<sub>2</sub></p> <p><b>B: Contact circuit</b> 0 = CO (nPDT) 3 = NO (nPST), ≥ 1.5 mm contact gap</p>	<p><b>D: Special versions</b> 0 = Standard 1 = Wash tight (RT III) for 56.42 and 56.44 only 6 = Rear flange mount (4 pole only) 8 = Rear 35 mm rail mount (4 pole only) For other mounting options see page 9</p> <p><b>C: Options</b> 0 = None 2 = Mechanical indicator 3* = LED (AC) 4 = Lockable test button + mechanical indicator 5* = Lockable test button + LED (AC) 54* = Lockable test button + LED (AC) + mechanical indicator 6* = Double LED (DC non-polarized) 7* = Lockable test button + double LED (DC non-polarized) 74* = Lockable test button + double LED (DC non-polarized) + mechanical indicator 8* = LED + diode (DC, polarity positive to pin 7) for 56.32 only 9* = Lockable test button + LED + diode (DC, polarity positive to pin 7) for 56.32 only 94* = Lockable test button + LED + diode (DC, polarity positive to pin 7) + mechanical indicator for 56.32 only</p> <p>* Options not available for 220 V DC and 400 V AC versions.</p>
---	---	--	---

### Selecting features and options: only combinations in the same row are possible.

Preferred selections for best availability are shown in **bold**.

Type	Coil version	A	B	C	D
56.32	AC	<b>0 - 2 - 4</b>	<b>0</b>	0 - 2 - 3 - <b>4</b> - 5	<b>0</b>
	AC	0 - 2 - 4	0	54	/
	AC	0 - 2 - 4	3	0 - 3 - 5	0
	DC	<b>0 - 2 - 4</b>	<b>0</b>	0 - 2 - <b>4</b> - 6 - 7 - 8 - 9	<b>0</b>
	DC	0 - 2 - 4	0	<b>74 - 94</b>	/
56.34	AC	<b>0 - 2 - 4</b>	<b>0</b>	<b>0 - 2 - 3 - 4 - 5</b>	<b>0 - 6 - 8</b>
	AC	0 - 2 - 4	0	54	/
	DC	<b>0 - 2 - 4</b>	<b>0</b>	<b>0 - 2 - 4 - 6 - 7</b>	<b>0 - 6 - 8</b>
	DC	0 - 2 - 4	0	<b>74</b>	/
56.42	DC	<b>0 - 2 - 4</b>	<b>0</b>	<b>0</b>	<b>0 - 1</b>
	AC	0 - 2 - 4	0 - 3	0	0 - 1
56.44	AC - DC	<b>0 - 2 - 4</b>	<b>0</b>	<b>0</b>	<b>0 - 1</b>

**Special versions for Rail Applications on request**

### Descriptions: options and special versions

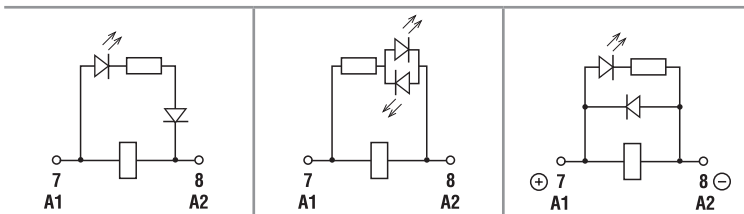

**C: Option 3, 5, 54**  
LED (AC)

**C: Option 6, 7, 74**  
Double LED  
(DC non-polarized)

**C: Option 8, 9, 94**  
LED + diode (DC, polarity positive to pin 7) - (56.32 only)

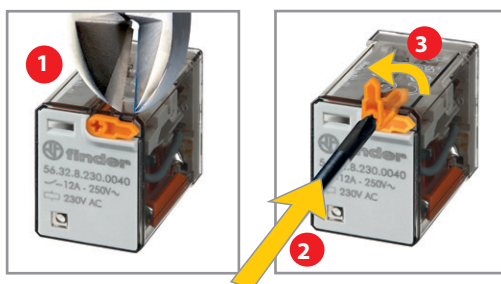

### Lockable test button and mechanical flag indicator (0040, 0050, 0054, 0070, 0074, 0090, 0094)

The dual-purpose Finder test button can be used in two ways:

**Case 1)** The plastic pip (located directly above the test button) remains intact. In this case, when the test button is pushed, the contacts operate. When the test button is released the contacts return to their former state.

**Case 2)** The plastic pip is broken-off (using an appropriate cutting tool). In this case, (in addition to the above function), when the test button is pushed and rotated, the contacts are latched in the operating state, and remain so until the test button is rotated back to its former position.

In both cases ensure that the test button actuation is swift and decisive.

**Technical data**

\* Only in applications where over voltage category II is permitted. In applications of over voltage category III: Micro-disconnection.

Insulation according to EN 61810-1		2 CO - 4 CO		2 NO	
Nominal voltage of supply system	V AC	230/400		230/400	
Rated insulation voltage	V AC	250	400	250	400
Pollution degree		3	2	3	2
<b>Insulation between coil and contact set</b>					
Type of Insulation		Basic		Basic	
Overvoltage category		III		III	
Rated impulse voltage	kV (1.2/50 μs)	4		4	
Dielectric strength	V AC	2500		2500	
<b>Insulation between adjacent contacts</b>					
Type of insulation		Basic		Basic	
Overvoltage category		III		III	
Rated impulse voltage	kV (1.2/50 μs)	4		4	
Dielectric strength	V AC	2500		2500	
<b>Insulation between open contacts</b>					
Type of disconnection		Micro-disconnection		Full-disconnection*	
Overvoltage category		—		II	
Rated impulse voltage	kV (1.2/50 μs)	—		2.5	
Dielectric strength	V AC/kV (1.2/50 μs)	1000/1.5		2000/3	
<b>Insulation between coil terminals</b>					
Rated impulse voltage (surge) differential mode (according to EN 61000-4-5)	kV(1.2/50 μs)	4			
<b>Other data</b>					
Bounce time: NO/NC	ms	1/4 (2 CO) , 1/7 (4 CO)		3/— (normally open)	
Vibration resistance (5...55)Hz: NO/NC	g	17/14			
Shock resistance	g	20/14			
Power lost to the environment	without contact current	W	1 (56.32, 56.42)		1.3 (56.34, 56.44)
	with rated current	W	3.8 (56.32, 56.42)		6.9 (56.34, 56.44)
Recommended distance between relays mounted on PCB	mm	≥ 5			

**Contact specification**

**F 56 - Electrical life (AC) v contact current**

2 - 4 pole relays

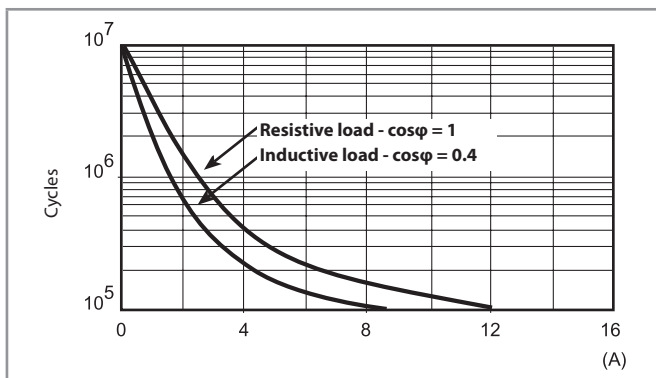

**H 56 - Maximum DC1 breaking capacity**

Changeover version

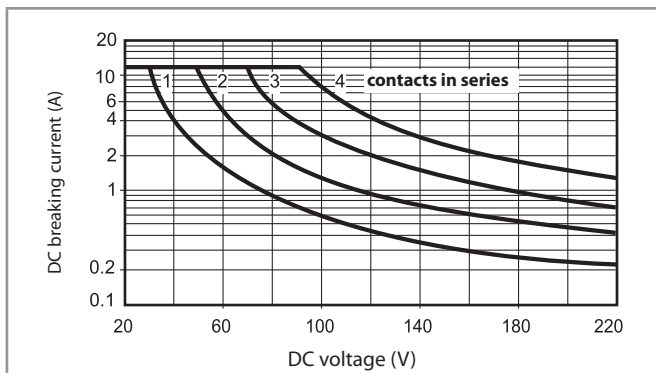

**H 56 - Maximum DC1 breaking capacity**

Normally open version

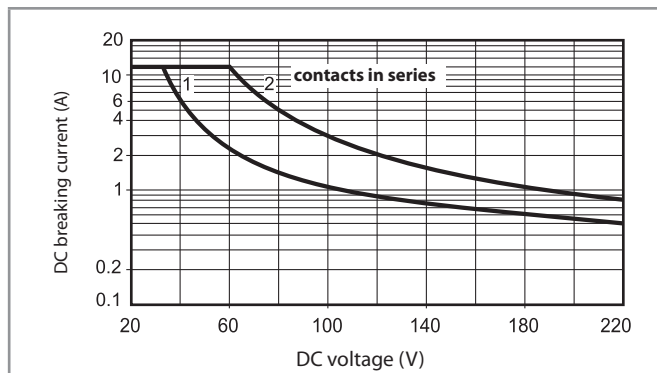

- When switching a resistive load (DC1) having voltage and current values under the curve, an electrical life of  $\geq 100 \cdot 10^3$  can be expected.
- In the case of DC13 loads, the connection of a diode in parallel with the load will permit a similar electrical life as for a DC1 load.

Note: the release time of the load will be increased.

## Coil specifications

**DC coil data, 2 pole relay**

Nominal voltage $U_N$	Coil code	Operating range		Resistance $R$	Rated coil consumption $I$ at $U_N$
		$U_{min}$	$U_{max}$		
V		V	V	$\Omega$	mA
6	9.006	4.8	6.6	40	150
12	9.012	9.6	13.2	140	86
24	9.024	19.2	26.4	600	40
48	9.048	38.4	52.8	2400	20
60	9.060	48	66	4000	15
110	9.110	88	121	12500	8.8
125	9.125	100	138	17300	7.2
220	9.220	176	242	54000	4

**AC coil data, 2 pole relay**

Nominal voltage $U_N$	Coil code	Operating range		Resistance $R$	Rated coil consumption $I$ at $U_N$ (50 Hz)
		$U_{min}^*$	$U_{max}$		
V		V	V	$\Omega$	mA
6	8.006	4.8	6.6	12	200
12	8.012	9.6	13.2	50	97
24	8.024	19.2	26.4	190	53
48	8.048	38.4	52.8	770	25
60	8.060	48	66	1200	21
110	8.110	88	121	3940	12.5
120	8.120	96	132	4700	12
230	8.230	184	253	17000	6
240	8.240	192	264	19100	5.3

\*  $U_{min} = 0.85 U_N$  for normally open version.

**DC coil data, 4 pole relay**

Nominal voltage $U_N$	Coil code	Operating range		Resistance $R$	Rated coil consumption $I$ at $U_N$
		$U_{min}$	$U_{max}$		
V		V	V	$\Omega$	mA
6	9.006	4.8	6.6	32.5	185
12	9.012	9.6	13.2	123	97
24	9.024	19.2	26.4	490	49
48	9.048	38.4	52.8	1800	27
60	9.060	48	66	3000	20
110	9.110	88	121	10400	10.5
125	9.125	100	138	14200	8.8
220	9.220	176	242	44000	5

**AC coil data, 4 pole relay**

Nominal voltage $U_N$	Coil code	Operating range		Resistance $R$	Rated coil consumption $I$ at $U_N$ (50 Hz)
		$U_{min}$	$U_{max}$		
V		V	V	$\Omega$	mA
6	8.006	4.8	6.6	5.7	300
12	8.012	9.6	13.2	22	150
24	8.024	19.2	26.4	81	90
48	8.048	38.4	52.8	380	37
60	8.060	48	66	600	30
110	8.110	88	121	1900	16.5
120	8.120	96	132	2560	13.4
230	8.230	184	253	7700	9
240	8.240	192	264	10000	7.5
400	8.400	320	440	26000	4.9

**R 56 - DC coil operating range v ambient temperature**  
2 and 4 pole relay

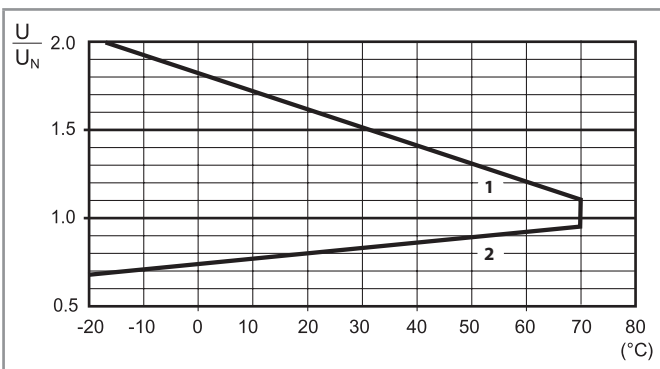

- 1 - Max. permitted coil voltage.
- 2 - Min. pick-up voltage with coil at ambient temperature.

**R 56 - AC coil operating range v ambient temperature**  
2 pole relay

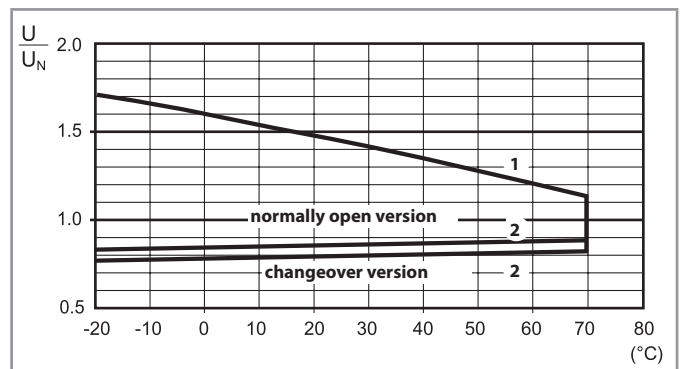

**R 56 - AC coil operating range v ambient temperature**  
4 pole relay

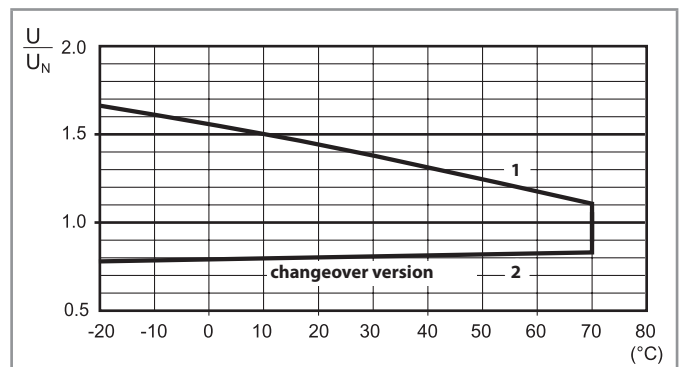

- 1 - Max. permitted coil voltage.
- 2 - Min. pick-up voltage with coil at ambient temperature.

## Outline drawings

Types 56.32/32-0300

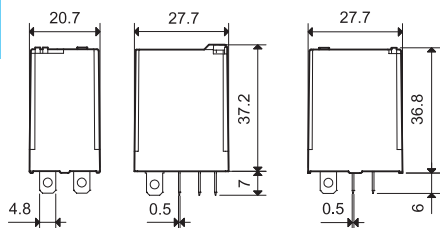

Type 56.34

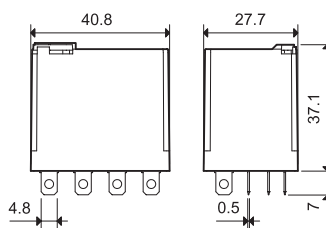

Types 56.42/42-0300

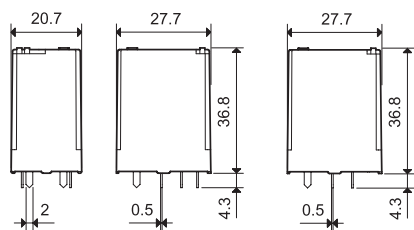

Type 56.44

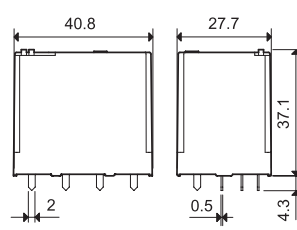



**Accessories**



**056.25**



**056.25 with relay**

**Top flange mount adaptor for 56.32**

**056.25**

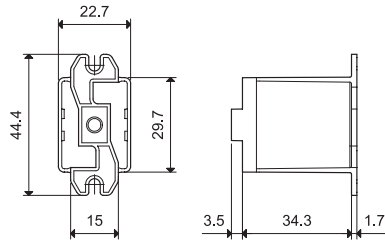

056.25

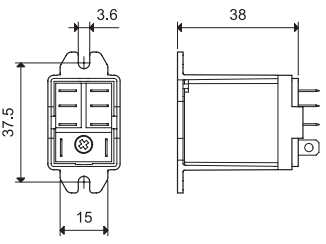

056.25 with relay



**056.26**



**056.26 with relay**

**Rear flange mount adaptor for 56.32**

**056.26**

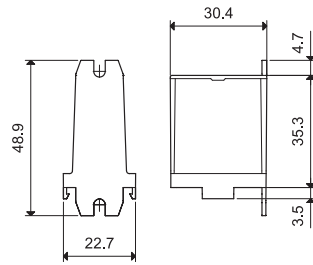

056.26

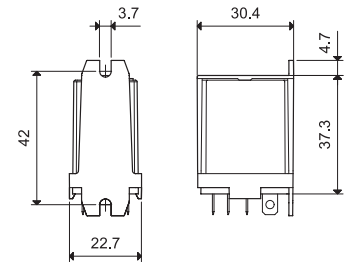

056.26 with relay



**056.27**



**056.27 with relay**

**Top 35 mm rail (EN 60715) adaptor for 56.32**

**056.27**

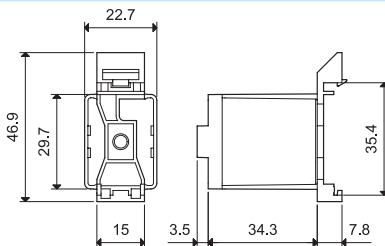

056.27

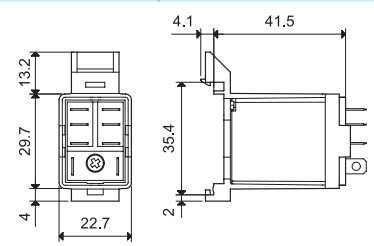

056.27 with relay



**056.45**



**056.45 with relay**

**Top flange mount adaptor for 56.34**

**056.45**

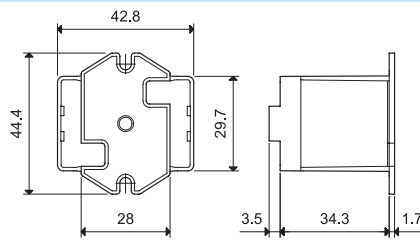

056.45

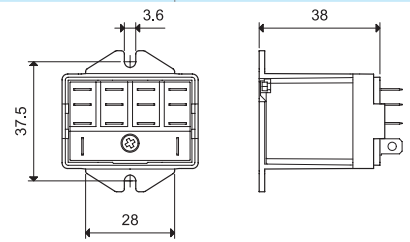

056.45 with relay



**056.47**



**056.47 with relay**

**Top 35 mm rail (EN 60715) adaptor for 56.34**

**056.47**

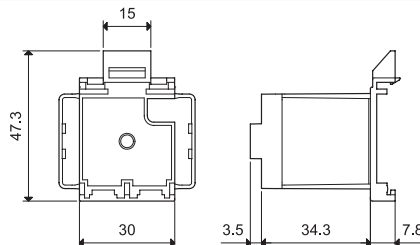

056.47

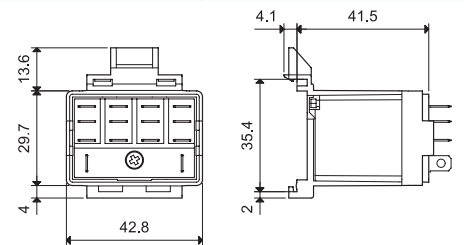

056.47 with relay

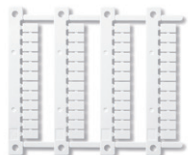

**060.48**

**Sheet of marker tags** for relay type 56.34, plastic, 48 tags, 6 x 12 mm, for CEMBRE thermal transfer printers

**060.48**

A



**96.02**  
Approvals  
(according to type):



**96.04**  
Approvals  
(according to type):



**094.91.3**

Screw terminal (Box clamp) socket panel or 35 mm rail mount (EN 60715)	96.02 Blue	96.02.0 Black	96.04 Blue	96.04.0 Black
For relay type	56.32		56.34	
<b>Accessories</b>				
Metal retaining clip (supplied with socket - packaging code SMA)	094.71		096.71	
Plastic retaining and release clip (supplied with socket - packaging code SPA)	094.91.3	094.91.30	—	—
6-way jumper link	094.06	094.06.0	—	—
Identification tag	095.00.4		090.00.2	
Modules (see table below)	99.02			
Timer modules (see table below)	86.30		86.00, 86.30	
Sheet of marker tags for retaining and release clip 094.91.3, plastic, 48 tags, 6 x 12 mm, for CEMBRE thermal transfer printers	060.48		—	
<b>Technical data</b>				
Rated values	12 A - 250 V			
Dielectric strength	2 kV AC			
Protection category	IP 20			
Ambient temperature	°C -40...+70 (see diagram L96)			
⊕ Screw torque	Nm	0.8		
Wire strip length	mm	8		
Max. wire size for 94.02/04 sockets		solid wire	stranded wire	
	mm <sup>2</sup>	1 x 6 / 2 x 2.5		1 x 4 / 2 x 2.5
	AWG	1 x 10 / 2 x 14		1 x 12 / 2 x 14

L 96 - Rated current v ambient temperature

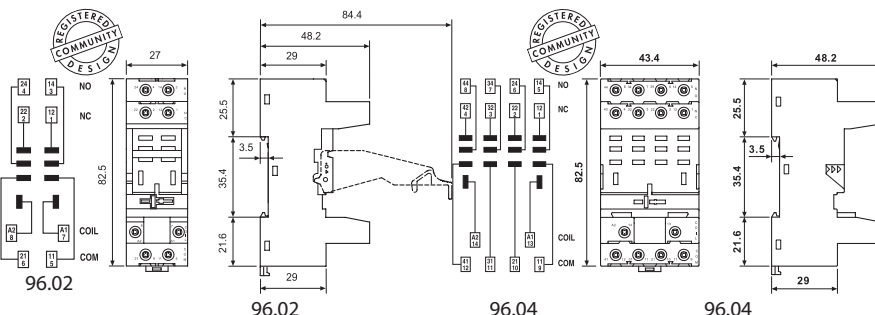
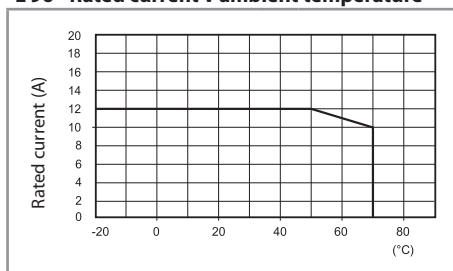

**094.06**



**86.00**



**86.30**



**99.02**

Approvals  
(according to type):



DC Modules with non-standard polarity (+A2) on request.

6-way jumper link for 96.02 socket	094.06 (blue)	094.06.0 (black)
Rated values	10 A - 250 V	

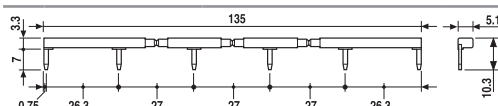

<b>86 series timer modules</b>		
Multi-voltage: (12...240)V AC/DC;		
Multi-functions: AI, DI, SW, BE, CE, DE, EE, FE; (0.05 s... 100 h)		86.00.0.240.0000
(12...24)V AC/DC; Bi-function: AI, DI; (0.05 s... 100 h)		86.30.0.024.0000
(110...125)V AC; Bi-function: AI, DI; (0.05 s... 100 h)		86.30.8.120.0000
(230...240)V AC; Bi-function: AI, DI; (0.05 s... 100 h)		86.30.8.240.0000

Approvals (according to type): **CE EAC cRU US**

<b>99.02 coil indication and EMC suppression modules for 96.02 and 96.04 sockets</b>		
Diode (+A1, standard polarity)	(6...220)V DC	99.02.3.000.00
LED	(6...24)V DC/AC	99.02.0.024.59
LED	(28...60)V DC/AC	99.02.0.060.59
LED	(110...240)V DC/AC	99.02.0.230.59
LED + Diode (+A1, standard polarity)	(6...24)V DC	99.02.9.024.99
LED + Diode (+A1, standard polarity)	(28...60)V DC	99.02.9.060.99
LED + Diode (+A1, standard polarity)	(110...220)V DC	99.02.9.220.99
LED + Varistor	(6...24)V DC/AC	99.02.0.024.98
LED + Varistor	(28...60)V DC/AC	99.02.0.060.98
LED + Varistor	(110...240)V DC/AC	99.02.0.230.98
RC circuit	(6...24)V DC/AC	99.02.0.024.09
RC circuit	(28...60)V DC/AC	99.02.0.060.09
RC circuit	(110...240)V DC/AC	99.02.0.230.09
Residual current by-pass	(110...240)V AC	99.02.8.230.07

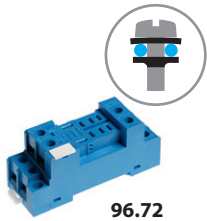

96.72

Approvals  
(according to type):

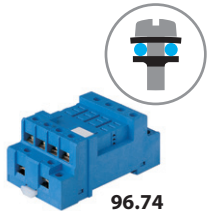

96.74

Approvals  
(according to type):



<b>Screw terminal (Plate clamp) socket</b> panel or 35 mm rail (EN 60715) mount	<b>96.72</b> <b>Blue</b>	<b>96.72.0</b> <b>Black</b>	<b>96.74</b> <b>Blue</b>	<b>96.74.0</b> <b>Black</b>
For relay type	56.32		56.34	
<b>Accessories</b>				
Metal retaining clip (supplied with socket - packaging code SMA)	094.71		096.71	
Modules (see table below)	99.01			
<b>Technical data</b>				
Rated values	12 A - 250 V			
Dielectric strength	2 kV AC			
Protection category	IP 20			
Ambient temperature	°C	-40...+70		
Screw torque	Nm	0.8		
Wire strip length	mm	10		
Max. wire size for 96.72 and 96.74 sockets		solid wire	stranded wire	
	mm <sup>2</sup>	1 x 4 / 2 x 4	1 x 4 / 2 x 2.5	
	AWG	1 x 12 / 2 x 12	1 x 12 / 2 x 14	

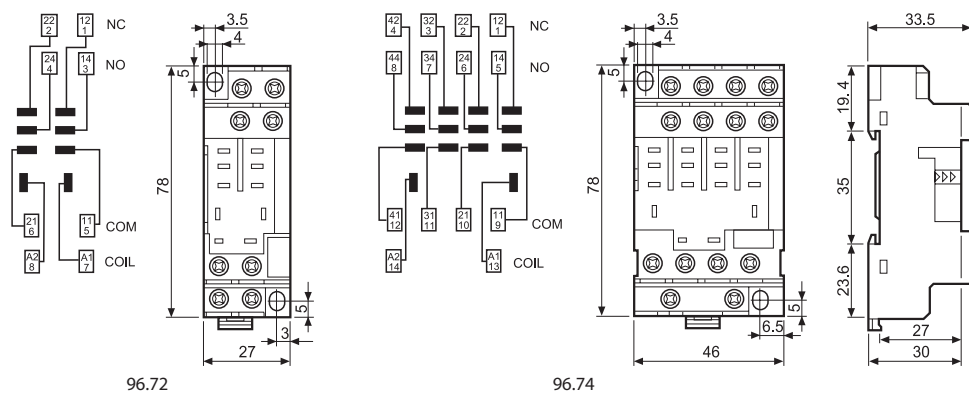

99.01

Approvals  
(according to type):



\* Modules in Black housing are available on request.  
Green LED is standard.  
Red LED available on request.

99.01 coil indication and EMC suppression modules for types 96.72 and 96.74 sockets		Blue*
Diode (+A1, standard polarity)	(6...220)V DC	99.01.3.000.00
Diode (+A2, non-standard polarity)	(6...220)V DC	99.01.2.000.00
LED	(6...24)V DC/AC	99.01.0.024.59
LED	(28...60)V DC/AC	99.01.0.060.59
LED	(110...240)V DC/AC	99.01.0.230.59
LED + Diode (+A1, standard polarity)	(6...24)V DC	99.01.9.024.99
LED + Diode (+A1, standard polarity)	(28...60)V DC	99.01.9.060.99
LED + Diode (+A1, standard polarity)	(110...220)V DC	99.01.9.220.99
LED + Diode (+A2, non-standard polarity)	(6...24)V DC	99.01.9.024.79
LED + Diode (+A2, non-standard polarity)	(28...60)V DC	99.01.9.060.79
LED + Diode (+A2, non-standard polarity)	(110...220)V DC	99.01.9.220.79
LED + Varistor	(6...24)V DC/AC	99.01.0.024.98
LED + Varistor	(28...60)V DC/AC	99.01.0.060.98
LED + Varistor	(110...240)V DC/AC	99.01.0.230.98
RC circuit	(6...24)V DC/AC	99.01.0.024.09
RC circuit	(28...60)V DC/AC	99.01.0.060.09
RC circuit	(110...240)V DC/AC	99.01.0.230.09
Residual current by-pass	(110...240)V AC	99.01.8.230.07



96.12

A

Approvals  
(according to type):



PCB socket	96.12 (blue)	96.12.0 (blue)	96.14 (blue)	96.14.0 (blue)
For relay type	56.32		56.34	
<b>Accessories</b>	094.51			
<b>Technical data</b>				
Rated values	15 A - 250 V			
Dielectric strength	2 kV AC			
Protection category	IP 20			
Ambient temperature	°C -40...+70			

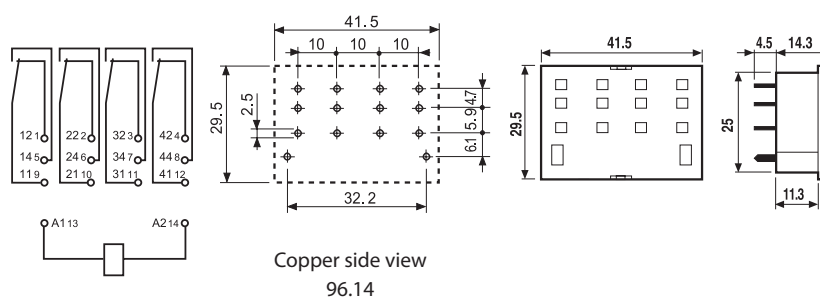
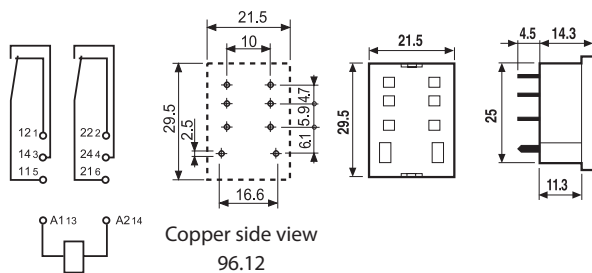

## Packaging codes

How to code and identify retaining clip and packaging options for sockets.

Example:

