

EVALUATION KIT  
AVAILABLE



# 6W, Filterless, Spread-Spectrum Mono/Stereo Class D Amplifiers

## General Description

The MAX9713/MAX9714 mono/stereo Class D audio power amplifiers provide Class AB amplifier performance with Class D efficiency, conserving board space and eliminating the need for a bulky heatsink. Using a Class D architecture, these devices deliver up to 6W while offering greater than 85% efficiency. Proprietary and protected modulation and switching schemes render the traditional Class D output filter unnecessary.

The MAX9713/MAX9714 offer two modulation schemes: a fixed-frequency mode (FFM), and a spread-spectrum mode (SSM) that reduces EMI-radiated emissions due to the modulation frequency. The device utilizes a fully differential architecture, a full bridged output, and comprehensive click-and-pop suppression.

The MAX9713/MAX9714 feature high 76dB PSRR, low 0.07% THD+N, and SNR in excess of 95dB. Short-circuit and thermal-overload protection prevent the devices from being damaged during a fault condition. The MAX9713 is available in a 32-pin TQFN (5mm x 5mm x 0.8mm) package. The MAX9714 is available in a 32-pin TQFN (7mm x 7mm x 0.8mm) package. Both devices are specified over the extended -40°C to +85°C temperature range.

## Applications

LCD Monitors  
LCD TVs  
Desktop PCs  
LCD Projectors

High-End Notebook Audio  
Hands-Free Car Phone Adaptors

## Features

- ◆ Filterless Class D Amplifier
- ◆ Unique Spread-Spectrum Mode Offers 5dB Emissions Improvement Over Conventional Methods
- ◆ Up to 85% Efficient
- ◆ 6W Output Power into 8Ω
- ◆ Low 0.07% THD+N
- ◆ High PSRR (76dB at 1kHz)
- ◆ 10V to 25V Single-Supply Operation
- ◆ Differential Inputs Minimize Common-Mode Noise
- ◆ Pin-Selectable Gain Reduces Component Count
- ◆ Industry-Leading Integrated Click-and-Pop Suppression
- ◆ Low Quiescent Current (18mA)
- ◆ Low-Power Shutdown Mode (0.2μA)
- ◆ Short-Circuit and Thermal-Overload Protection
- ◆ Available in Thermally Efficient, Space-Saving Packages

32-Pin TQFN (5mm x 5mm x 0.8mm)—MAX9713

32-Pin TQFN (7mm x 7mm x 0.8mm)—MAX9714

## Ordering Information

| PART        | TEMP RANGE     | PIN-PACKAGE | AMP    |
|-------------|----------------|-------------|--------|
| MAX9713ETJ+ | -40°C to +85°C | 32 TQFN-EP* | Mono   |
| MAX9714ETJ+ | -40°C to +85°C | 32 TQFN-EP* | Stereo |

\*EP = Exposed paddle.

+Denotes lead-free package.

## Block Diagrams

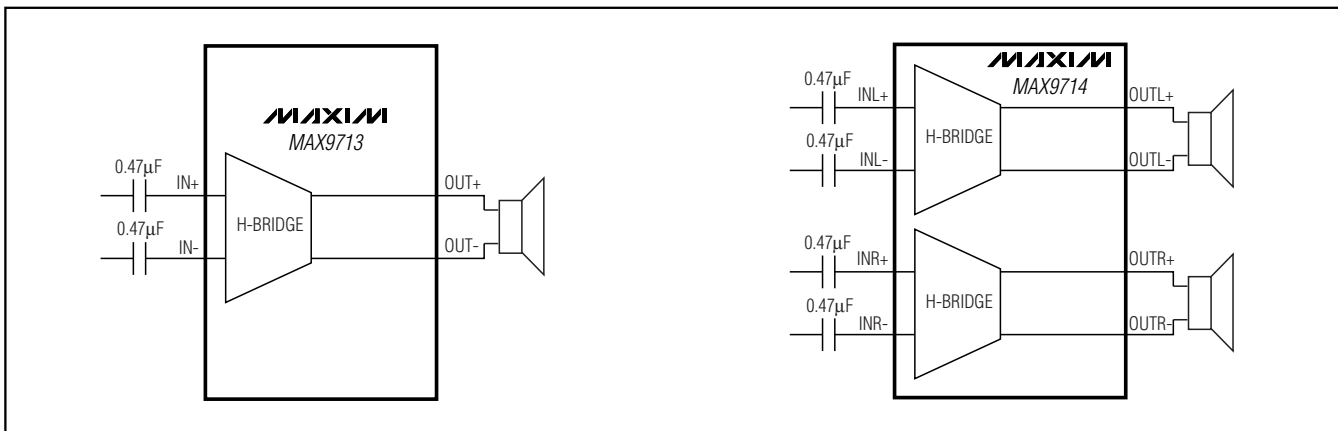

Pin Configurations appear at end of data sheet.



Maxim Integrated Products 1

For pricing, delivery, and ordering information, please contact Maxim/Dallas Direct! at 1-888-629-4642, or visit Maxim's website at [www.maxim-ic.com](http://www.maxim-ic.com).

MAX9713/MAX9714

# 6W, Filterless, Spread-Spectrum Mono/Stereo Class D Amplifiers

## ABSOLUTE MAXIMUM RATINGS

(All voltages referenced to GND.)

|   |  |
|---|--|
| V <sub>DD</sub> to PGND, AGND   | 30V  |
| OUTR <sub>-</sub> , OUTL <sub>-</sub> , C1N   | -0.3V to (V <sub>DD</sub> + 0.3V)          |
| C1P   | (V <sub>DD</sub> - 0.3V) to (CHOLD + 0.3V) |
| CHOLD   | (V <sub>DD</sub> - 0.3V) to +40V           |
| All Other Pins to GND   | -0.3V to +12V                              |
| Duration of OUTR <sub>-</sub> /OUTL <sub>-</sub><br>Short Circuit to GND, V <sub>DD</sub> | Continuous                                 |
| Continuous Input Current (V <sub>DD</sub> , PGND, AGND)                                   | 1.6A                                       |
| Continuous Input Current (all other pins)   | ±20mA                                      |

Continuous Power Dissipation (T<sub>A</sub> = +70°C)

Single-Layer Board:

|  |          |
|--|----------|
| MAX9713 32-Pin TQFN (derate 21.3mW/°C above +70°C) | 1702.1mW |
| MAX9714 32-Pin TQFN (derate 27mW/°C above +70°C)   | 2162.2mW |

Multilayer Board:

|  |          |
|--|----------|
| MAX9713 32-Pin TQFN (derate 34.5mW/°C above +70°C) | 2758.6mW |
| MAX9714 32-Pin TQFN (derate 37mW/°C above +70°C)   | 2963.0mW |

Junction Temperature

Operating Temperature Range

Storage Temperature Range

Lead Temperature (soldering, 10s)

Stresses beyond those listed under "Absolute Maximum Ratings" may cause permanent damage to the device. These are stress ratings only, and functional operation of the device at these or any other conditions beyond those indicated in the operational sections of the specifications is not implied. Exposure to absolute maximum rating conditions for extended periods may affect device reliability.

## ELECTRICAL CHARACTERISTICS

(V<sub>DD</sub> = 15V, GND = PGND = 0V,  $\overline{\text{SHDN}} \geq V_{IH}$ , A<sub>v</sub> = 16dB, C<sub>SS</sub> = C<sub>IN</sub> = 0.47μF, C<sub>REG</sub> = 0.01μF, C1 = 100nF, C2 = 1μF, FS1 = FS2 = GND (f<sub>S</sub> = 330kHz), R<sub>L</sub> connected between OUTL+ and OUTL- and OUTR+ and OUTR-, T<sub>A</sub> = T<sub>MIN</sub> to T<sub>MAX</sub>, unless otherwise noted. Typical values are at T<sub>A</sub> = +25°C.) (Notes 1, 2)

| PARAMETER                               | SYMBOL            | CONDITIONS                             | MIN                         | TYP  | MAX  | UNITS |  |
|---|-------------------|--|-----------------------------|------|------|-------|--|
| <b>GENERAL</b>                          |                   |  |                             |      |      |       |  |
| Supply Voltage Range                    | V <sub>DD</sub>   | Inferred from PSRR test                | 10                          |      | 25   | V     |  |
| Quiescent Current                       | I <sub>DD</sub>   | R <sub>L</sub> = ∞                     | MAX9713                     | 10   | 17.5 | mA    |  |
|   |                   |  | MAX9714                     | 18   | 23   |       |  |
| Shutdown Current                        | I <sub>SHDN</sub> |  |                             | 0.2  | 1.5  | μA    |  |
| Turn-On Time                            | t <sub>ON</sub>   | C <sub>SS</sub> = 470nF                |                             | 100  |      | ms    |  |
|   |                   | C <sub>SS</sub> = 180nF                |                             | 50   |      |       |  |
| Amplifier Output Resistance in Shutdown |                   | $\overline{\text{SHDN}} = \text{GND}$  | 150                         | 330  |      | kΩ    |  |
| Input Impedance                         | R <sub>IN</sub>   | A <sub>v</sub> = 13dB                  | 35                          | 58   | 80   | kΩ    |  |
|   |                   | A <sub>v</sub> = 16dB                  | 30                          | 48   | 65   |       |  |
|   |                   | A <sub>v</sub> = 19.1dB                | 23                          | 39   | 55   |       |  |
|   |                   | A <sub>v</sub> = 22.1dB                | 20                          | 31   | 42   |       |  |
| Voltage Gain                            | A <sub>v</sub>    | G1 = L, G2 = L                         | 21.9                        | 22.1 | 22.3 | dB    |  |
|   |                   | G1 = L, G2 = H                         | 18.9                        | 19.1 | 19.3 |       |  |
|   |                   | G1 = H, G2 = L                         | 12.8                        | 13   | 13.2 |       |  |
|   |                   | G1 = H, G2 = H                         | 15.9                        | 16   | 16.3 |       |  |
| Gain Matching                           |                   | Between channels (MAX9714)             |                             | 0.5  |      | %     |  |
| Output Offset Voltage                   | V <sub>OS</sub>   |  |                             | ±6   | ±30  | mV    |  |
| Common-Mode Rejection Ratio             | CMRR              | f <sub>IN</sub> = 1kHz, input referred |                             | 60   |      | dB    |  |
| Power-Supply Rejection Ratio (Note 3)   | PSRR              | V <sub>DD</sub> = 10V to 25V           | 54                          | 76   |      | dB    |  |
|   |                   | 200mV <sub>P-P</sub> ripple            | f <sub>RIPPLE</sub> = 1kHz  |      | 76   |       |  |
|   |                   |  | f <sub>RIPPLE</sub> = 20kHz |      | 60   |       |  |

# 6W, Filterless, Spread-Spectrum Mono/Stereo Class D Amplifiers

MAX9713/MAX9714

## ELECTRICAL CHARACTERISTICS (continued)

( $V_{DD} = 15V$ ,  $GND = PGND = 0V$ ,  $\overline{SHDN} \geq V_{IH}$ ,  $A_V = 16dB$ ,  $C_{SS} = C_{IN} = 0.47\mu F$ ,  $C_{REG} = 0.01\mu F$ ,  $C_1 = 100nF$ ,  $C_2 = 1\mu F$ ,  $FS1 = FS2 = GND$  ( $f_S = 330kHz$ ),  $R_L$  connected between  $OUTL+$  and  $OUTL-$  and  $OUTR+$  and  $OUTR-$ ,  $T_A = T_{MIN}$  to  $T_{MAX}$ , unless otherwise noted. Typical values are at  $T_A = +25^\circ C$ .) (Notes 1, 2)

| PARAMETER   | SYMBOL    | CONDITIONS   |                       | MIN     | TYP  | MAX | UNITS   |
|---|-----------|--|-----------------------|---------|------|-----|---------|
| Output Power  | $P_{OUT}$ | THD+N = 10%,<br>$f = 1kHz$   | $R_L = 16\Omega$      |         | 8    |     | W       |
|   |           |  | $R_L = 8\Omega$       |         | 6    |     |         |
| Total Harmonic Distortion Plus Noise  | THD+N     | $f_{IN} = 1kHz$ , either FFM or SSM, $R_L = 8\Omega$ ,<br>$P_{OUT} = 4W$ |                       |         | 0.07 |     | %       |
| Signal-to-Noise Ratio   | SNR       | $R_L = 8\Omega$ , $P_{OUT} = 4W$ , $f = 1kHz$                            | BW = 22Hz to<br>22kHz | FFM     | 94   |     | dB      |
|   |           |  |                       | SSM     | 88   |     |         |
|   |           |  | A-weighted            | FFM     | 97   |     |         |
|   |           |  |                       | SSM     | 91   |     |         |
| Oscillator Frequency  | $f_{OSC}$ | FS1 = L, FS2 = L   |                       | 300     | 335  | 370 | kHz     |
|   |           | FS1 = L, FS2 = H   |                       | 460     |      |     |         |
|   |           | FS1 = H, FS2 = L   |                       | 236     |      |     |         |
|   |           | FS1 = H, FS2 = H (spread-spectrum mode)                                  |                       | 335     |      |     |         |
| Efficiency  | $\eta$    | $P_{OUT} = 5W$ , $f_{IN} = 1kHz$ , $R_L = 16\Omega$                      |                       | 85      |      |     | %       |
|   |           | $P_{OUT} = 4W$ , $f = 1kHz$ , $R_L = 8\Omega$                            |                       | 75      |      |     |         |
| <b>DIGITAL INPUTS (<math>\overline{SHDN}</math>, <math>FS_{-}</math>, <math>G_{-}</math>)</b> |           |  |                       |         |      |     |         |
| Input Thresholds  |           | $V_{IH}$   |                       | 2.5     |      |     | V       |
|   |           | $V_{IL}$   |                       | 0.8     |      |     |         |
| Input Leakage Current   |           |  |                       | $\pm 1$ |      |     | $\mu A$ |

**Note 1:** All devices are 100% production tested at  $+25^\circ C$ . All temperature limits are guaranteed by design.

**Note 2:** Testing performed with a resistive load in series with an inductor to simulate an actual speaker load. For  $R_L = 8\Omega$ ,  $L = 68\mu H$ . For  $R_L = 16\Omega$ ,  $L = 136\mu H$ .

**Note 3:** PSRR is specified with the amplifier inputs connected to GND through  $C_{IN}$ .

# 6W, Filterless, Spread-Spectrum Mono/Stereo Class D Amplifiers

## Typical Operating Characteristics

(136 $\mu$ H with 16 $\Omega$ , 68 $\mu$ H with 8 $\Omega$ , part in SSM mode, unless otherwise noted.)

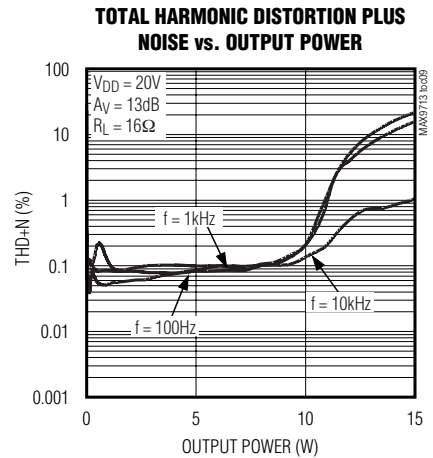
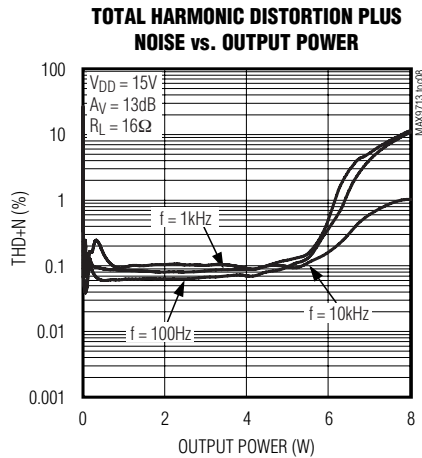
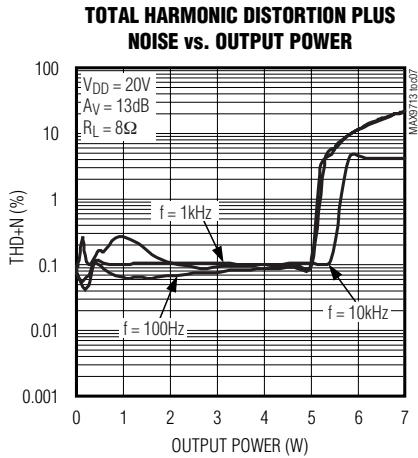
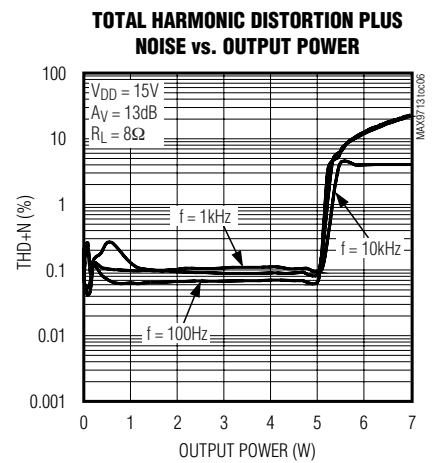
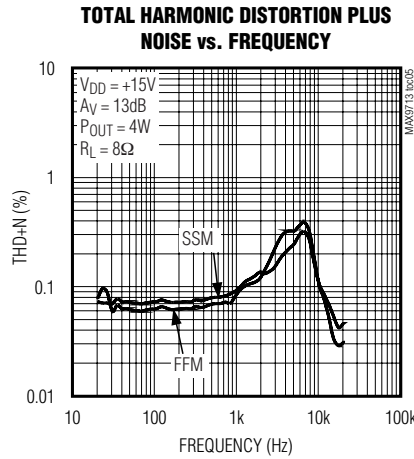
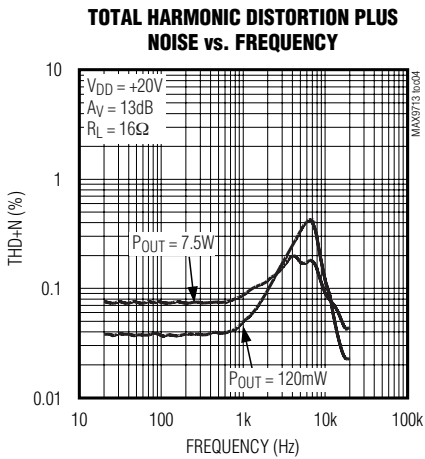
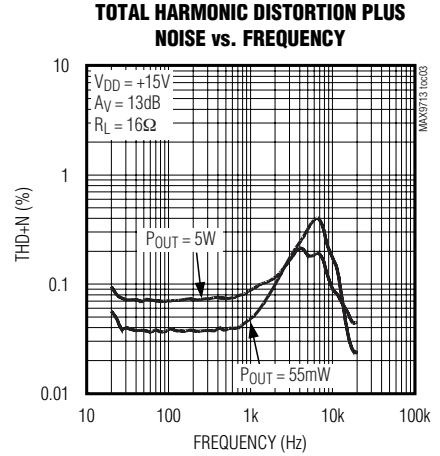
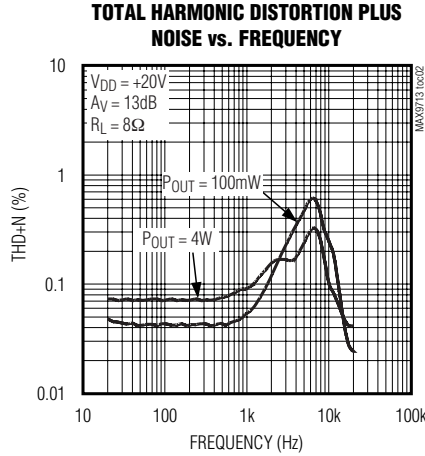
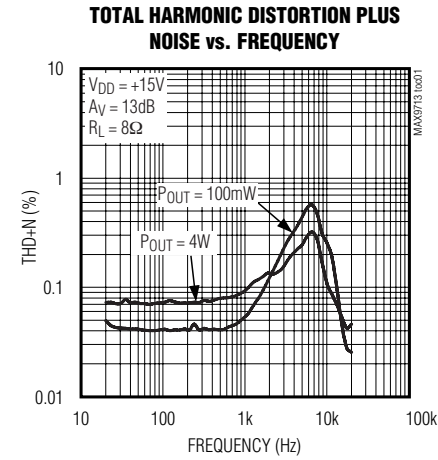

# 6W, Filterless, Spread-Spectrum Mono/Stereo Class D Amplifiers

## Typical Operating Characteristics (continued)

(136 $\mu$ H with 16 $\Omega$ , 68 $\mu$ H with 8 $\Omega$ , part in SSM mode, unless otherwise noted.)

MAX9713/MAX9714

**TOTAL HARMONIC DISTORTION PLUS NOISE vs. OUTPUT POWER**

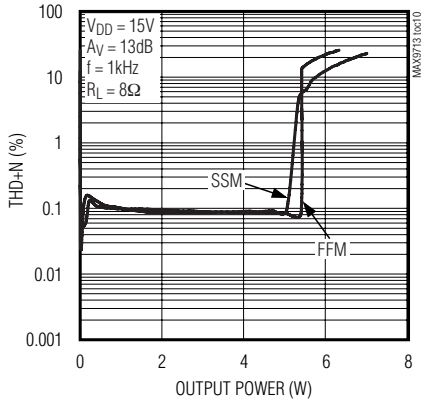

**EFFICIENCY vs. OUTPUT POWER**

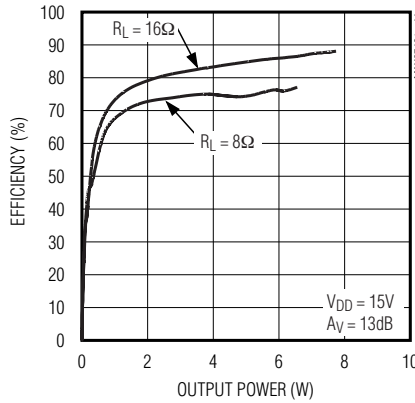

**EFFICIENCY vs. OUTPUT POWER**

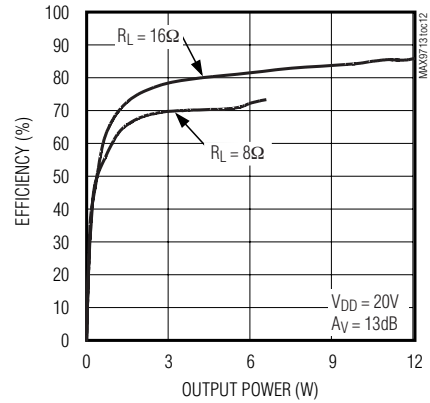

**OUTPUT POWER vs. SUPPLY VOLTAGE**

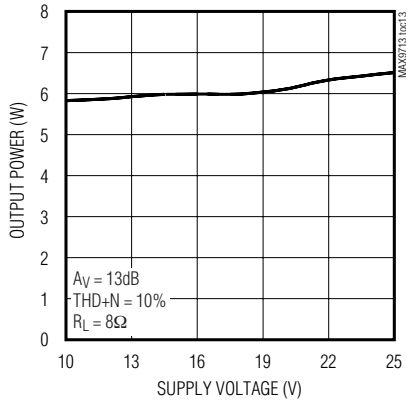

**OUTPUT POWER vs. LOAD RESISTANCE**

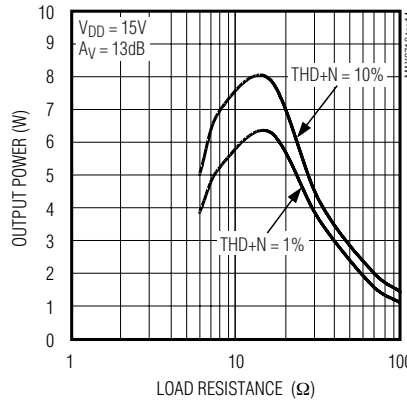

**COMMON-MODE REJECTION RATIO vs. FREQUENCY**

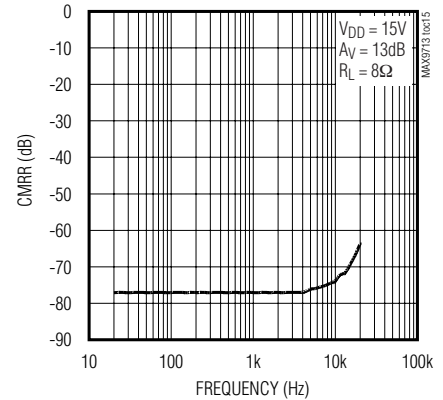

**POWER-SUPPLY REJECTION RATIO vs. FREQUENCY**

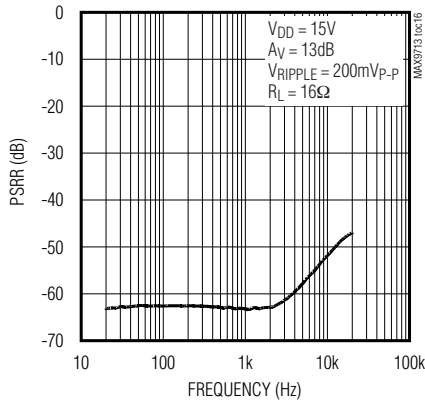

**CROSSTALK vs. FREQUENCY**

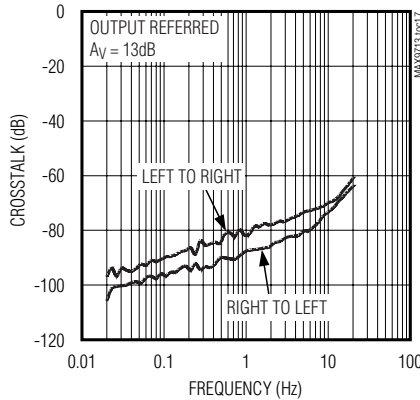

**OUTPUT FREQUENCY SPECTRUM**

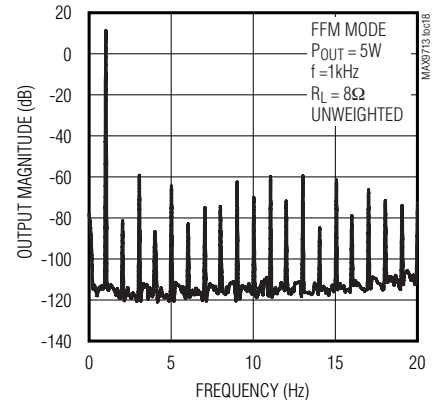

# 6W, Filterless, Spread-Spectrum Mono/Stereo Class D Amplifiers

## Typical Operating Characteristics (continued)

(136 $\mu$ H with 16 $\Omega$ , 68 $\mu$ H with 8 $\Omega$ , part in SSM mode, unless otherwise noted.)

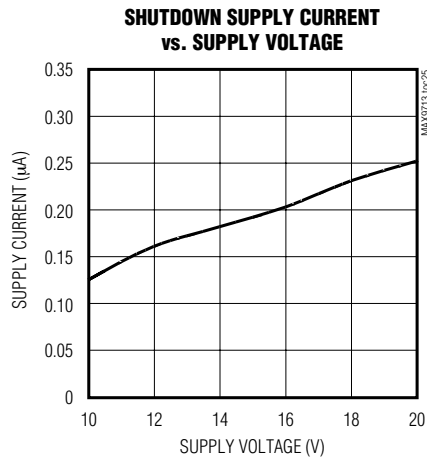
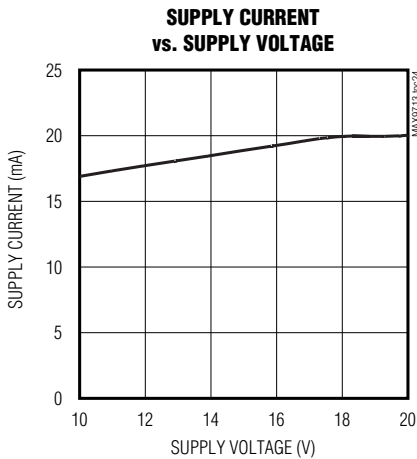
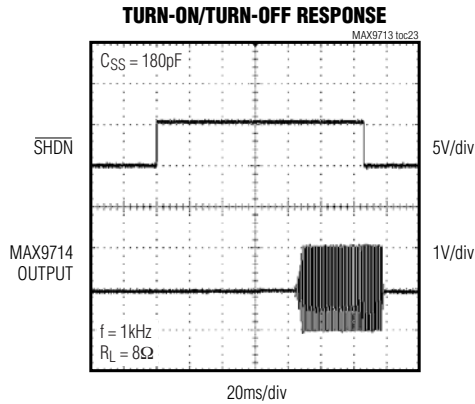
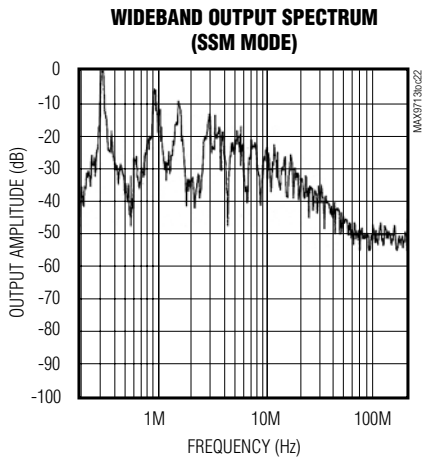
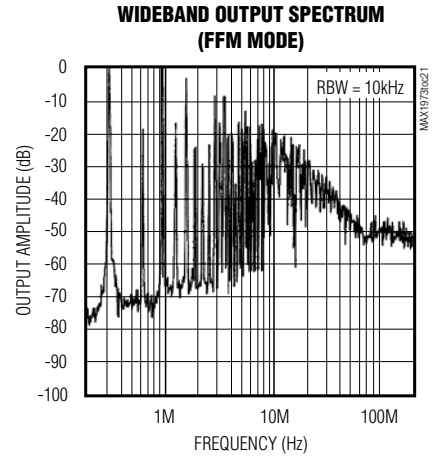
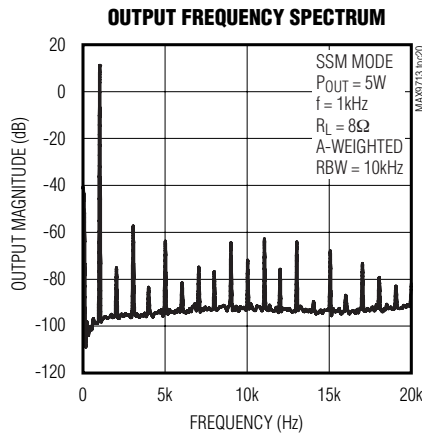
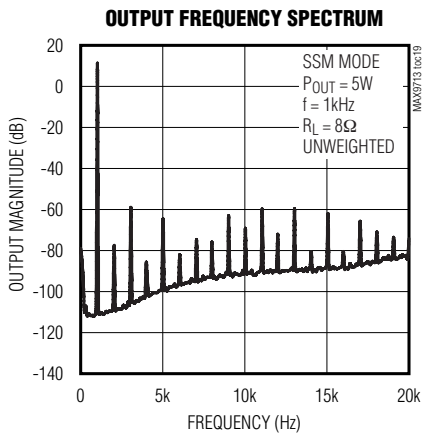

# 6W, Filterless, Spread-Spectrum Mono/Stereo Class D Amplifiers

## Pin Description

**MAX9713/MAX9714**

| PIN                       |              | NAME                     | FUNCTION   |
|---------------------------|--------------|--------------------------|--|
| MAX9713                   | MAX9714      |                          |  |
| 1, 2, 23, 24              | 1, 2, 23, 24 | PGND                     | Power Ground   |
| 3, 4, 21, 22              | 3, 4, 21, 22 | V <sub>DD</sub>          | Power-Supply Input   |
| 5                         | 5            | C1N                      | Charge-Pump Flying Capacitor Negative Terminal   |
| 6                         | 6            | C1P                      | Charge-Pump Flying Capacitor Positive Terminal   |
| 7                         | 7            | CHOLD                    | Charge-Pump Hold Capacitor. Connect a 1μF capacitor from CHOLD to V <sub>DD</sub> .  |
| 8, 17, 20, 25, 26, 31, 32 | 8            | N.C.                     | No Connection. Not internally connected.   |
| 9                         | 14           | REG                      | 6V Internal Regulator Output. Bypass with a 0.01μF capacitor to PGND.  |
| 10                        | 13           | AGND                     | Analog Ground  |
| 11                        | —            | IN-                      | Negative Input   |
| 12                        | —            | IN+                      | Positive Input   |
| 13                        | 12           | SS                       | Soft-Start. Connect a 0.47μF capacitor from SS to GND to enable soft-start feature.  |
| 14                        | 11           | $\overline{\text{SHDN}}$ | Active-Low Shutdown. Connect $\overline{\text{SHDN}}$ to GND to disable the device. Connect to V <sub>DD</sub> for normal operation. |
| 15                        | 17           | G1                       | Gain-Select Input 1  |
| 16                        | 18           | G2                       | Gain-Select Input 2  |
| 18                        | 19           | FS1                      | Frequency-Select Input 1   |
| 19                        | 20           | FS2                      | Frequency-Select Input 2   |
| 27, 28                    | —            | OUT-                     | Negative Audio Output  |
| 29, 30                    | —            | OUT+                     | Positive Audio Output  |
| —                         | 9            | INL-                     | Left-Channel Negative Input  |
| —                         | 10           | INL+                     | Left-Channel Positive Input  |
| —                         | 15           | INR-                     | Right-Channel Negative Input   |
| —                         | 16           | INR+                     | Right-Channel Positive Input   |
| —                         | 25, 26       | OUTR-                    | Right-Channel Negative Audio Output  |
| —                         | 27, 28       | OUTR+                    | Right-Channel Positive Audio Output  |
| —                         | 29, 30       | OUTL-                    | Left-Channel Negative Audio Output   |
| —                         | 31, 32       | OUTL+                    | Left-Channel Positive Audio Output   |
| —                         | —            | EP                       | Exposed Paddle. Connect to GND.  |

# 6W, Filterless, Spread-Spectrum Mono/Stereo Class D Amplifiers

## Detailed Description

The MAX9713/MAX9714 filterless, Class D audio power amplifiers feature several improvements to switch-mode amplifier technology. The MAX9713 is a mono amplifier, the MAX9714 is a stereo amplifier. These devices offer Class AB performance with Class D efficiency, while occupying minimal board space. A unique filterless modulation scheme and spread-spectrum switching mode create a compact, flexible, low-noise, efficient audio power amplifier. The differential input architecture reduces common-mode noise pickup, and can be used without input-coupling capacitors. The devices can also be configured as a single-ended input amplifier.

Comparators monitor the device inputs and compare the complementary input voltages to the triangle waveform. The comparators trip when the input magnitude of the triangle exceeds their corresponding input voltage.

## Operating Modes

### Fixed-Frequency Modulation (FFM) Mode

The MAX9713/MAX9714 feature three FFM modes with different switching frequencies (Table 1). In FFM mode, the frequency spectrum of the Class D output consists of the fundamental switching frequency and its associated harmonics (see the Wideband Output Spectrum (FFM Mode) graph in the *Typical Operating Characteristics*). The MAX9713/ MAX9714 allow the switching frequency to be changed by  $\pm 35\%$ , should the frequency of one or more of the harmonics fall in a sensitive band. This can be done at any time and not affect audio reproduction.

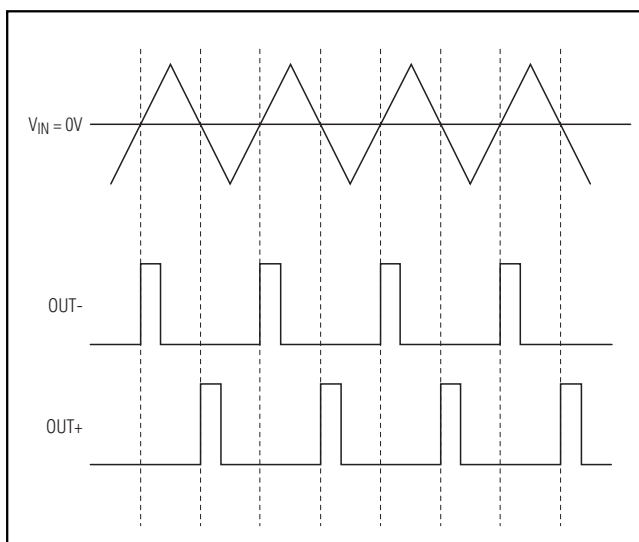

Figure 1. MAX9714 Outputs with No Input Signal Applied

Table 1. Operating Modes

| FS1 | FS2 | SWITCHING MODE (kHz) |
|-----|-----|----------------------|
| L   | L   | 335                  |
| L   | H   | 460                  |
| H   | L   | 236                  |
| H   | H   | 335 $\pm 7\%$        |

### Spread-Spectrum Modulation (SSM) Mode

The MAX9713/MAX9714 feature a unique spread-spectrum mode that flattens the wideband spectral components, improving EMI emissions that may be radiated by the speaker and cables. This mode is enabled by setting FS1 = FS2 = H. In SSM mode, the switching frequency varies randomly by  $\pm 1.7\%$  kHz around the center frequency (335 kHz). The modulation scheme remains the same, but the period of the triangle waveform changes from cycle to cycle. Instead of a large amount of spectral energy present at multiples of the switching frequency, the energy is now spread over a bandwidth that increases with frequency. Above a few megahertz, the wideband spectrum looks like white noise for EMI purposes (Figure 2).

## Efficiency

Efficiency of a Class D amplifier is attributed to the region of operation of the output stage transistors. In a Class D amplifier, the output transistors act as current-steering switches and consume negligible additional power. Any power loss associated with the Class D output stage is mostly due to the  $I^2R$  loss of the MOSFET on-resistance, and quiescent current overhead.

The theoretical best efficiency of a linear amplifier is 78%, however that efficiency is only exhibited at peak output powers. Under normal operating levels (typical music reproduction levels), efficiency falls below 30%, whereas the MAX9714 still exhibits  $>80\%$  efficiencies under the same conditions (Figure 3).

## Shutdown

The MAX9713/MAX9714 have a shutdown mode that reduces power consumption and extends battery life. Driving SHDN low places the device in low-power (0.2  $\mu$ A) shutdown mode. Connect SHDN to a logic high for normal operation.

## Click-and-Pop Suppression

The MAX9713/MAX9714 feature comprehensive click-and-pop suppression that eliminates audible transients on startup and shutdown. While in shutdown, the H-bridge is pulled to GND through 300 k $\Omega$ . During startup,



# 6W, Filterless, Spread-Spectrum Mono/Stereo Class D Amplifiers

MAX9713/MAX9714

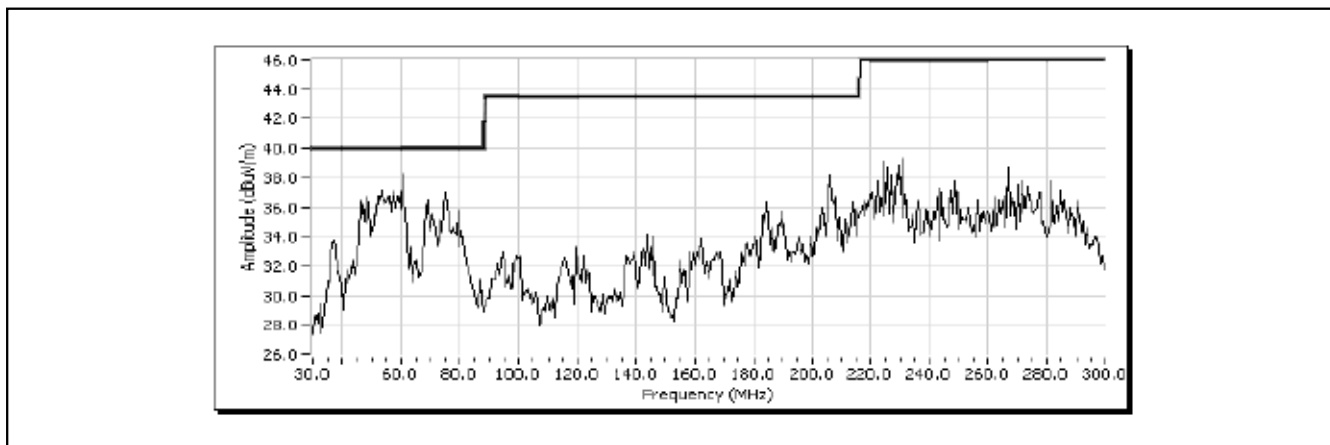

Figure 2. SSM Radiated Emissions

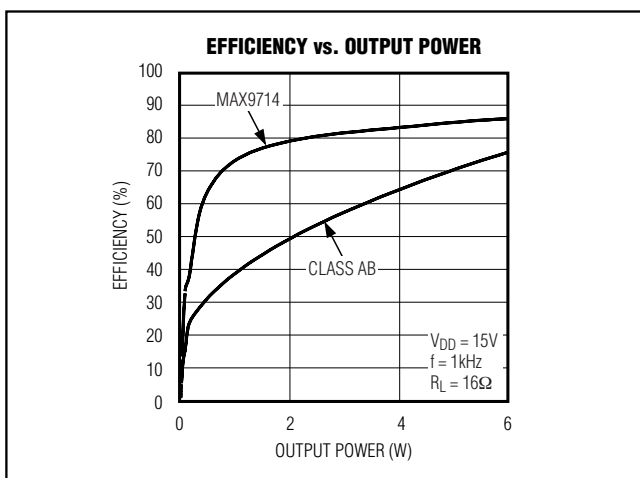

Figure 3. MAX9714 Efficiency vs. Class AB Efficiency

or power-up, the input amplifiers are muted and an internal loop sets the modulator bias voltages to the correct levels, preventing clicks and pops when the H-bridge is subsequently enabled. Following startup, a soft-start function gradually un-mutes the input amplifiers. The value of the soft-start capacitor has an impact on the click/pop levels. For optimum performance,  $C_{SS}$  should be at least  $0.18\mu\text{F}$ .

## Mute Function

The MAX9713/MAX9714 feature a clickless/popless mute mode. When the device is muted, the outputs stop switching, muting the speaker. Mute only affects the output state, and does not shut down the device. To mute the MAX9713/MAX9714, drive SS to GND by

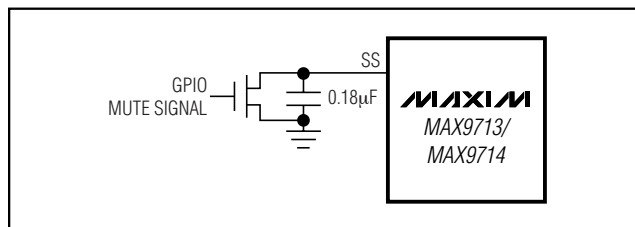

Figure 4. MAX9713/MAX9714 Mute Circuit

using a MOSFET pulldown (Figure 4). Driving SS to GND during the power-up/down or shutdown/turn-on cycle optimizes click-and-pop suppression.

## Applications Information

### Filterless Operation

Traditional Class D amplifiers require an output filter to recover the audio signal from the amplifier's PWM output. The filters add cost, increase the solution size of the amplifier, and can decrease efficiency. The traditional PWM scheme uses large differential output swings ( $2 \times V_{DD}$  peak-to-peak) and causes large ripple currents. Any parasitic resistance in the filter components results in a loss of power, lowering the efficiency.

The MAX9713/MAX9714 do not require an output filter. The devices rely on the inherent inductance of the speaker coil and the natural filtering of both the speaker and the human ear to recover the audio component of the square-wave output. Eliminating the output filter results in a smaller, less costly, more efficient solution.

Because the frequency of the MAX9713/MAX9714 output is well beyond the bandwidth of most speakers, voice coil movement due to the square-wave frequency

# 6W, Filterless, Spread-Spectrum Mono/Stereo Class D Amplifiers

Table 2. Gain Settings

| GAIN (dB) | DIFF INPUT (VRMS) | RL (Ω) | POUT at 10% THD+N (W) |
|-----------|-------------------|--------|-----------------------|
| 13.0      | 1.27              | 16     | 8                     |
| 16.1      | 0.89              | 16     | 8                     |
| 19.1      | 0.63              | 16     | 8                     |
| 22.1      | 0.45              | 16     | 8                     |
| 13.0      | 0.78              | 8      | 6                     |
| 16.1      | 0.54              | 8      | 6                     |
| 19.1      | 0.39              | 8      | 6                     |
| 22.1      | 0.27              | 8      | 6                     |

is very small. Although this movement is small, a speaker not designed to handle the additional power can be damaged. For optimum results, use a speaker with a series inductance > 30μH. Typical 8Ω speakers exhibit series inductances in the range of 30μH to 100μH. Optimum efficiency is achieved with speaker inductances > 60μH.

### Gain Selection

Table 2 shows the suggested gain settings to attain a maximum output power from a given peak input voltage and given load.

### Internal Regulator Output (VREG)

The MAX9713/MAX9714 feature an internal, 6V regulator output (VREG). The MAX9713/MAX9714 REG output pin simplifies system design and reduces system cost by providing a logic voltage high for the MAX9713/MAX9714 logic pins (G\_, FS\_). VREG is not available as a logic voltage high in shutdown mode. Do not apply VREG as an input voltage high to the MAX9713/MAX9714 SHDN pin. Do not apply VREG as a 6V potential to surrounding system components. Bypass REG with a 6.3V, 0.01μF capacitor to GND.

### Output Offset

Unlike a Class AB amplifier, the output offset voltage of Class D amplifiers does not noticeably increase quiescent current draw when a load is applied. This is due to the power conversion of the Class D amplifier. For example, an 8mV DC offset across an 8Ω load results in 1mA extra current consumption in a Class AB device. In the Class D case, an 8mV offset into 8Ω equates to an additional power drain of 8μW. Due to the high efficiency of the Class D amplifier, this represents an additional quiescent current draw of:  $8\mu\text{W}/(V_{\text{DD}}/100 \times \eta)$ , which is on the order of a few microamps.

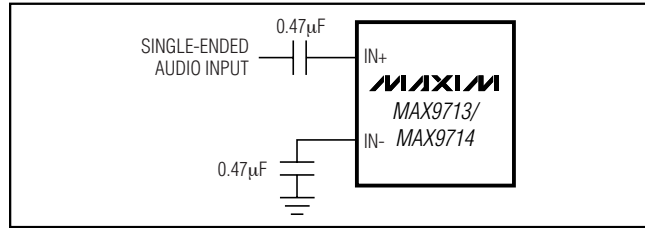

Figure 5. Single-Ended Input

### Input Amplifier

#### Differential Input

The MAX9713/MAX9714 feature a differential input structure, making them compatible with many CODECs, and offering improved noise immunity over a single-ended input amplifier. In devices such as PCs, noisy digital signals can be picked up by the amplifier's input traces. The signals appear at the amplifiers' inputs as common-mode noise. A differential input amplifier amplifies the difference of the two inputs, any signal common to both inputs is canceled.

#### Single-Ended Input

The MAX9713/MAX9714 can be configured as single-ended input amplifiers by capacitively coupling either input to GND and driving the other input (Figure 5).

### Component Selection

#### Input Filter

An input capacitor,  $C_{\text{IN}}$ , in conjunction with the input impedance of the MAX9713/MAX9714, forms a high-pass filter that removes the DC bias from an incoming signal. The AC-coupling capacitor allows the amplifier to bias the signal to an optimum DC level. Assuming zero-source impedance, the -3dB point of the highpass filter is given by:

$$f_{-3\text{dB}} = \frac{1}{2\pi R_{\text{IN}} C_{\text{IN}}}$$

Choose  $C_{\text{IN}}$  so  $f_{-3\text{dB}}$  is well below the lowest frequency of interest. Setting  $f_{-3\text{dB}}$  too high affects the low-frequency response of the amplifier. Use capacitors whose dielectrics have low-voltage coefficients, such as tantalum or aluminum electrolytic. Capacitors with high-voltage coefficients, such as ceramics, may result in increased distortion at low frequencies.

#### Charge-Pump Capacitor Selection

Use capacitors with an ESR less than 100mΩ for optimum performance. Low-ESR ceramic capacitors minimize the output resistance of the charge pump. For best performance over the extended temperature range, select capacitors with an X7R dielectric.

# 6W, Filterless, Spread-Spectrum Mono/Stereo Class D Amplifiers

## Flying Capacitor (C1)

The value of the flying capacitor (C1) affects the load regulation and output resistance of the charge pump. A C1 value that is too small degrades the device's ability to provide sufficient current drive. Increasing the value of C1 improves load regulation and reduces the charge-pump output resistance to an extent. Above 1 $\mu$ F, the on-resistance of the switches and the ESR of C1 and C2 dominate.

## Output Capacitor (C2)

The output capacitor value and ESR directly affect the ripple at CHOLD. Increasing C2 reduces output ripple. Likewise, decreasing the ESR of C2 reduces both ripple and output resistance. Lower capacitance values can be used in systems with low maximum output power levels.

## Output Filter

The MAX9713/MAX9714 do not require an output filter. The device passes FCC emissions standards with 36cm of unshielded speaker cables. However, output filtering can be used if a design is failing radiated emissions due to board layout or cable length, or the circuit is near EMI-sensitive devices. Use a ferrite bead filter when radiated frequencies above 10MHz are of concern. Use an LC filter when radiated frequencies below 10MHz are of concern, or when long leads connect the

amplifier to the speaker. Refer to the MAX9714 Evaluation Kit schematic for details of this filter.

## Sharing Input Sources

In certain systems, a single audio source can be shared by multiple devices (speaker and headphone amplifiers). When sharing inputs, it is common to mute the unused device, rather than completely shutting it down, preventing the unused device inputs from distorting the input signal. Mute the MAX9713/MAX9714 by driving SS low through an open-drain output or MOSFET (see the *System Diagram*). Driving SS low turns off the Class D output stage, but does not affect the input bias levels of the MAX9713/MAX9714. Be aware that during normal operation, the voltage at SS can be up to 7V, depending on the MAX9713/MAX9714 supply.

## Supply Bypassing/Layout

Proper power-supply bypassing ensures low distortion operation. For optimum performance, bypass V<sub>DD</sub> to PGND with a 0.1 $\mu$ F capacitor as close to each V<sub>DD</sub> pin as possible. A low-impedance, high-current power-supply connection to V<sub>DD</sub> is assumed. Additional bulk capacitance should be added as required depending on the application and power-supply characteristics. AGND and PGND should be star connected to system ground. Refer to the MAX9714 Evaluation Kit for layout guidance.

## Pin Configurations

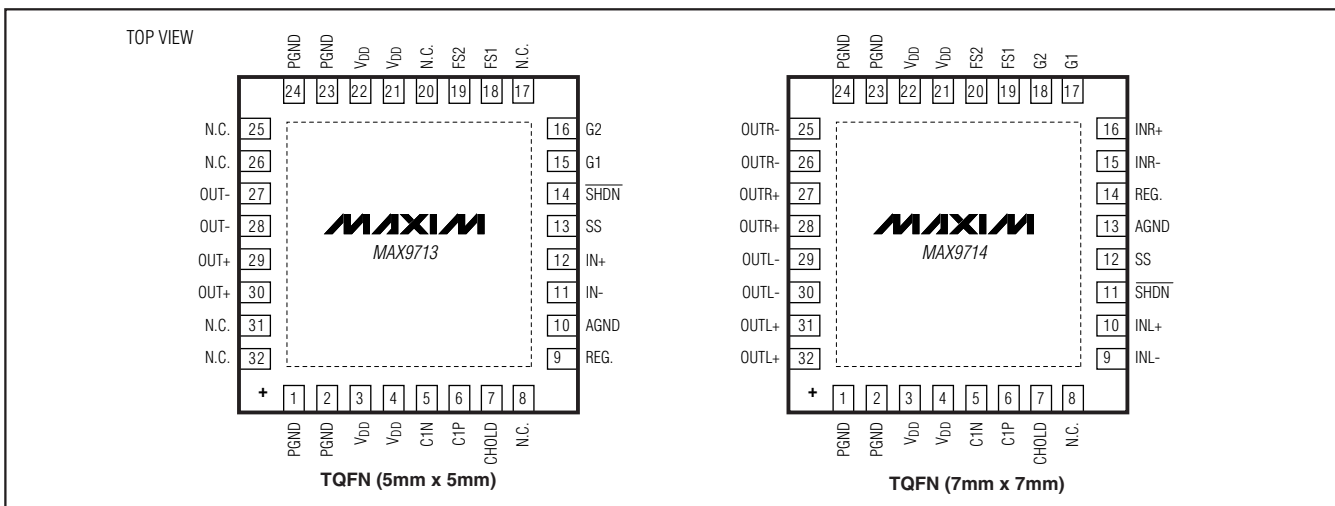

## Chip Information

MAX9713 TRANSISTOR COUNT: 3093

MAX9714 TRANSISTOR COUNT: 4630

PROCESS: BICMOS

# 6W, Filterless, Spread-Spectrum Mono/Stereo Class D Amplifiers

## Functional Diagrams

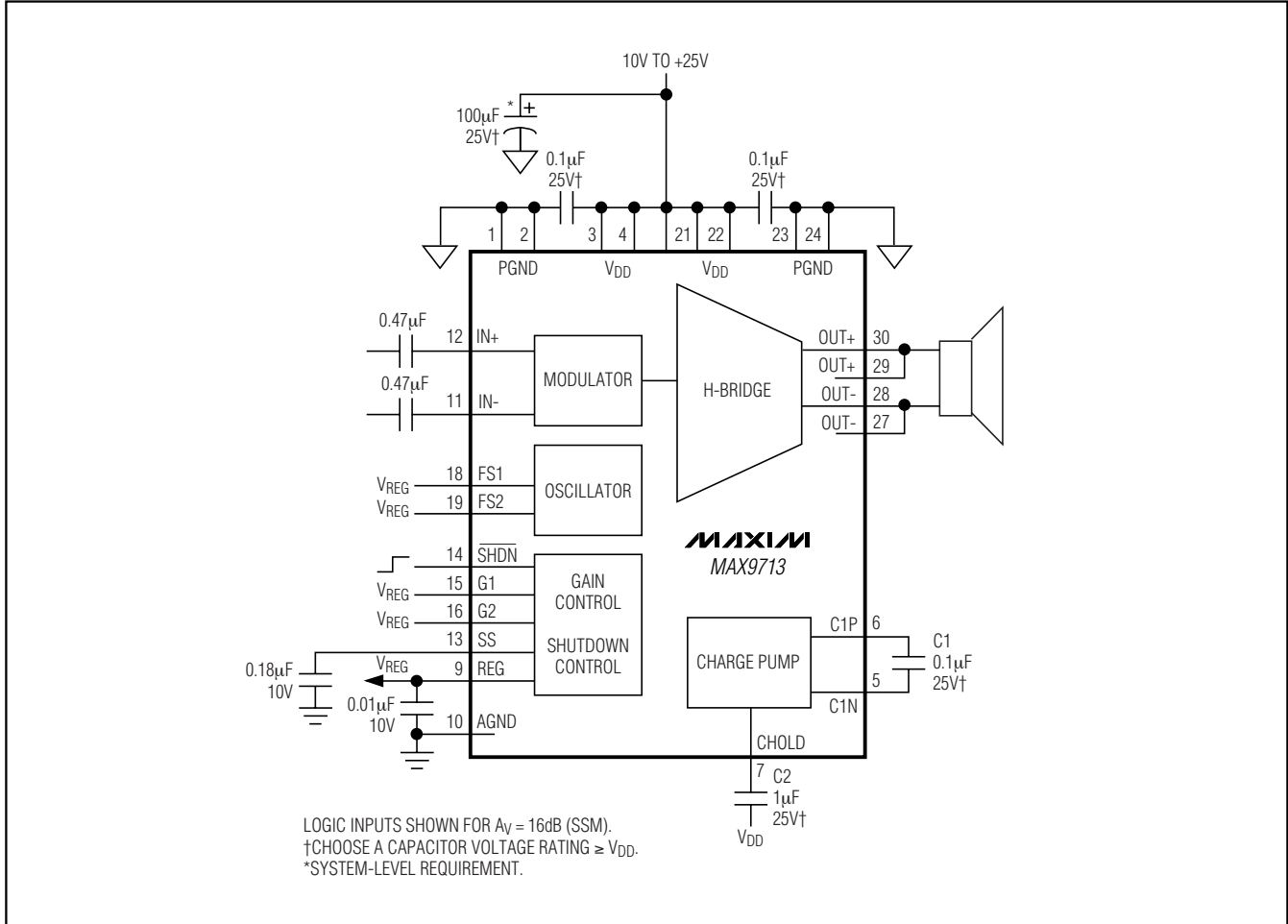

# 6W, Filterless, Spread-Spectrum Mono/Stereo Class D Amplifiers

## Functional Diagrams (continued)

MAX9713/MAX9714

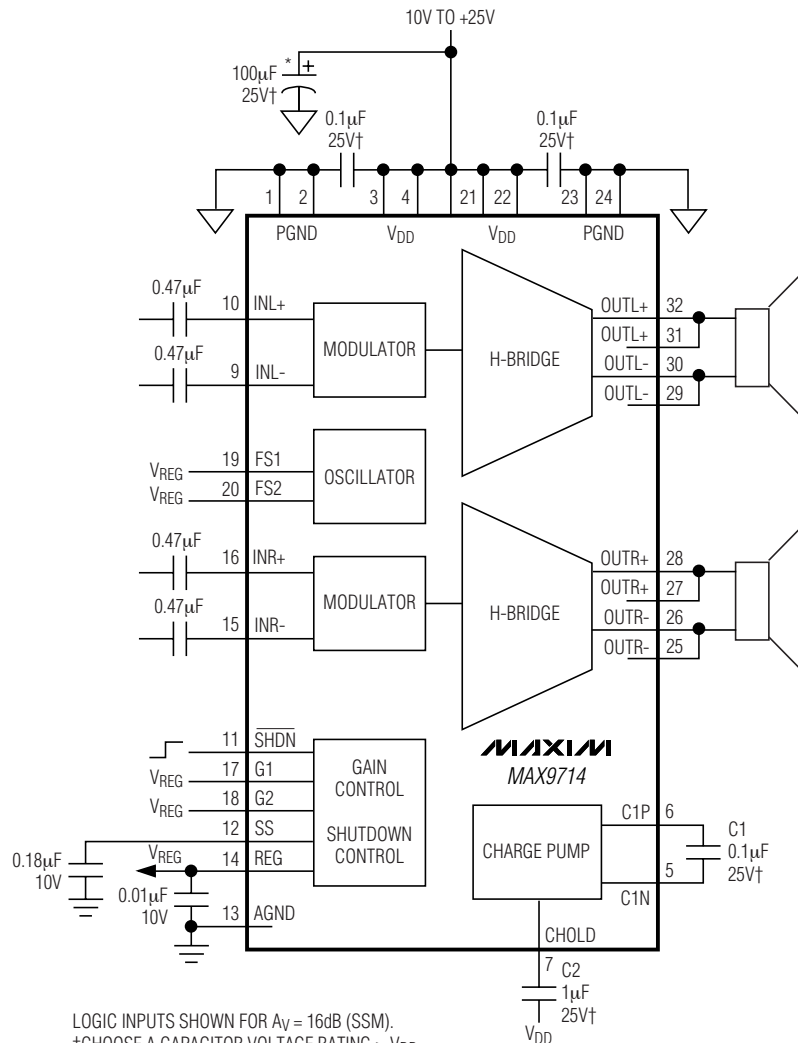

LOGIC INPUTS SHOWN FOR  $A_V = 16\text{dB}$  (SSM).  
 †CHOOSE A CAPACITOR VOLTAGE RATING  $\geq V_{DD}$ .  
 \*SYSTEM-LEVEL REQUIREMENT.

# 6W, Filterless, Spread-Spectrum Mono/Stereo Class D Amplifiers

## System Diagram

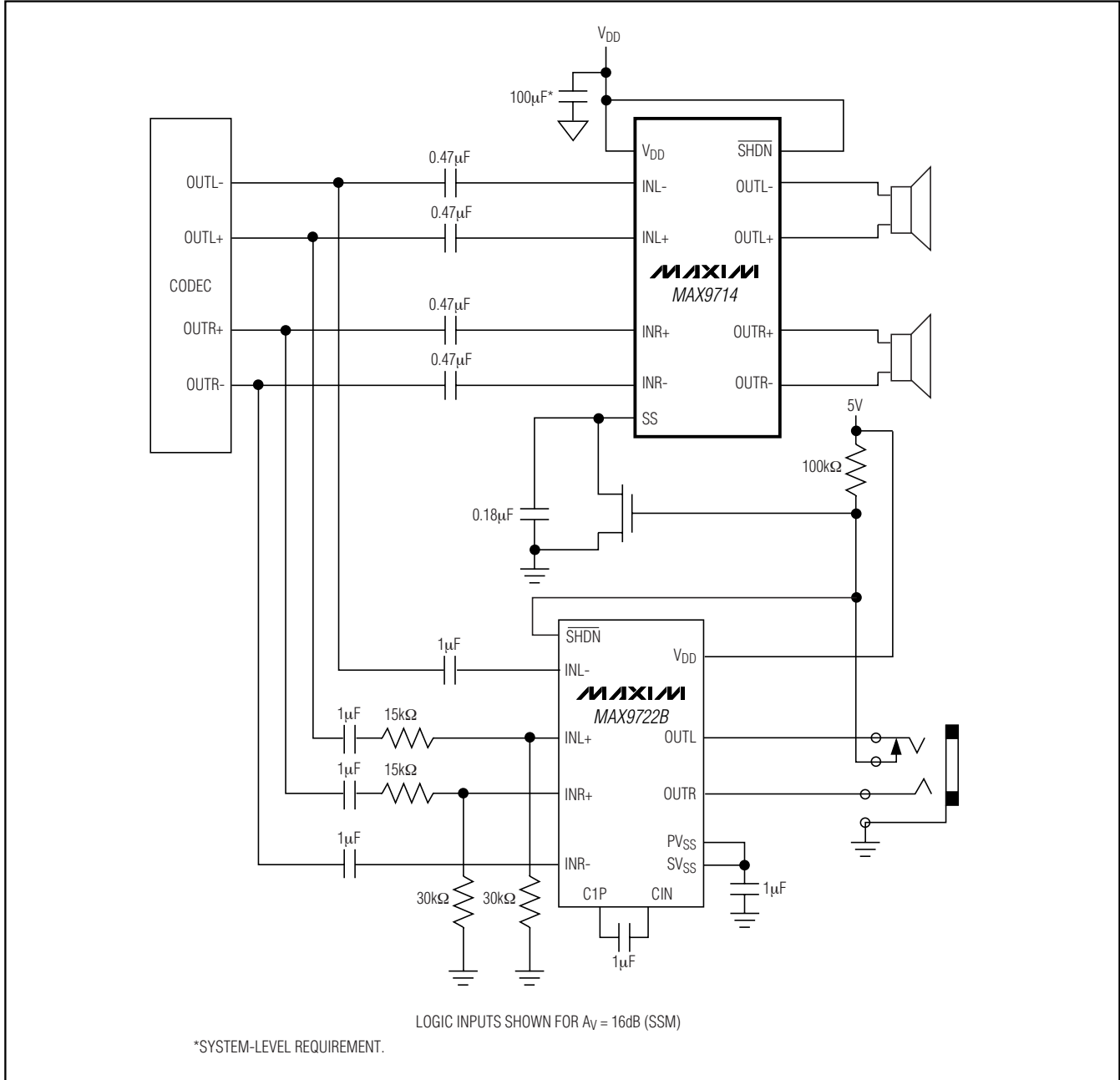

# 6W, Filterless, Spread-Spectrum Mono/Stereo Class D Amplifiers

## Package Information

(The package drawing(s) in this data sheet may not reflect the most current specifications. For the latest package outline information, go to [www.maxim-ic.com/packages](http://www.maxim-ic.com/packages).)

MAX9713/MAX9714

32, 44, 48L QFN.EPS

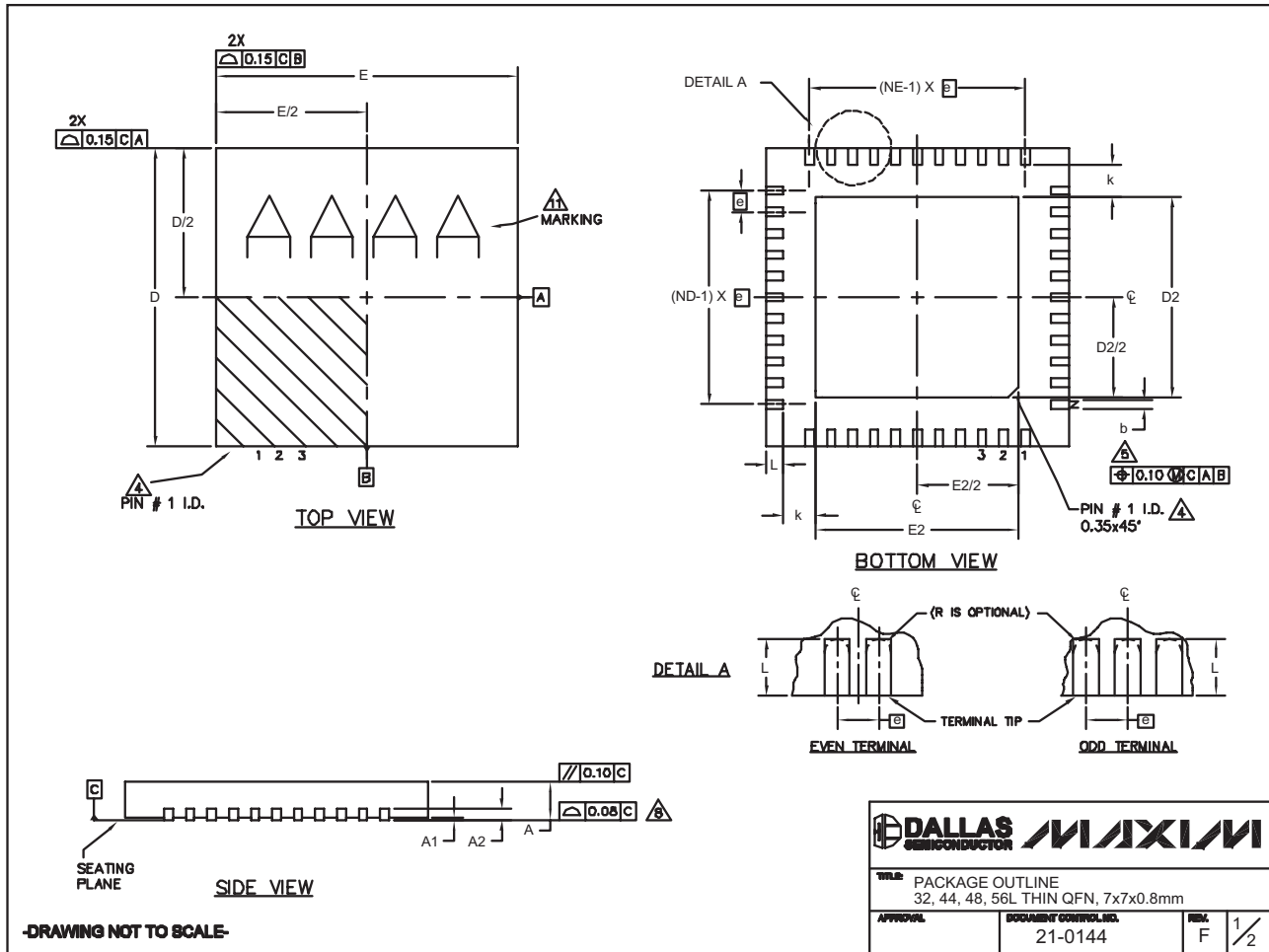

# 6W, Filterless, Spread-Spectrum Mono/Stereo Class D Amplifiers

## Package Information (continued)

(The package drawing(s) in this data sheet may not reflect the most current specifications. For the latest package outline information, go to [www.maxim-ic.com/packages](http://www.maxim-ic.com/packages).)

| COMMON DIMENSIONS |           |      |      |           |      |      |           |      |      |                          |      |      |           |      |      |
|-------------------|-----------|------|------|-----------|------|------|-----------|------|------|--------------------------|------|------|-----------|------|------|
| PKG               | 32L 7x7   |      |      | 44L 7x7   |      |      | 48L 7x7   |      |      | CUSTOM PKG.<br>(T4877-1) |      |      | 56L 7x7   |      |      |
|                   | MIN.      | NOM. | MAX. | MIN.      | NOM. | MAX. | MIN.      | NOM. | MAX. | MIN.                     | NOM. | MAX. | MIN.      | NOM. | MAX. |
| SYMBOL            |           |      |      |           |      |      |           |      |      |                          |      |      |           |      |      |
| A                 | 0.70      | 0.75 | 0.80 | 0.70      | 0.75 | 0.80 | 0.70      | 0.75 | 0.80 | 0.70                     | 0.75 | 0.80 | 0.70      | 0.75 | 0.80 |
| A1                | 0         | 0.02 | 0.05 | 0         | 0.02 | 0.05 | 0         | 0.02 | 0.05 | 0                        | 0.02 | 0.05 | 0         | -    | 0.05 |
| A2                | 0.20 REF. |      |      | 0.20 REF. |      |      | 0.20 REF. |      |      | 0.20 REF.                |      |      | 0.20 REF. |      |      |
| b                 | 0.25      | 0.30 | 0.35 | 0.20      | 0.25 | 0.30 | 0.20      | 0.25 | 0.30 | 0.20                     | 0.25 | 0.30 | 0.15      | 0.20 | 0.25 |
| D                 | 6.90      | 7.00 | 7.10 | 6.90      | 7.00 | 7.10 | 6.90      | 7.00 | 7.10 | 6.90                     | 7.00 | 7.10 | 6.90      | 7.00 | 7.10 |
| E                 | 6.90      | 7.00 | 7.10 | 6.90      | 7.00 | 7.10 | 6.90      | 7.00 | 7.10 | 6.90                     | 7.00 | 7.10 | 6.90      | 7.00 | 7.10 |
| e                 | 0.85 BSC. |      |      | 0.50 BSC. |      |      | 0.50 BSC. |      |      | 0.50 BSC.                |      |      | 0.40 BSC. |      |      |
| k                 | 0.25      | -    | -    | 0.25      | -    | -    | 0.25      | -    | -    | 0.25                     | -    | -    | 0.25      | -    | -    |
| L                 | 0.45      | 0.55 | 0.65 | 0.45      | 0.55 | 0.65 | 0.30      | 0.40 | 0.50 | 0.45                     | 0.55 | 0.65 | 0.30      | 0.40 | 0.50 |
| N                 | 32        |      |      | 44        |      |      | 48        |      |      | 44                       |      |      | 56        |      |      |
| ND                | 8         |      |      | 11        |      |      | 12        |      |      | 10                       |      |      | 14        |      |      |
| NE                | 8         |      |      | 11        |      |      | 12        |      |      | 12                       |      |      | 14        |      |      |

| EXPOSED PAD VARIATIONS |                   |      |      |      |      |      |      |                    |  |
|------------------------|-------------------|------|------|------|------|------|------|--------------------|--|
| PKG. CODES             | DEPOPULATED LEADS | D2   |      |      | E2   |      |      | JEDEC MO220 REV. C |  |
|                        |                   | MIN. | NOM. | MAX. | MIN. | NOM. | MAX. |                    |  |
| T3277-2                | -                 | 4.55 | 4.70 | 4.85 | 4.55 | 4.70 | 4.85 | -                  |  |
| T3277-3                | -                 | 4.55 | 4.70 | 4.85 | 4.55 | 4.70 | 4.85 | -                  |  |
| T4477-2                | -                 | 4.55 | 4.70 | 4.85 | 4.55 | 4.70 | 4.85 | WKGD-1             |  |
| T4477-3                | -                 | 4.55 | 4.70 | 4.85 | 4.55 | 4.70 | 4.85 | WKGD-1             |  |
| T4877-1**              | 13,24,37,48       | 4.20 | 4.30 | 4.40 | 4.20 | 4.30 | 4.40 | -                  |  |
| T4877-3                | -                 | 4.95 | 5.10 | 5.25 | 4.95 | 5.10 | 5.25 | -                  |  |
| T4877-4                | -                 | 5.40 | 5.50 | 5.60 | 5.40 | 5.50 | 5.60 | -                  |  |
| T4877-5                | -                 | 2.40 | 2.50 | 2.60 | 2.40 | 2.50 | 2.60 | -                  |  |
| T4877-6                | -                 | 5.40 | 5.50 | 5.60 | 5.40 | 5.50 | 5.60 | -                  |  |
| T4877-7                | -                 | 4.95 | 5.10 | 5.25 | 4.95 | 5.10 | 5.25 | -                  |  |
| T4877M-1               | -                 | 5.40 | 5.50 | 5.60 | 5.40 | 5.50 | 5.60 | -                  |  |
| T4877M-6               | -                 | 5.40 | 5.50 | 5.60 | 5.40 | 5.50 | 5.60 | -                  |  |
| T4877MN-8              | -                 | 5.40 | 5.50 | 5.60 | 5.40 | 5.50 | 5.60 | -                  |  |
| T5677-1                | -                 | 5.40 | 5.50 | 5.60 | 5.40 | 5.50 | 5.60 | -                  |  |
| T5677-2                | -                 | 5.40 | 5.50 | 5.60 | 5.40 | 5.50 | 5.60 | -                  |  |

\*\* NOTE: T4877-1 IS A CUSTOM 48L PKG. WITH 4 LEADS DEPOPULATED. TOTAL NUMBER OF LEADS ARE 44.

**NOTES:**

- DIMENSIONING & TOLERANCING CONFORM TO ASME Y14.5M-1994.
- ALL DIMENSIONS ARE IN MILLIMETERS. ANGLES ARE IN DEGREES.
- N IS THE TOTAL NUMBER OF TERMINALS.
- THE TERMINAL #1 IDENTIFIER AND TERMINAL NUMBERING CONVENTION SHALL CONFORM TO JESD 95-1 SPP-012. DETAILS OF TERMINAL #1 IDENTIFIER ARE OPTIONAL, BUT MUST BE LOCATED WITHIN THE ZONE INDICATED. THE TERMINAL #1 IDENTIFIER MAY BE EITHER A MOLD OR MARKED FEATURE.
- DIMENSION b APPLIES TO METALLIZED TERMINAL AND IS MEASURED BETWEEN 0.25 mm AND 0.30 mm FROM TERMINAL TIP.
- ND AND NE REFER TO THE NUMBER OF TERMINALS ON EACH D AND E SIDE RESPECTIVELY.
- DEPOPULATION IS POSSIBLE IN A SYMMETRICAL FASHION.
- COPLANARITY APPLIES TO THE EXPOSED HEAT SINK SLUG AS WELL AS THE TERMINALS.
- DRAWING CONFORMS TO JEDEC MO220 EXCEPT THE EXPOSED PAD DIMENSIONS OF T4877-1/-3/-4/-5/-6 & T5677-1.
- WARPAGE SHALL NOT EXCEED 0.10 mm.
- MARKING IS FOR PACKAGE ORIENTATION REFERENCE ONLY
- NUMBER OF LEADS SHOWN ARE FOR REFERENCE ONLY

**-DRAWING NOT TO SCALE-**

|   |                                  |
|---|----------------------------------|
|   |                                  |
| TITLE: PACKAGE OUTLINE<br>32, 44, 48, 56L THIN QFN, 7x7x0.8mm |                                  |
| APPROVAL:   | DOCUMENT CONTROL NO.:<br>21-0144 |
| REL: F  | 2/2                              |



# 6W, Filterless, Spread-Spectrum Mono/Stereo Class D Amplifiers

## Package Information (continued)

(The package drawing(s) in this data sheet may not reflect the most current specifications. For the latest package outline information, go to [www.maxim-ic.com/packages](http://www.maxim-ic.com/packages).)

MAX9713/MAX9714

QFN THIN.EPS

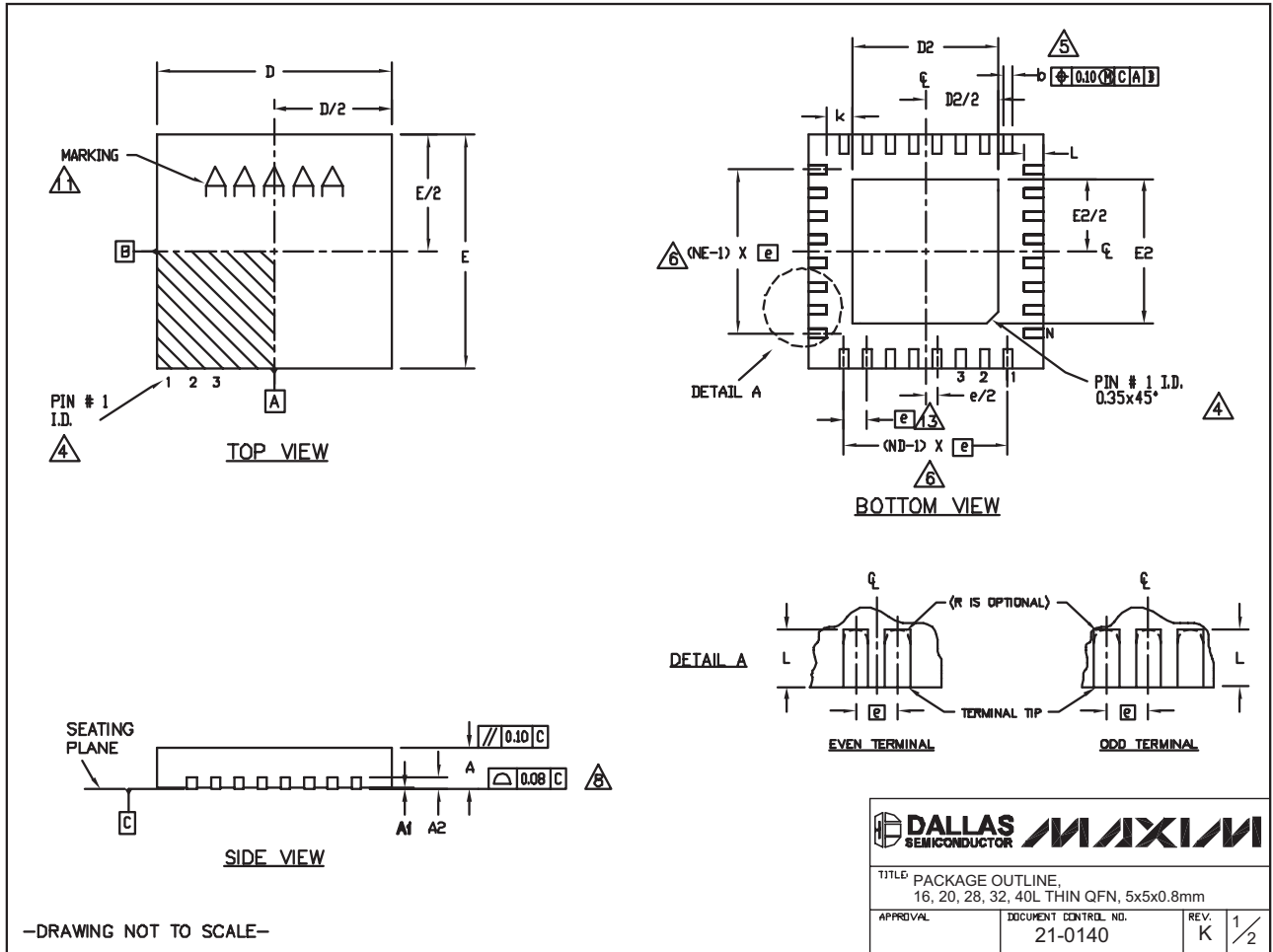

# 6W, Filterless, Spread-Spectrum Mono/Stereo Class D Amplifiers

## Package Information (continued)

(The package drawing(s) in this data sheet may not reflect the most current specifications. For the latest package outline information, go to [www.maxim-ic.com/packages](http://www.maxim-ic.com/packages).)

| COMMON DIMENSIONS |           |      |      |           |      |      |           |      |      |           |      |      |           |      |      |
|-------------------|-----------|------|------|-----------|------|------|-----------|------|------|-----------|------|------|-----------|------|------|
| PKG.              | 16L 5x5   |      |      | 20L 5x5   |      |      | 28L 5x5   |      |      | 32L 5x5   |      |      | 40L 5x5   |      |      |
| SYMBOL            | MIN.      | NOM. | MAX. | MIN.      | NOM. | MAX. | MIN.      | NOM. | MAX. | MIN.      | NOM. | MAX. | MIN.      | NOM. | MAX. |
| A                 | 0.70      | 0.75 | 0.80 | 0.70      | 0.75 | 0.80 | 0.70      | 0.75 | 0.80 | 0.70      | 0.75 | 0.80 | 0.70      | 0.75 | 0.80 |
| A1                | 0         | 0.02 | 0.05 | 0         | 0.02 | 0.05 | 0         | 0.02 | 0.05 | 0         | 0.02 | 0.05 | 0         | 0.02 | 0.05 |
| A2                | 0.20 REF. |      |      | 0.20 REF. |      |      | 0.20 REF. |      |      | 0.20 REF. |      |      | 0.20 REF. |      |      |
| b                 | 0.25      | 0.30 | 0.35 | 0.25      | 0.30 | 0.35 | 0.20      | 0.25 | 0.30 | 0.20      | 0.25 | 0.30 | 0.15      | 0.20 | 0.25 |
| D                 | 4.90      | 5.00 | 5.10 | 4.90      | 5.00 | 5.10 | 4.90      | 5.00 | 5.10 | 4.90      | 5.00 | 5.10 | 4.90      | 5.00 | 5.10 |
| E                 | 4.90      | 5.00 | 5.10 | 4.90      | 5.00 | 5.10 | 4.90      | 5.00 | 5.10 | 4.90      | 5.00 | 5.10 | 4.90      | 5.00 | 5.10 |
| e                 | 0.80 BSC. |      |      | 0.65 BSC. |      |      | 0.50 BSC. |      |      | 0.50 BSC. |      |      | 0.40 BSC. |      |      |
| k                 | 0.25      | -    | -    | 0.25      | -    | -    | 0.25      | -    | -    | 0.25      | -    | -    | 0.25      | -    | -    |
| L                 | 0.30      | 0.40 | 0.50 | 0.45      | 0.55 | 0.65 | 0.45      | 0.55 | 0.65 | 0.30      | 0.40 | 0.50 | 0.30      | 0.40 | 0.50 |
| N                 | 16        |      |      | 20        |      |      | 28        |      |      | 32        |      |      | 40        |      |      |
| ND                | 4         |      |      | 5         |      |      | 7         |      |      | 8         |      |      | 10        |      |      |
| NE                | 4         |      |      | 5         |      |      | 7         |      |      | 8         |      |      | 10        |      |      |
| JEDEC             | VHHB      |      |      | WHHC      |      |      | WHHD-1    |      |      | WHHD-2    |      |      | -----     |      |      |

| EXPOSED PAD VARIATIONS |      |      |      |      |      |      |
|------------------------|------|------|------|------|------|------|
| PKG. CODES             | D2   |      |      | E2   |      |      |
|                        | MIN. | NOM. | MAX. | MIN. | NOM. | MAX. |
| T1655-2                | 3.00 | 3.10 | 3.20 | 3.00 | 3.10 | 3.20 |
| T1655-3                | 3.00 | 3.10 | 3.20 | 3.00 | 3.10 | 3.20 |
| T1655N-1               | 3.00 | 3.10 | 3.20 | 3.00 | 3.10 | 3.20 |
| T2055-3                | 3.00 | 3.10 | 3.20 | 3.00 | 3.10 | 3.20 |
| T2055-4                | 3.00 | 3.10 | 3.20 | 3.00 | 3.10 | 3.20 |
| T2055-5                | 3.15 | 3.25 | 3.35 | 3.15 | 3.25 | 3.35 |
| T2055M-5               | 3.15 | 3.25 | 3.35 | 3.15 | 3.25 | 3.35 |
| T2855-3                | 3.15 | 3.25 | 3.35 | 3.15 | 3.25 | 3.35 |
| T2855-4                | 2.60 | 2.70 | 2.80 | 2.60 | 2.70 | 2.80 |
| T2855-5                | 2.60 | 2.70 | 2.80 | 2.60 | 2.70 | 2.80 |
| T2855-6                | 3.15 | 3.25 | 3.35 | 3.15 | 3.25 | 3.35 |
| T2855-7                | 2.60 | 2.70 | 2.80 | 2.60 | 2.70 | 2.80 |
| T2855-8                | 3.15 | 3.25 | 3.35 | 3.15 | 3.25 | 3.35 |
| T2855N-1               | 3.15 | 3.25 | 3.35 | 3.15 | 3.25 | 3.35 |
| T3255-3                | 3.00 | 3.10 | 3.20 | 3.00 | 3.10 | 3.20 |
| T3255-4                | 3.00 | 3.10 | 3.20 | 3.00 | 3.10 | 3.20 |
| T3255M-4               | 3.00 | 3.10 | 3.20 | 3.00 | 3.10 | 3.20 |
| T3255-5                | 3.00 | 3.10 | 3.20 | 3.00 | 3.10 | 3.20 |
| T3255N-1               | 3.00 | 3.10 | 3.20 | 3.00 | 3.10 | 3.20 |
| T4055-1                | 3.40 | 3.50 | 3.60 | 3.40 | 3.50 | 3.60 |
| T4055-2                | 3.40 | 3.50 | 3.60 | 3.40 | 3.50 | 3.60 |

**NOTES:**

- DIMENSIONING & TOLERANCING CONFORM TO ASME Y14.5M-1994.
- ALL DIMENSIONS ARE IN MILLIMETERS. ANGLES ARE IN DEGREES.
- N IS THE TOTAL NUMBER OF TERMINALS.
- THE TERMINAL #1 IDENTIFIER AND TERMINAL NUMBERING CONVENTION SHALL CONFORM TO JEDEC 95-1 SPP-012. DETAILS OF TERMINAL #1 IDENTIFIER ARE OPTIONAL, BUT MUST BE LOCATED WITHIN THE ZONE INDICATED. THE TERMINAL #1 IDENTIFIER MAY BE EITHER A MOLD OR MARKED FEATURE.
- DIMENSION b APPLIES TO METALLIZED TERMINAL AND IS MEASURED BETWEEN 0.25 mm AND 0.30 mm FROM TERMINAL TIP.
- ND AND NE REFER TO THE NUMBER OF TERMINALS ON EACH D AND E SIDE RESPECTIVELY.
- DEPOPULATION IS POSSIBLE IN A SYMMETRICAL FASHION.
- COPLANARITY APPLIES TO THE EXPOSED HEAT SINK SLUG AS WELL AS THE TERMINALS.
- DRAWING CONFORMS TO JEDEC MO220, EXCEPT EXPOSED PAD DIMENSION FOR T2855-3, T2855-6, T4055-1 AND T4055-2.
- WARPAGE SHALL NOT EXCEED 0.10 mm.
- MARKING IS FOR PACKAGE ORIENTATION REFERENCE ONLY.
- NUMBER OF LEADS SHOWN ARE FOR REFERENCE ONLY.
- LEAD CENTERLINES TO BE AT TRUE POSITION AS DEFINED BY BASIC DIMENSION 'e', ±0.05.

-DRAWING NOT TO SCALE-

|  |                                 |               |
|--|---------------------------------|---------------|
|  |                                 |               |
| TITLE: PACKAGE OUTLINE,<br>16, 20, 28, 32, 40L THIN QFN, 5x5x0.8mm |                                 |               |
| APPROVAL   | DOCUMENT CONTROL NO.<br>21-0140 | REV.<br>K 2/2 |

## Revision History

Pages changed at Rev 6: 1, 3, 18

Maxim cannot assume responsibility for use of any circuitry other than circuitry entirely embodied in a Maxim product. No circuit patent licenses are implied. Maxim reserves the right to change the circuitry and specifications without notice at any time.

18 **Maxim Integrated Products, 120 San Gabriel Drive, Sunnyvale, CA 94086 408-737-7600**

# Mouser Electronics

Authorized Distributor

Click to View Pricing, Inventory, Delivery & Lifecycle Information:

[Maxim Integrated:](#)

[MAX9713ETJ+](#) [MAX9714ETJ+](#) [MAX9713ETJ+T](#) [MAX9714ETJ+T](#)