

## Specification for Speaker

Model No.	VS87x87R4F300P5	Drawing No.	VS201911280912
Customer	Quartz1		

### SPEC

NO.	Items	Specification	Test Condition
1	Impedance	4Ω ±15%	at 1Vrms,0.7kHz
2	Resonant Fr. (fo)	300Hz±20%	
3	Frequency Range	F0-20KHz	
4	Rated Power	5W	
5	Max Power	7W	
6	S.P.L.	95dB±3dB	(0.1W/0.1M at0.8,1.0,1.2,1.5kHz Ave)
7	Distortion	<10% Max.	at 2kHz/2Vrms
8	Sweep Test	must be normal	at sine wave 4.5V
9	Load Test	after test meet item 8	rated white noise power, 96 Hrs.
10	Heat Test	after test meet item 8	+60±2℃ 20~50% 96Hrs.
11	Cold Test	after test meet item 8	-20±3℃ 96Hrs.
12	Humidity Test	after test meet item 8	+40±2℃,90~95% 96Hrs.
13	Weight	250g	
14	Polarity Test	with positive D.C. voltage to (+) terminal, the cone shall move forward.	
15	Waterproof	IP64	

### Frequency Response Curve

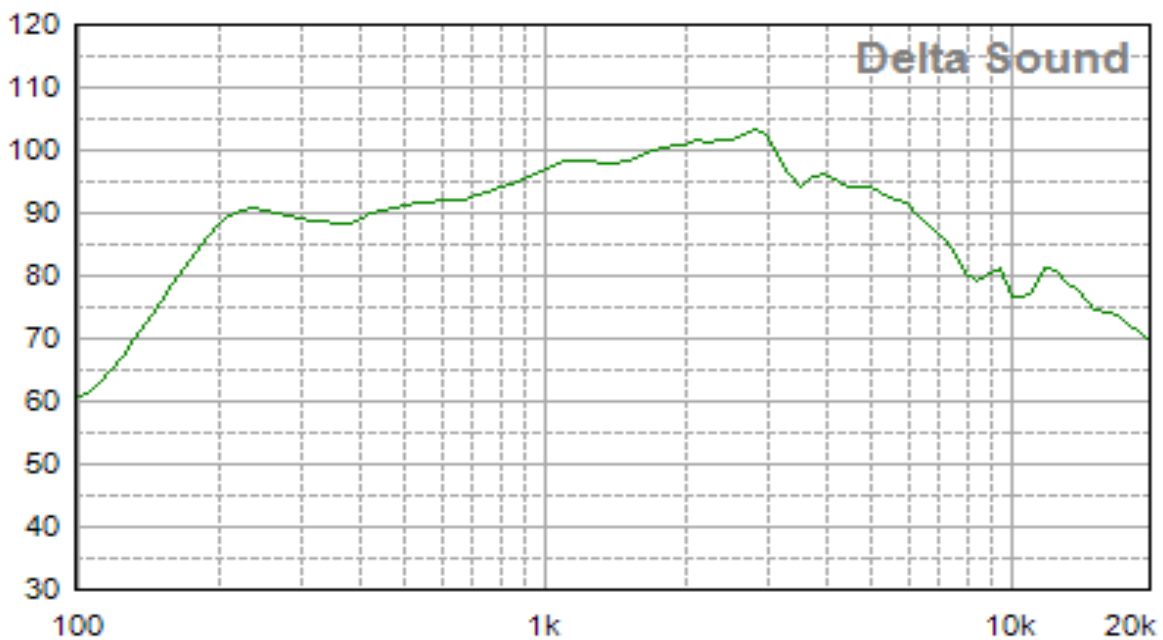

# Specification for Speaker

Model No. VS87x87R4F300P5

Drawing No.

VS201911280912

Dimensions:

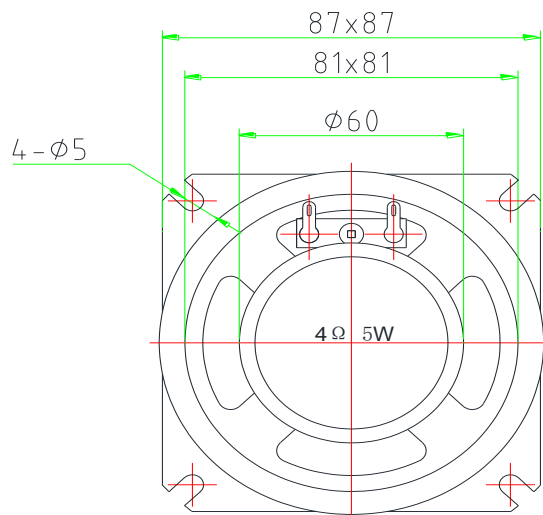
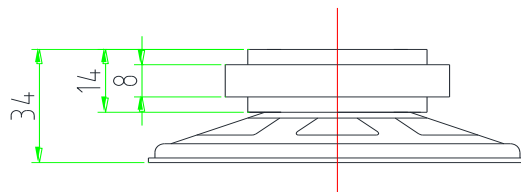
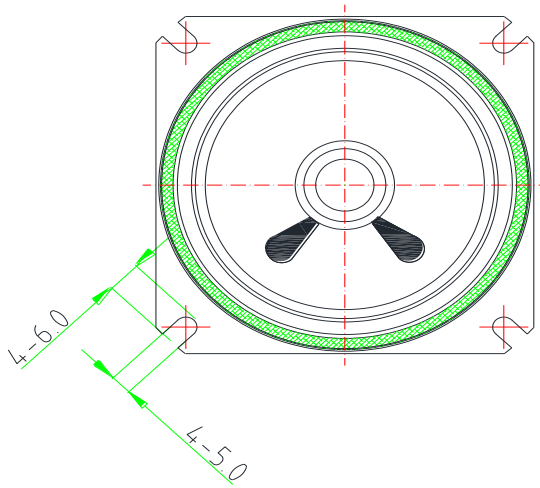

Unit : mm

Tolerance :  $\pm 0.2$