

Features

- Low profile - typical height 1.1 mm
- Low forward voltage drop
- Low leakage current
- Moisture sensitivity: level 1, per J-STD-020
- High temperature soldering guaranteed: 260°C/10 seconds
- Halogen-free according to IEC 61249-2-21 definition

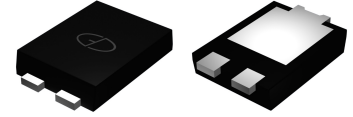

Package:
eSGC (TO-277)

Applications

For low voltage high frequency inverters, DC/DC converters and polarity protection applications.

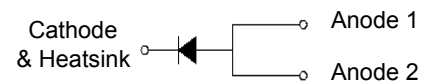

Schematic Diagram

Maximum Ratings ($T_A = 25^\circ\text{C}$ unless otherwise noted)

Parameter	Symbol	Value	Unit
Maximum Repetitive Peak Reverse Voltage	V_{RRM}	100	V
Maximum RMS Voltage	V_{RMS}	70	V
Maximum DC Blocking Voltage	V_{DC}	100	V
Maximum Average Forward Rectified Current	$I_{F(AV)}$	5.0	A
Peak Forward Surge Current (8.3ms single half sine-wave superimposed on rated load)	I_{FSM}	175	A
Operating Junction and Storage Temperature Range	T_J, T_{STG}	-55 to +150	$^\circ\text{C}$

Electrical Characteristics ($T_A = 25^\circ\text{C}$ unless otherwise noted)

Parameter	Test Conditions	Symbol	Typ.	Max.	Unit		
Maximum Instantaneous Forward Voltage	$I_F=1\text{A}$	$T_A=25^\circ\text{C}$	V_F	0.51	0.55	V	
				$I_F=2\text{A}$	0.58		0.65
					$I_F=5\text{A}$		0.70
	$I_F=1\text{A}$	$T_A=85^\circ\text{C}$		0.45	0.50		
				$I_F=2\text{A}$	0.53		0.60
				$I_F=5\text{A}$	0.62		0.68
	$I_F=1\text{A}$	$T_A=125^\circ\text{C}$		0.40	0.45		
				$I_F=2\text{A}$	0.47		0.55
				$I_F=5\text{A}$	0.56		0.62
Maximum DC Reverse Current at Rated DC Blocking Voltage	Rated V_R	I_R	$T_A=25^\circ\text{C}$	0.05	0.1	mA	
			$T_A=85^\circ\text{C}$	0.2	1		
			$T_A=125^\circ\text{C}$	1	20		
Junction Capacitance	4.0 V, 1 MHz	C_J	265		pF		
Typical Thermal Resistance	Junction to Lead	$R_{\theta JL}$	60		$^\circ\text{C/W}$		

Ratings and Characteristics Curves ($T_A = 25^\circ\text{C}$ unless otherwise noted)

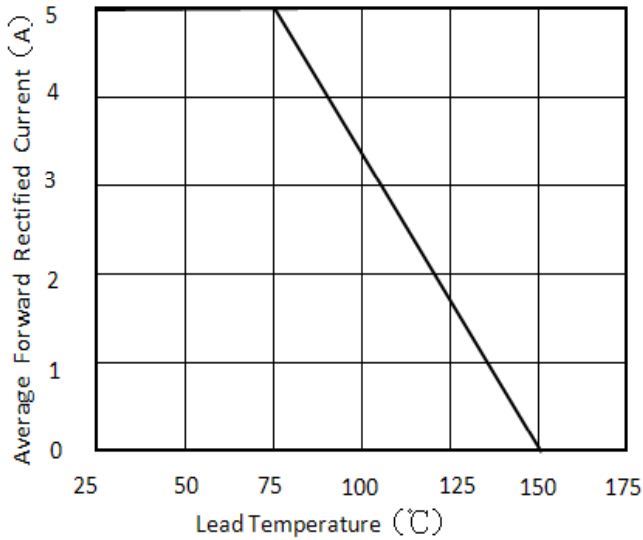

Figure 1. Forward Current Derating Curve

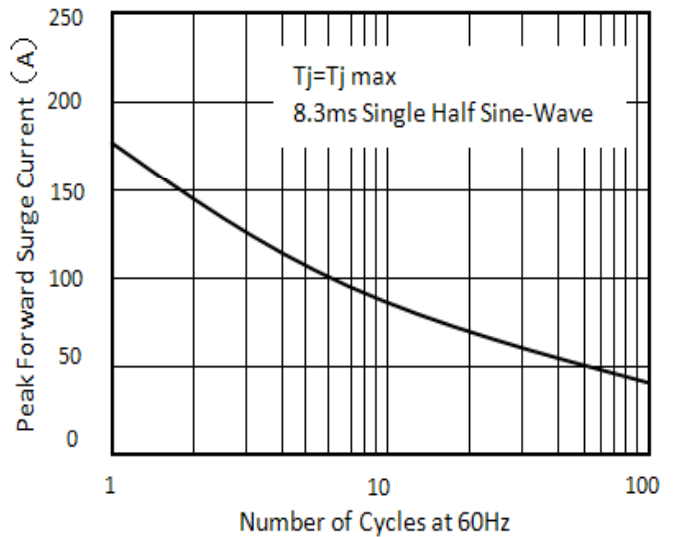

Figure 2. Maximum Non-Repetitive Peak Forward Surge Current

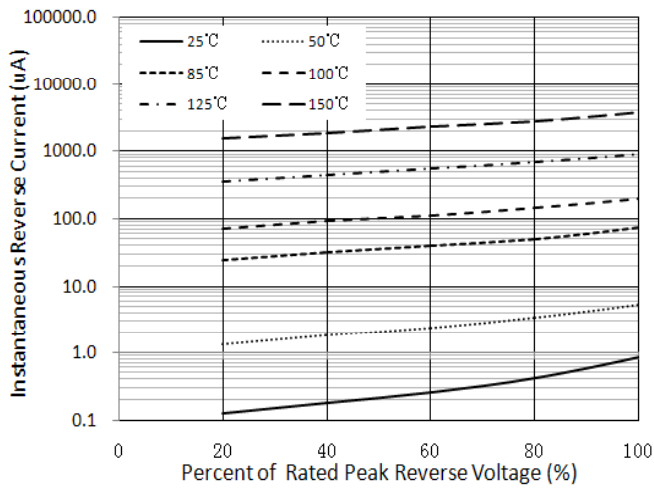

Figure 3. Typical Reverse Characteristics

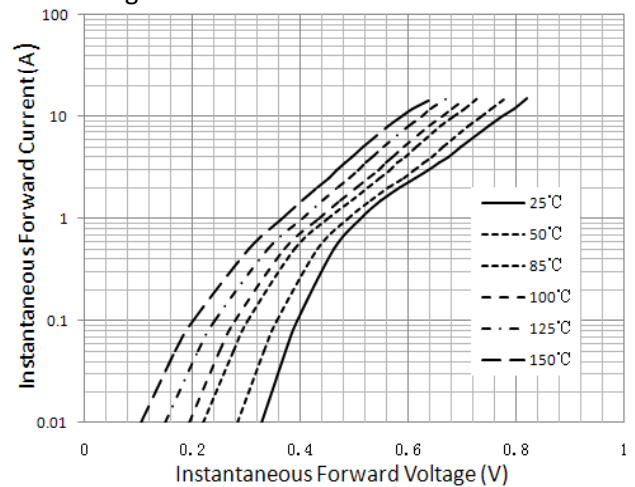

Figure 4. Typical Instantaneous Forward Characteristics

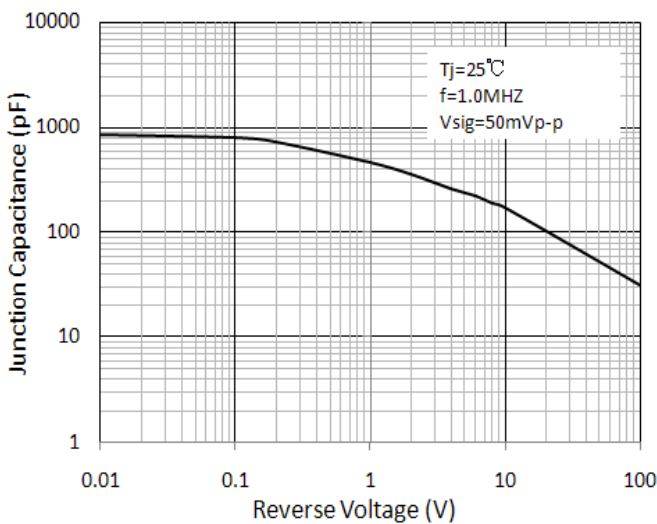
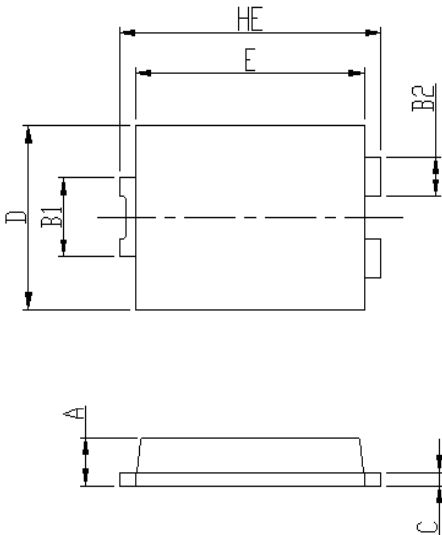

Figure 5. Typical Junction Capacitance

Package Outline Dimensions

eSGC (TO-277)



DIM	Unit: mm		Unit: inch	
	MIN	MAX	MIN	MAX
HE	6.4	6.6	0.252	0.260
E	5.6	5.8	0.220	0.228
D	4.1	4.3	0.161	0.169
B1	1.7	1.9	0.067	0.075
B2	0.8	1	0.031	0.039
A	1.05	1.2	0.041	0.047
C	0.3	0.4	0.012	0.016
L	0.85	1.1	0.033	0.043
L1	4.2	4.4	0.165	0.173
L2	3.52 Typ.		0.139 Typ.	
L3	1.1	1.4	0.043	0.055
D1	3	3.3	0.118	0.130
E1	1.86 Typ.		0.073 Typ.	

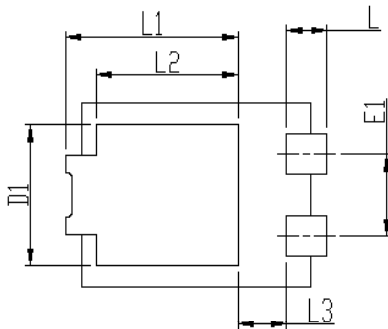

Soldering footprint

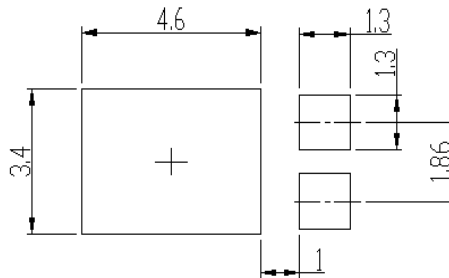

Packing Information

Packing quantities

5000 pcs/Reel, 12 mm Tape, 13" Reel

Tape & Reel Specification

