0.8%ACCURACY 0.7V OUTPUT 400mA LDO REGULATOR

NO.EA-180-200325

OUTLINE

The RP106x Series are low voltage 400mA voltage regulator. These ICs had been further improved of low-voltage capability compared with previous low-voltage product.

The input voltage is as low as Min. 1.0V and the output voltage can be set from 0.7V. The output voltage accuracy has been improved to $\pm 0.8\%$ and due to a built-in transistor with low on-resistance of 0.55Ω (at $V_{OUT}=1.5V$).

Each of these ICs consists of a voltage reference unit, an error amplifier, a resistor-net for voltage setting, and a current limit circuits for over-current for the destruction prevention by the over-current.

The CE pin can switch the regulator to standby mode. In addition to SOT-23-5 and SC-88A packages, a 0.69mm square WLCSP-4-P5 package and a 1.2mm square DFN(PLP)1212-6 are also available.

FEATURES

- Supply Current Typ. 48 μ A
- Supply Current (Standby)..... Typ. 0.1 μ A
- Ripple Rejection Typ. 60dB (f=10kHz)
- Input Voltage Range 1.0V to 3.6V
- Output Voltage Range.....0.7V to 1.8V (0.1V steps)
(For other voltages, please refer to MARK INFORMATION.)
- Output Voltage Accuracy..... $\pm 0.8\%$ ($V_{OUT}\geq 1.0V$, $T_{opt}=25^{\circ}C$)
- Temperature-Drift Coefficient of Output Voltage ... Typ. $\pm 60ppm/^{\circ}C$
- Dropout Voltage Typ. 0.22V ($V_{OUT}=1.5V$)
- Line Regulation Typ. 0.10%/V
- Packages WLCSP-4-P5, DFN(PLP)1212-6, SC-88A, SOT-23-5
- Built-in Fold Back Protection Circuit Typ. 110mA (Current at short mode)
- Built-in Constant Slope Circuit
- Ceramic capacitors are recommended to be used with this IC1.0 μ F or more

APPLICATIONS

- Power source for portable communication equipment.
- Power source for electrical appliances such as cameras, VCRs and camcorders.
- Power source for battery-powered equipment.

RP106x

NO.EA-180-200325

BLOCK DIAGRAMS

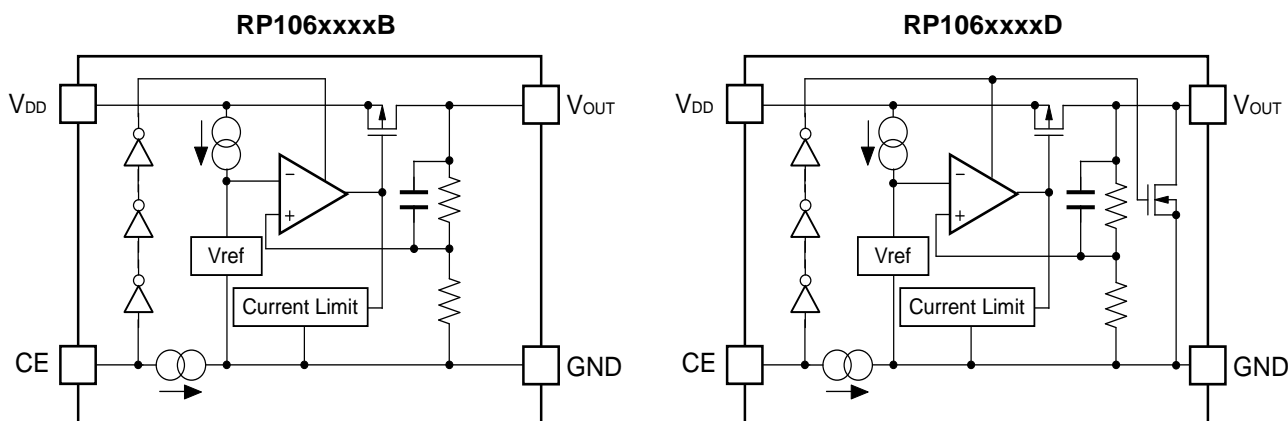

SELECTION GUIDE

The output voltage, auto discharge function, package, and the taping type, etc. for the ICs can be selected at the user's request.

Product Name	Package	Quantity per Reel	Pb Free	Halogen Free
RP106Zxx1*-TR-F	WLCSP-4-P5	5,000 pcs	Yes	Yes
RP106Kxx1*-TR	DFN(PLP)1212-6	5,000 pcs	Yes	Yes
RP106Qxx2*-TR-FE	SC-88A	3,000 pcs	Yes	Yes
RP106Nxx1*-TR-FE	SOT-23-5	3,000 pcs	Yes	Yes

xx : Setting Output Voltage (V_{OUT}) :

Fixed Type: 07 to 18 Stepwise setting with 0.1V increment in the range from 0.7V to 1.8V

Exception: 1.25V=RP106x12x*5-xx

1.85V=RP106x18x*5-xx

* : Designation of Active Type:

B:"H" Active, without auto discharge function at off state.

D:"H" Active, with auto discharge function at off state.

PIN CONFIGURATIONS

• WLCSP-4-P5

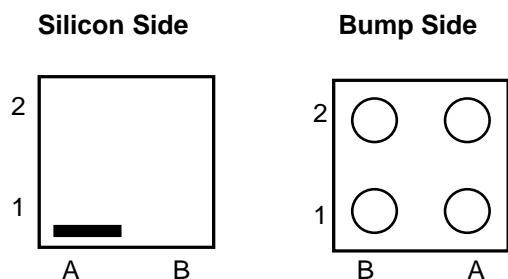

• DFN(PLP)1212-6

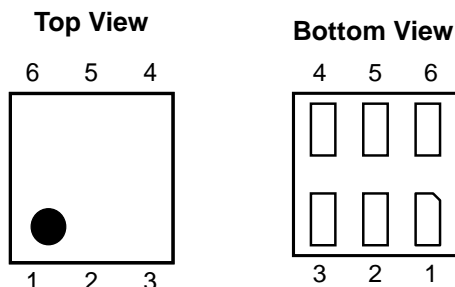

• SC-88A

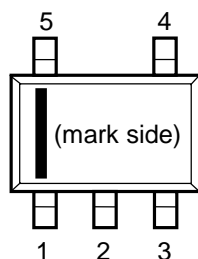

• SOT-23-5

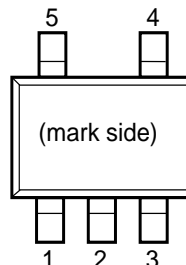

PIN DESCRIPTIONS

• WLCSP-4-P5

Pin No.	Symbol	Description
A1	V_{DD}	Input Pin
A2	V_{OUT}	Output Pin
B1	CE	Chip Enable Pin ("H" Active)
B2	GND	Ground Pin

• DFN(PLP)1212-6

Pin No.	Symbol	Description
1	NC	No Connection
2	GND	Ground Pin
3	CE	Chip Enable Pin ("H" Active)
4	V_{DD}	Input Pin
5	NC	No Connection
6	V_{OUT}	Output Pin

• SC-88A

Pin No.	Symbol	Description
1	CE	Chip Enable Pin ("H" Active)
2*	NC	No Connection
3	GND	Ground Pin
4	V_{OUT}	Output Pin
5	V_{DD}	Input Pin

• SOT-23-5

Pin No.	Symbol	Description
1	V_{DD}	Input Pin
2	GND	Ground Pin
3	CE	Chip Enable Pin ("H" Active)
4	NC	No Connection
5	V_{OUT}	Output Pin

* Pin No. 2 is connected to the bottom of the IC.
It is recommended that the pin be connected to the ground plane on the board, or otherwise be left floating so that there is no contact with other potentials.

* RP106N (SOT-23-5) is the discontinued product as of March 2020.

RP106x

NO.EA-180-200325

ABSOLUTE MAXIMUM RATINGS

Symbol	Item	Rating	Unit
V_{IN}	Input Voltage	4.0	V
V_{CE}	Input Voltage (CE Pin)	-0.3 to 4.0	V
V_{OUT}	Output Voltage	-0.3 to $V_{IN}+0.3$	V
I_{OUT}	Output Current	500	mA
P_D	Power Dissipation (WLCSP-4-P5)*	278	mW
	Power Dissipation (DFN(PLP)1212-6)*	400	
	Power Dissipation (SC-88A)*	380	
	Power Dissipation (SOT-23-5)*	420	
T_{opt}	Operating Temperature Range	-40 to 85	°C
T_{stg}	Storage Temperature Range	-55 to 125	°C

*) For Power Dissipation, please refer to PACKAGE INFORMATION.

ABSOLUTE MAXIMUM RATINGS

Electronic and mechanical stress momentarily exceeded absolute maximum ratings may cause permanent damage and may degrade the life time and safety for both device and system using the device in the field. The functional operation at or over these absolute maximum ratings is not assured.

ELECTRICAL CHARACTERISTICS

• RP106x

$V_{IN} = \text{Set } V_{OUT} + 1V$, $I_{OUT} = 1mA$, $C_{IN} = C_{OUT} = 1\mu F$, unless otherwise noted.

The specifications surrounded by are guaranteed by Design Engineering at $-40^{\circ}C \leq T_{opt} \leq 85^{\circ}C$.

$T_{opt} = 25^{\circ}C$

Symbol	Item	Conditions	Min.	Typ.	Max.	Unit	
V_{OUT}	Output Voltage	$T_{opt} = 25^{\circ}C$	$V_{OUT} \geq 1.0V$	$\times 0.992$		$\times 1.008$	V
			$V_{OUT} < 1.0V$	-8		8	mV
		$-40^{\circ}C \leq T_{opt} \leq 85^{\circ}C$	$V_{OUT} \geq 1.0V$	×0.983		×1.017	V
			$V_{OUT} < 1.0V$	-17		17	mV
I_{OUT}	Output Current		400			mA	
$\Delta V_{OUT} / \Delta I_{OUT}$	Load Regulation	$1mA \leq I_{OUT} \leq 400mA$		25	45	mV	
V_{DIF}	Dropout Voltage	Refer to the following table					
I_{SS}	Supply Current	$I_{OUT} = 0mA$		48	75	μA	
$I_{standby}$	Supply Current (Standby)	$V_{CE} = 0V$		0.1	8.0	μA	
$\Delta V_{OUT} / \Delta V_{IN}$	Line Regulation	Set $V_{OUT} + 0.5V \leq V_{IN} \leq 3.6V$ In case that Set $V_{OUT} < 0.8V$, $1.3V \leq V_{IN} \leq 3.6V$		0.10	0.25	%/V	
RR	Ripple Rejection	$f = 10kHz$, Ripple 0.2Vp-p $V_{IN} = \text{Set } V_{OUT} + 1V$, $I_{OUT} = 30mA$		60		dB	
V_{IN}	Input Voltage		1.0		3.6	V	
$\Delta V_{OUT} / \Delta T_{opt}$	Output Voltage Temperature Coefficient	$-40^{\circ}C \leq T_{opt} \leq 85^{\circ}C$		± 60		ppm/ $^{\circ}C$	
I_{SC}	Short Current Limit	$V_{OUT} = 0V$		110		mA	
I_{PD}	CE Pull-down Current			0.38	0.7	μA	
V_{CEH}	CE Input Voltage "H"		0.9			V	
V_{CEL}	CE Input Voltage "L"				0.4	V	
en	Output Noise	BW=10Hz to 100kHz $I_{OUT} = 30mA$, $V_{OUT} = 0.7V$		30		μV_{rms}	
R_{LOW}	Low Output Nch Tr. ON Resistance (of D version)	$V_{IN} = 2.0V$, $V_{CE} = 0V$		43		Ω	

All test items listed under Electrical Characteristics are done under the pulse load condition ($T_j \approx T_a = 25^{\circ}C$) except Output Noise, Ripple Rejection and Output Voltage Temperature Coefficient items.

* RP106N (SOT-23-5) is the discontinued product as of March 2020.

RP106x

NO.EA-180-200325

The specifications surrounded by are guaranteed by Design Engineering at $-40^{\circ}\text{C} \leq T_{\text{opt}} \leq 85^{\circ}\text{C}$.

• Dropout Voltage by Output Voltage

$T_{\text{opt}}=25^{\circ}\text{C}$

Output Voltage V_{OUT} (V)	Dropout Voltage V_{DIF} (V)		
	Condition	Typ.	Max.
$0.7 \leq V_{\text{OUT}} < 0.8$	$I_{\text{OUT}}=400\text{mA}$	0.48	0.62
$0.8 \leq V_{\text{OUT}} < 0.9$		0.40	0.54
$0.9 \leq V_{\text{OUT}} < 1.0$		0.36	0.47
$1.0 \leq V_{\text{OUT}} < 1.2$		0.32	0.45
$1.2 \leq V_{\text{OUT}} < 1.5$		0.28	0.38
$1.5 \leq V_{\text{OUT}}$		0.22	0.31

RECOMMENDED OPERATING CONDITIONS (ELECTRICAL CHARACTERISTICS)

All of electronic equipment should be designed that the mounted semiconductor devices operate within the recommended operating conditions. The semiconductor devices cannot operate normally over the recommended operating conditions, even if they are used over such conditions by momentary electronic noise or surge. And the semiconductor devices may receive serious damage when they continue to operate over the recommended operating conditions.

TYPICAL APPLICATION

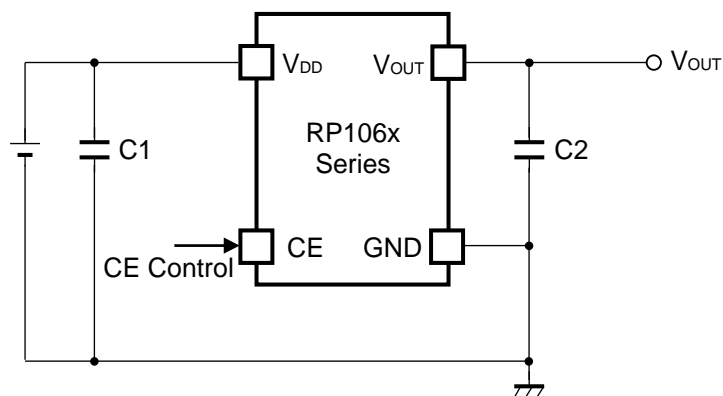

(External Components)

C1, C2 Ceramic 1.0 μ F MURATA: GRM155B31A105KE15

TECHNICAL NOTES

When using these ICs, consider the following points:

Phase Compensation

In these ICs, phase compensation is made for securing stable operation even if the load current is varied. For this purpose, use a capacitor C2 with 1.0 μ F or more.

If a tantalum capacitor is used, and its ESR (Equivalent Series Resistance) of C2 is large, the loop oscillation may result. Because of this, select C2 carefully considering its frequency characteristics.

PCB Layout

Make V_{DD} and GND lines sufficient. If their impedance is high, noise pickup or unstable operation may result. Connect a capacitor C1 with a capacitance value as much as 1.0 μ F or more between V_{DD} and GND pin, and as close as possible to the pins.

Set external components, especially the output capacitor C2, as close as possible to the ICs, and make wiring as short as possible.

Impedance of Input pin

CE pull-down constant current circuit is built in the RP106x.

However, if the CE pin is floating and the wiring is long, the malfunction may occur by noise. Therefore, fully evaluation on the actual PCB is necessary.

RP106x

NO.EA-180-200325

CONSTANT SLOPE CIRCUITS

The RP106x Series is equipped with a constant slope circuit as a soft-start circuit, which allows the output voltage to start up gradually when the CE is turned on.

The constant slope circuit minimizes the inrush current at the start-up and also prevents the overshoot of the output voltage.

The capacitor to create the start-up slope is built in the IC that does not require any external components. The start-up time and the start-up slope angle are fixed inside the IC. For more details, please refer to the graph 15 of "Inrush Current Characteristics Example".

Inrush Current Characteristics Example (C1=1.0μF, T_{opt}=25°C)

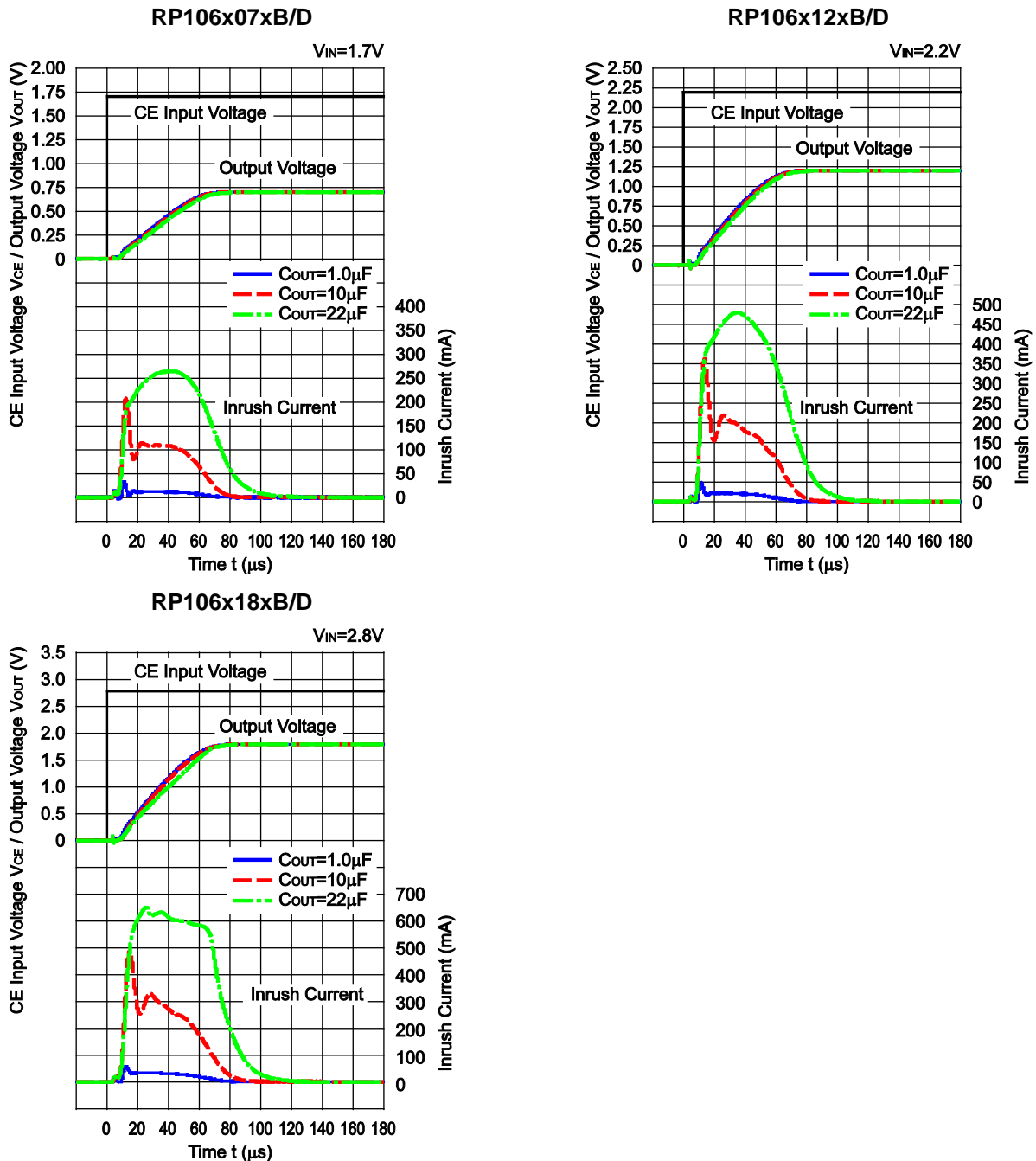

PACKAGE INFORMATION

• Power Dissipation (WLCSP-4-P5)

Power Dissipation (P_D) depends on conditions of mounting on board. This specification is based on the measurement at the condition below:

* Measurement Conditions

	Standard Land Pattern
Environment	Mounting on Board (Wind velocity=0m/s)
Board Material	Glass cloth epoxy plastic (Double sided)
Board Dimensions	40mm × 40mm × 1.6mm
Copper Ratio	Top side : Approx. 50% , Back side : Approx. 50%
Through-hole	φ 0.5mm × 28pcs

* Measurement Result (Ta=25°C, Tjmax=125°C)

	Standard Land Pattern
Power Dissipation	278mW
Thermal Resistance	$\theta_{ja} = (125-25^\circ\text{C})/0.278\text{W} = 360^\circ\text{C/W}$
	$\theta_{jc} = 46^\circ\text{C/W}$

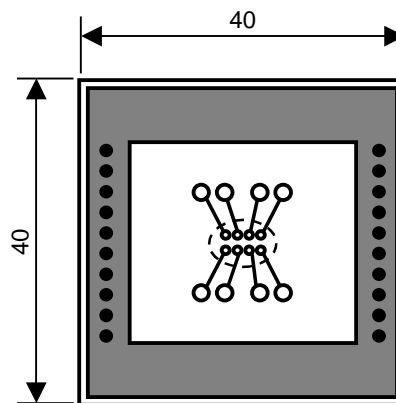
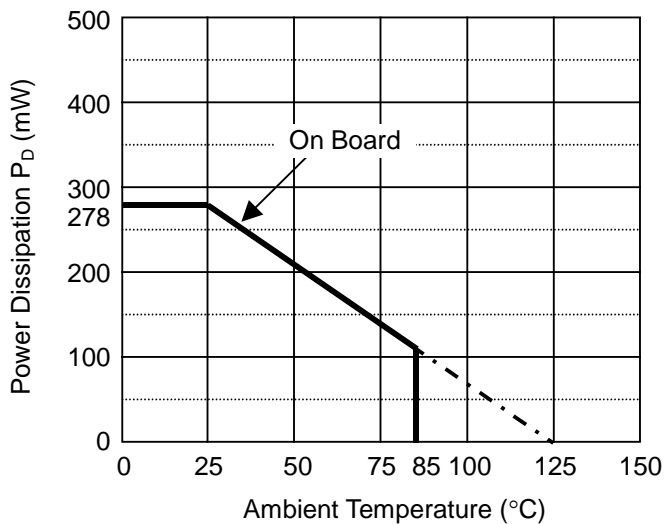

Measurement Board Pattern

○ IC Mount Area (Unit : mm)

* RP106N (SOT-23-5) is the discontinued product as of March 2020.

RP106x

NO.EA-180-200325

• Package Dimensions (WLCSP-4-P5)

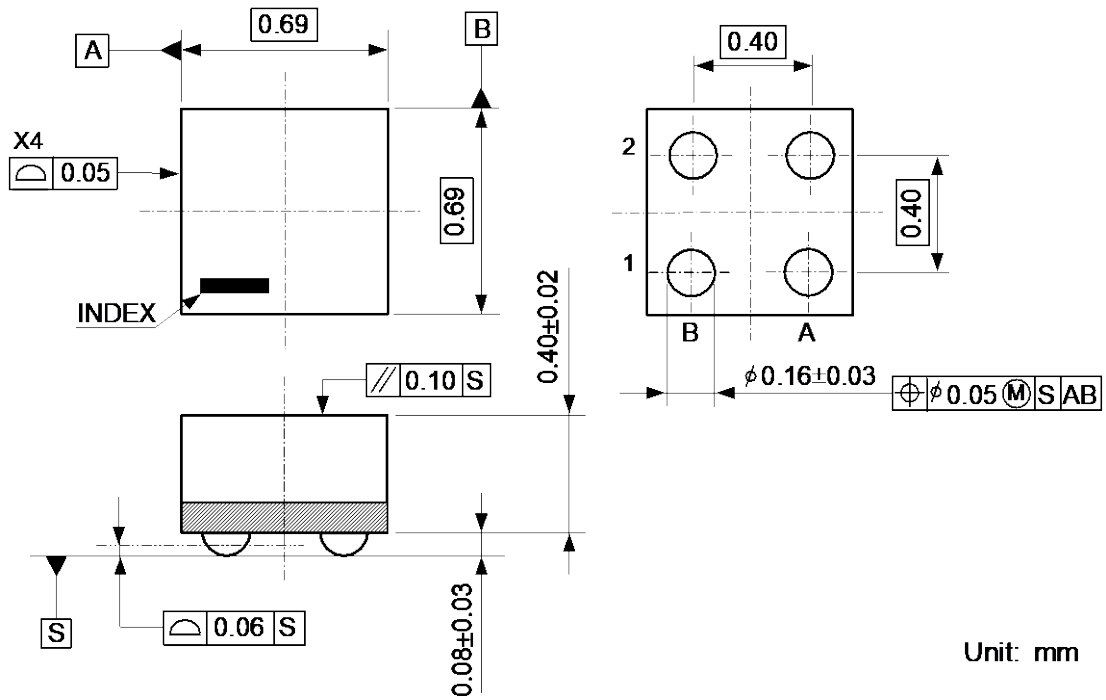

• Mark Specification (WLCSP-4-P5)

①② : Lot No. Alphnumeric serial number.

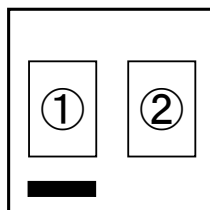

* RP106N (SOT-23-5) is the discontinued product as of March 2020.

RP106x

NO.EA-180-200325

● **RP106Z Series marking list table (WLCSP-4-P5)**

RP106ZxxxB		RP106ZxxxD	
Product Name	V _{SET}	Product Name	V _{SET}
RP106Z071B	0.7V	RP106Z071D	0.7V
RP106Z081B	0.8V	RP106Z081D	0.8V
RP106Z091B	0.9V	RP106Z091D	0.9V
RP106Z101B	1.0V	RP106Z101D	1.0V
RP106Z111B	1.1V	RP106Z111D	1.1V
RP106Z121B	1.2V	RP106Z121D	1.2V
RP106Z131B	1.3V	RP106Z131D	1.3V
RP106Z141B	1.4V	RP106Z141D	1.4V
RP106Z151B	1.5V	RP106Z151D	1.5V
RP106Z161B	1.6V	RP106Z161D	1.6V
RP106Z171B	1.7V	RP106Z171D	1.7V
RP106Z181B	1.8V	RP106Z181D	1.8V
RP106Z121B5	1.25V	RP106Z121D5	1.25V
RP106Z181B5	1.85V	RP106Z181D5	1.85V

RP106x

NO.EA-180-200325

• Power Dissipation (DFN(PLP)1212-6)

Power Dissipation (P_D) depends on conditions of mounting on board. This specification is based on the measurement at the condition below:

Measurement Conditions

	Standard Test Land Pattern
Environment	Mounting on Board (Wind velocity=0m/s)
Board Material	Glass cloth epoxy plastic (Double sided)
Board Dimensions	40mm×40mm×1.6mm
Copper Ratio	Top side: Approx. 50%, Back side: Approx. 50%
Through-holes	ϕ 0.54mm×28pcs

Measurement Result

($T_a=25^\circ\text{C}$, $T_{j\text{max}}=125^\circ\text{C}$)

	Standard Test Land Pattern
Power Dissipation	400mW
Thermal Resistance	$\theta_{ja}=(125-25^\circ\text{C})/0.4\text{W}=250^\circ\text{C/W}$
	$\theta_{jc}=67^\circ\text{C/W}$

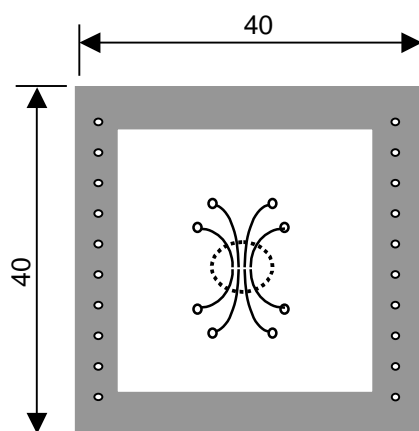
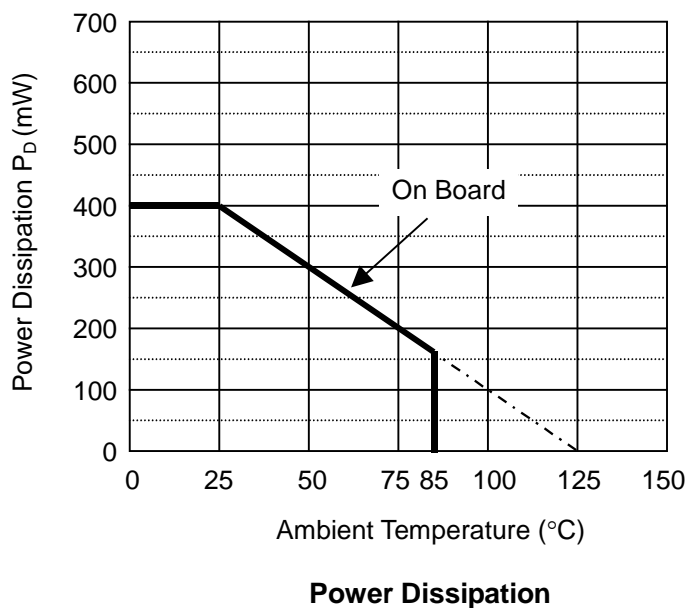

Measurement Board Pattern

○ IC Mount Area Unit : mm

• **Package Dimensions (DFN(PLP)1212-6)**

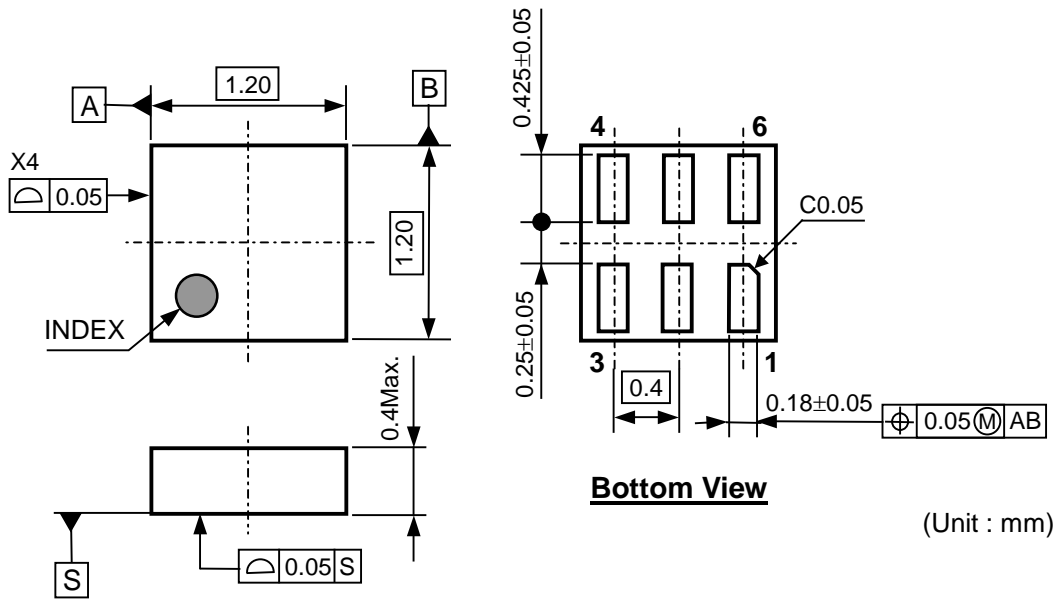

• **Mark Specification (DFN(PLP)1212-6)**

- ①② : Product Code..... Refer to the marking list table
- ③④ : Lot No..... Alphanumeric serial number.

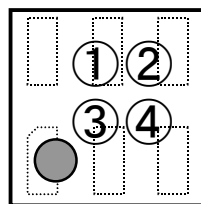

* RP106N (SOT-23-5) is the discontinued product as of March 2020.

RP106x

NO.EA-180-200325

● **RP106K Series marking list table (DFN(PLP)1212-6)**

RP106KxxxB

Product Name	①②	V _{SET}
RP106K071B	NA	0.7V
RP106K081B	NB	0.8V
RP106K091B	NC	0.9V
RP106K101B	ND	1.0V
RP106K111B	NE	1.1V
RP106K121B	NF	1.2V
RP106K131B	NG	1.3V
RP106K141B	NH	1.4V
RP106K151B	NJ	1.5V
RP106K161B	NK	1.6V
RP106K171B	NL	1.7V
RP106K181B	NM	1.8V
RP106K121B5	NP	1.25V
RP106K181B5	NQ	1.85V

RP106KxxxD

Product Name	①②	V _{SET}
RP106K071D	PA	0.7V
RP106K081D	PB	0.8V
RP106K091D	PC	0.9V
RP106K101D	PD	1.0V
RP106K111D	PE	1.1V
RP106K121D	PF	1.2V
RP106K131D	PG	1.3V
RP106K141D	PH	1.4V
RP106K151D	PJ	1.5V
RP106K161D	PK	1.6V
RP106K171D	PL	1.7V
RP106K181D	PM	1.8V
RP106K121D5	PP	1.25V
RP106K181D5	PQ	1.85V

● **Power Dissipation (SC-88A)**

Power Dissipation (P_D) depends on conditions of mounting on board. This specification is based on the measurement at the condition below;

Measurement Conditions

	Standard Land Pattern
Environment	Mounting on Board (Wind velocity=0m/s)
Board Material	Glass cloth epoxy plastic (Double Layers)
Board Dimensions	40mm×40mm×1.6mm
Copper Ratio	Top side: Approx. 50%, Back side: Approx. 50%
Through-hole	φ0.5mm×44pcs

Measurement Result

($T_a=25^{\circ}\text{C}$, $T_{j\text{max}}=125^{\circ}\text{C}$)

	Standard Land Pattern	Free Air
Power Dissipation	380mW	150mW
Thermal Resistance	$\theta_{ja}=(125-25^{\circ}\text{C})/0.38\text{W}=263^{\circ}\text{C/W}$	$\theta_{ja}=(125-25^{\circ}\text{C})/0.15\text{W}=667^{\circ}\text{C/W}$
	$\theta_{jc}=75^{\circ}\text{C/W}$	-

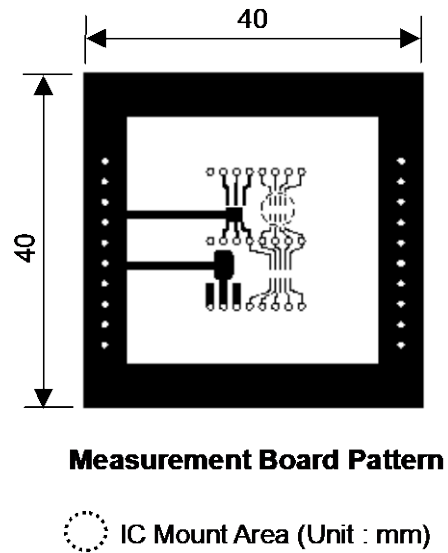
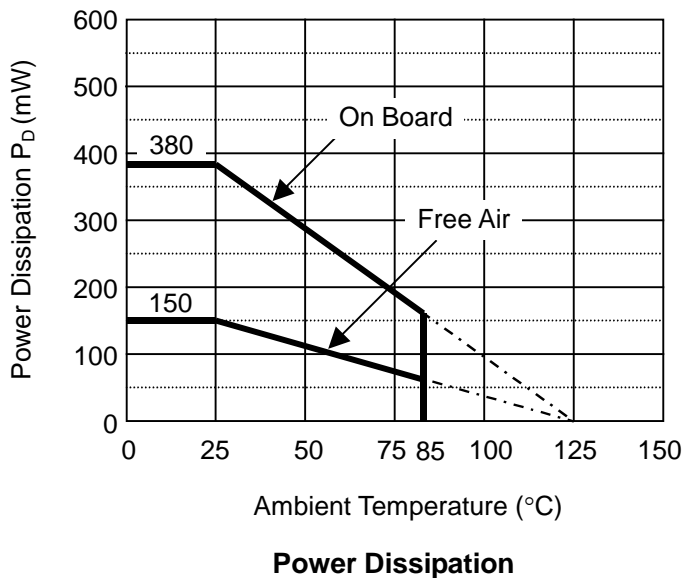

RP106x

NO.EA-180-200325

● **Package Dimensions (SC-88A)**

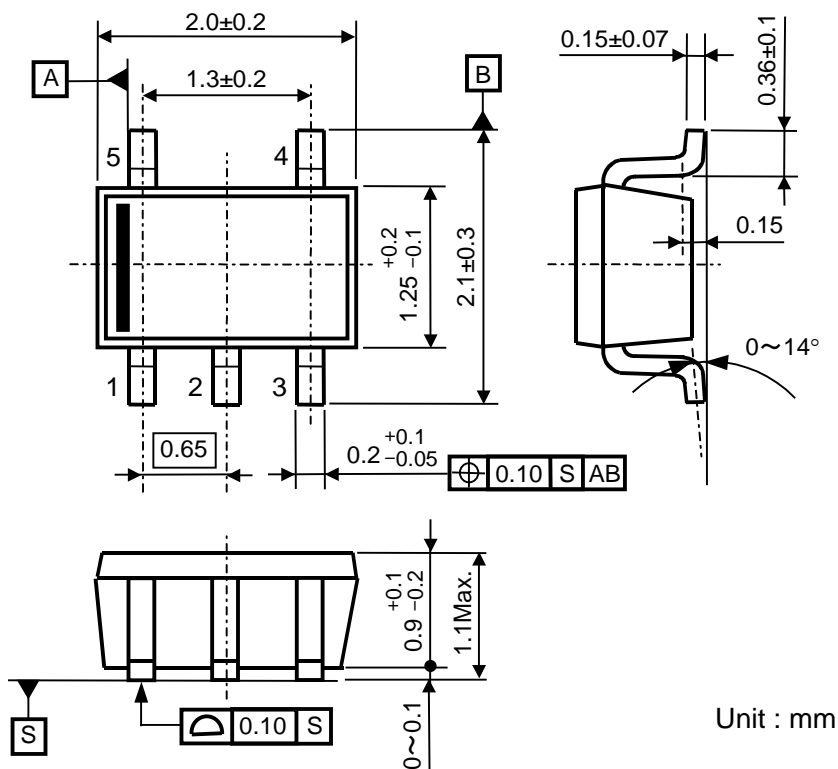

Unit : mm

● **Mark Specification (SC-88A)**

①②③④ : Product Code.....Refer to the marking list table

⑤⑥ : Lot No.....Alphanumeric serial number.

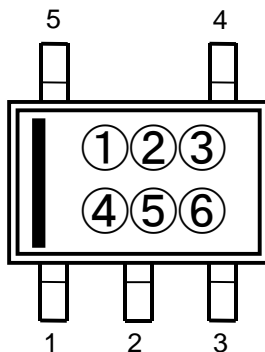

* RP106N (SOT-23-5) is the discontinued product as of March 2020.

RP106x

NO.EA-180-200325

● **RP106Q Series marking list table (SC-88A)**

RP106QxxxB			RP106QxxxD		
Product Name	①②③④	V _{SET}	Product Name	①②③④	V _{SET}
RP106Q072B	Q 0 0 1	0.7V	RP106Q072D	R 0 0 1	0.7V
RP106Q082B	Q 0 0 2	0.8V	RP106Q082D	R 0 0 2	0.8V
RP106Q092B	Q 0 0 3	0.9V	RP106Q092D	R 0 0 3	0.9V
RP106Q102B	Q 0 0 4	1.0V	RP106Q102D	R 0 0 4	1.0V
RP106Q112B	Q 0 0 5	1.1V	RP106Q112D	R 0 0 5	1.1V
RP106Q122B	Q 0 0 6	1.2V	RP106Q122D	R 0 0 6	1.2V
RP106Q132B	Q 0 0 7	1.3V	RP106Q132D	R 0 0 7	1.3V
RP106Q142B	Q 0 0 8	1.4V	RP106Q142D	R 0 0 8	1.4V
RP106Q152B	Q 0 0 9	1.5V	RP106Q152D	R 0 0 9	1.5V
RP106Q162B	Q 0 1 0	1.6V	RP106Q162D	R 0 1 0	1.6V
RP106Q172B	Q 0 1 1	1.7V	RP106Q172D	R 0 1 1	1.7V
RP106Q182B	Q 0 1 2	1.8V	RP106Q182D	R 0 1 2	1.8V
RP106Q122B5	Q 0 1 4	1.25V	RP106Q122D5	R 0 1 4	1.25V
RP106Q182B5	Q 0 1 5	1.85V	RP106Q182D5	R 0 1 5	1.85V

RP106x

NO.EA-180-200325

• Power Dissipation (SOT-23-5)

Power Dissipation (P_D) depends on conditions of mounting on board. This specification is based on the measurement at the condition below:

(Power Dissipation (SOT-23-5) is substitution of SOT-23-6.)

Measurement Conditions

	Standard Test Land Pattern
Environment	Mounting on Board (Wind velocity=0m/s)
Board Material	Glass cloth epoxy plastic (Double sided)
Board Dimensions	40mm×40mm×1.6mm
Copper Ratio	Top side: Approx. 50%, Back side: Approx. 50%
Through-holes	φ 0.5mm×44pcs

Measurement Result

($T_a=25^\circ\text{C}$, $T_{j\text{max}}=125^\circ\text{C}$)

	Standard Land Pattern	Free Air
Power Dissipation	420mW	250mW
Thermal Resistance	$\theta_{ja}=(125-25^\circ\text{C})/0.42\text{W}=238^\circ\text{C/W}$	400°C/W

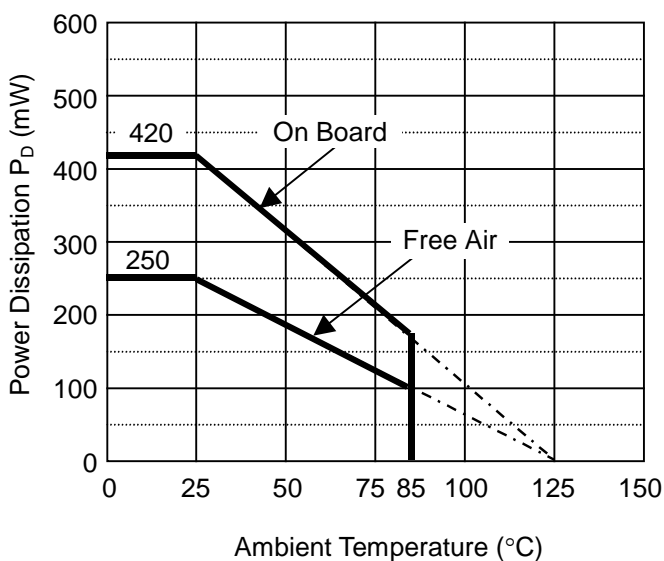

Power Dissipation

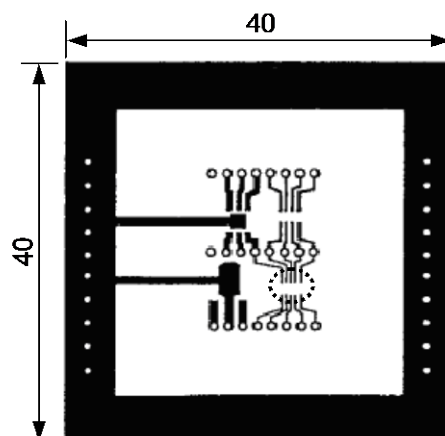

Measurement Board Pattern

○ IC Mount Area (Unit: mm)

● Package Dimensions (SOT-23-5)

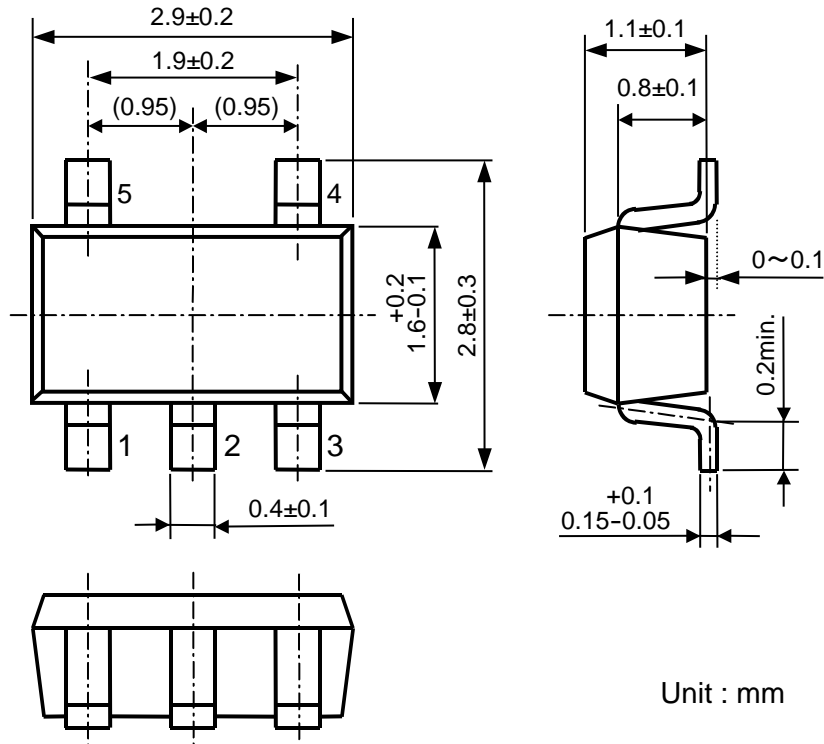

● Mark Specification (SOT-23-5)

①②③ : Product Code.....Refer to the marking list table

④⑤ : Lot No.....Alphanumeric serial number.

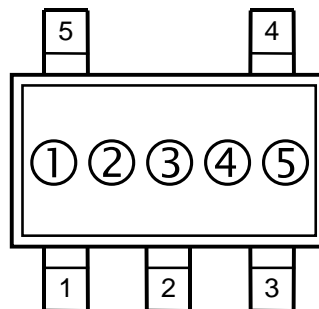

* RP106N (SOT-23-5) is the discontinued product as of March 2020.

RP106x

NO.EA-180-200325

● **RP106N Series marking list table (SOT-23-5)**

RP106NxxxB

Product Name	①②③	V _{SET}
RP106N071B	C A A	0.7V
RP106N081B	C A B	0.8V
RP106N091B	C A C	0.9V
RP106N101B	C A D	1.0V
RP106N111B	C A E	1.1V
RP106N121B	C A F	1.2V
RP106N131B	C A G	1.3V
RP106N141B	C A H	1.4V
RP106N151B	C A J	1.5V
RP106N161B	C A K	1.6V
RP106N171B	C A L	1.7V
RP106N181B	C A M	1.8V
RP106N121B5	C A P	1.25V
RP106N181B5	C A Q	1.85V

RP106NxxxD

Product Name	①②③	V _{SET}
RP106N071D	C B A	0.7V
RP106N081D	C B B	0.8V
RP106N091D	C B C	0.9V
RP106N101D	C B D	1.0V
RP106N111D	C B E	1.1V
RP106N121D	C B F	1.2V
RP106N131D	C B G	1.3V
RP106N141D	C B H	1.4V
RP106N151D	C B J	1.5V
RP106N161D	C B K	1.6V
RP106N171D	C B L	1.7V
RP106N181D	C B M	1.8V
RP106N121D5	C B P	1.25V
RP106N181D5	C B Q	1.85V

TEST CIRCUITS

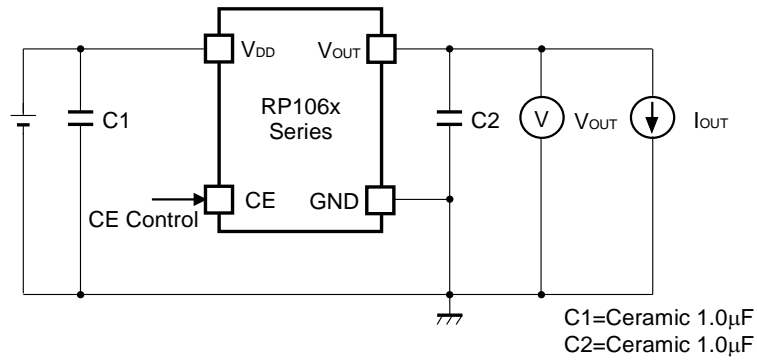

Basic Test Circuit

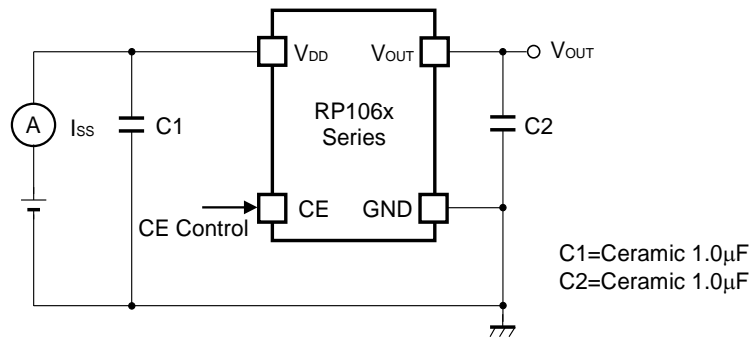

Supply Current Test Circuit

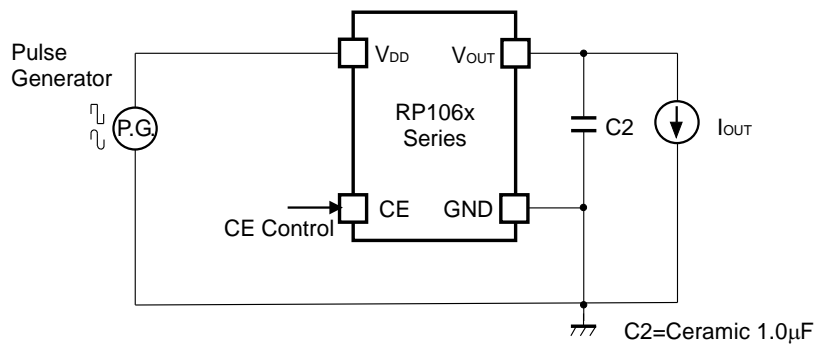

Ripple Rejection Test Circuit

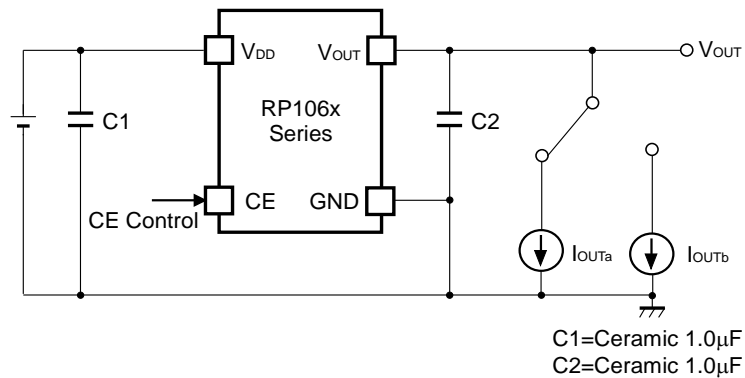

Load Transient Response Test Circuit

RP106x

NO.EA-180-200325

TYPICAL CHARACTERISTICS

1) Output Voltage vs. Output Current ($T_{opt}=25^{\circ}C$)

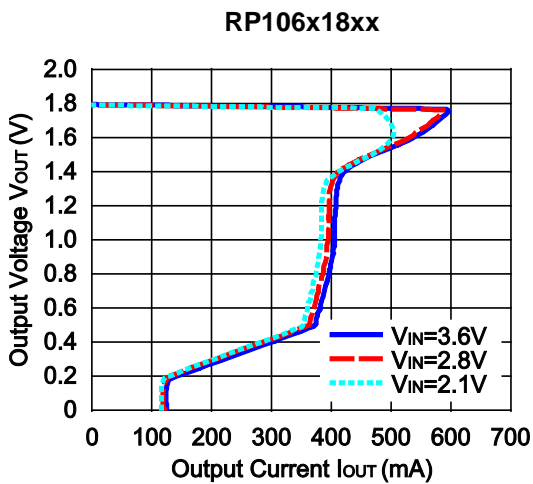
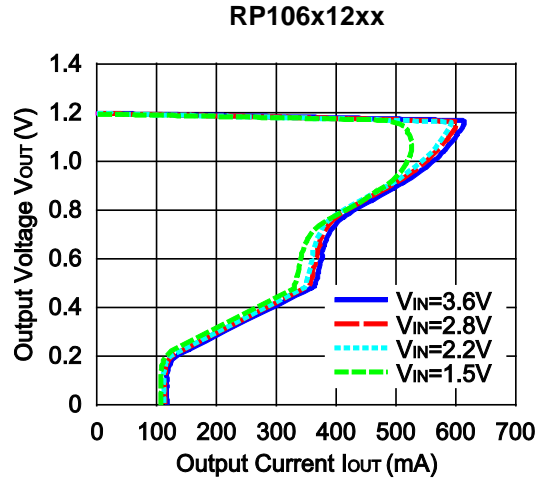
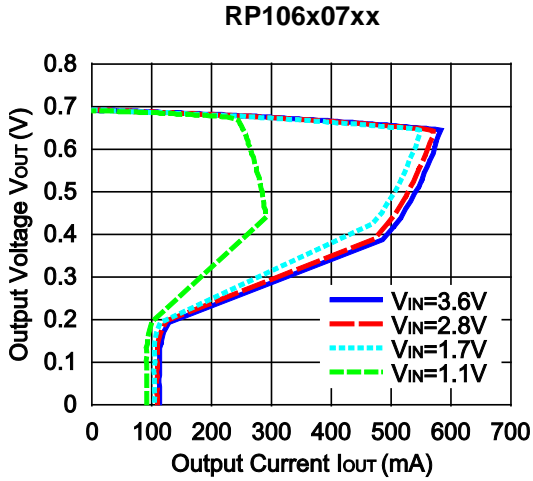

2) Output Voltage vs. Input Voltage ($T_{opt}=25^{\circ}C$)

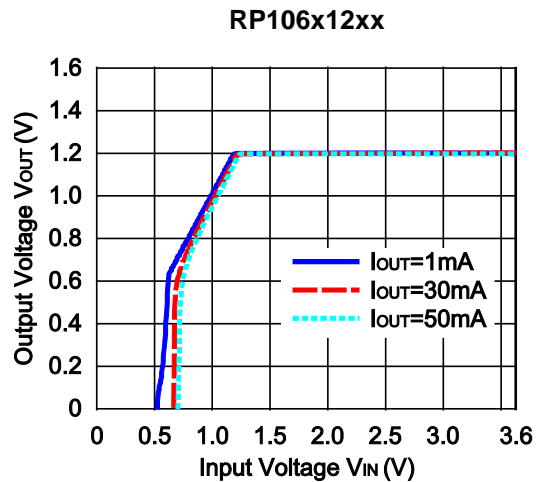
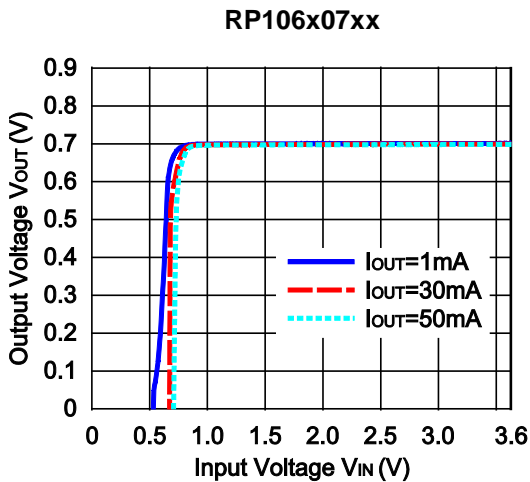

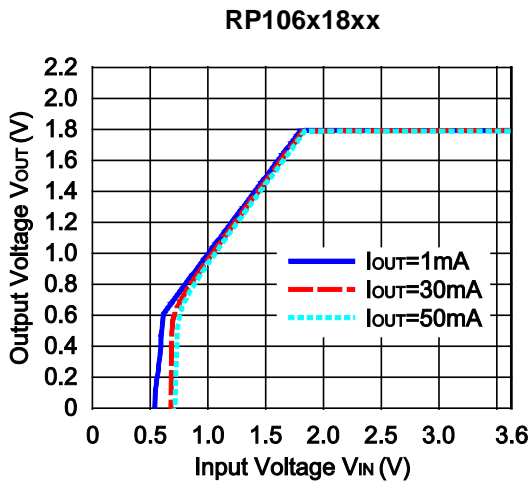

3) Supply Current vs. Input Voltage ($T_{opt}=25^{\circ}C$)

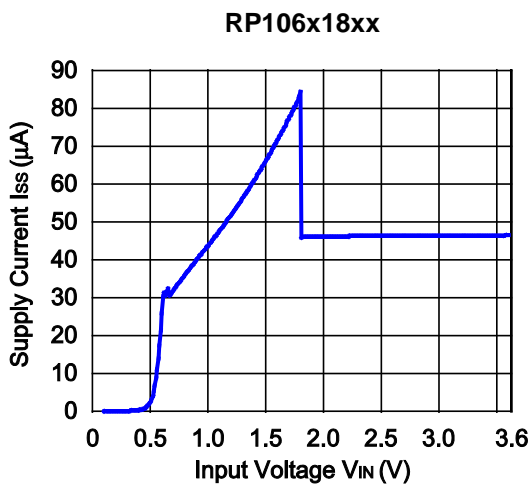
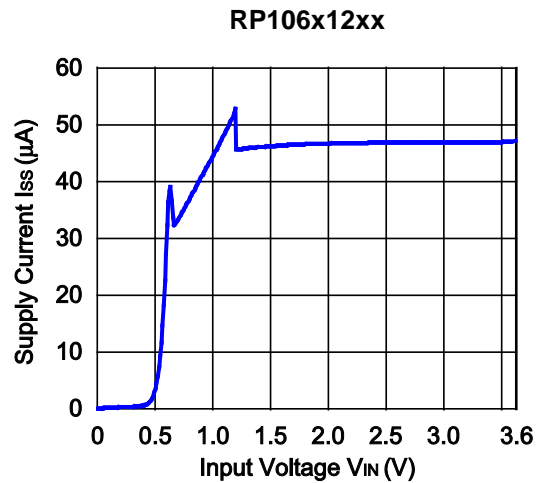
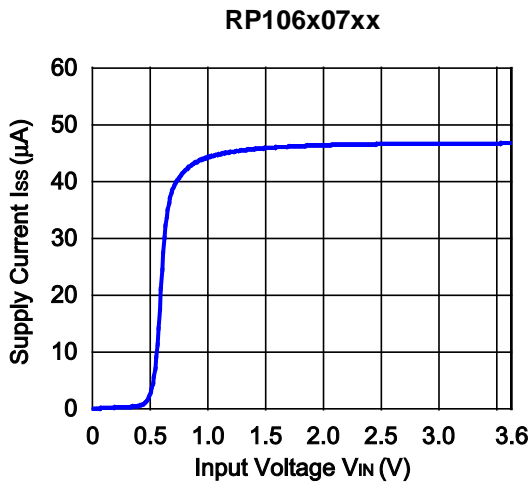

RP106x

NO.EA-180-200325

4) Output Voltage vs. Temperature

RP106x07xx

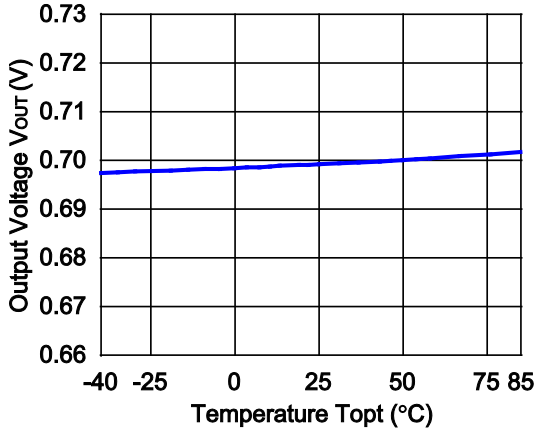

RP106x12xx

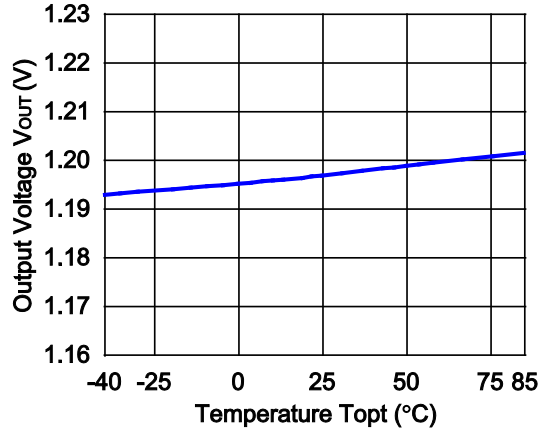

RP106x18xx

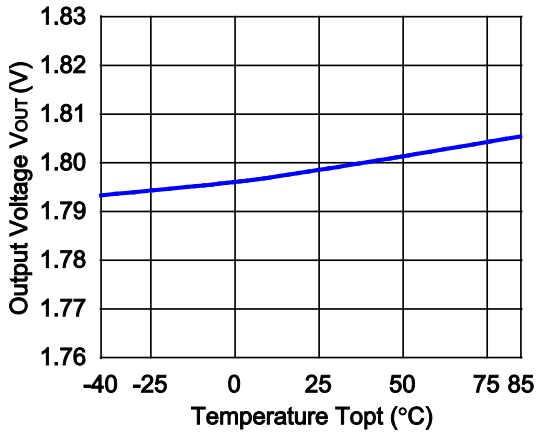

5) Supply Current vs. Temperature

RP106x07xx

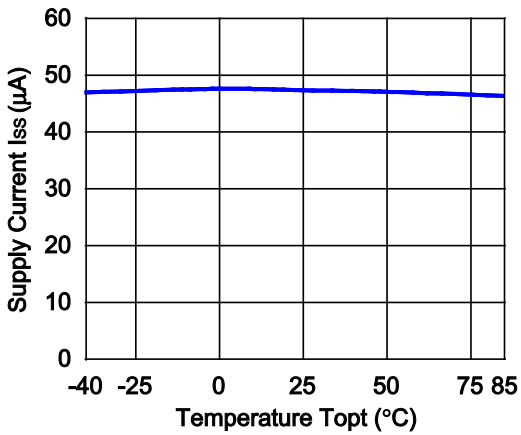

RP106x12xx

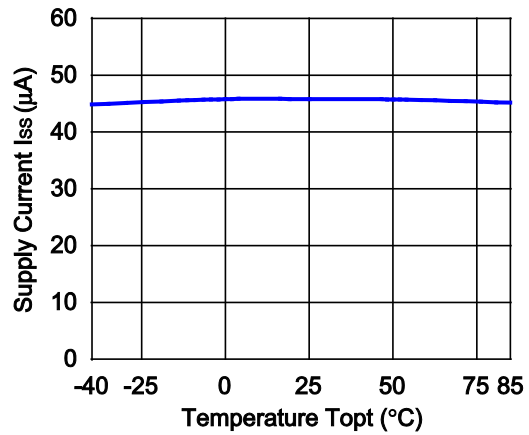

RP106x18xx

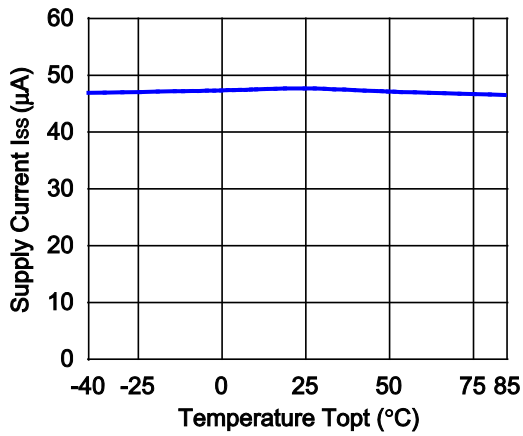

6) Dropout Voltage vs. Output Current

RP106x07xx

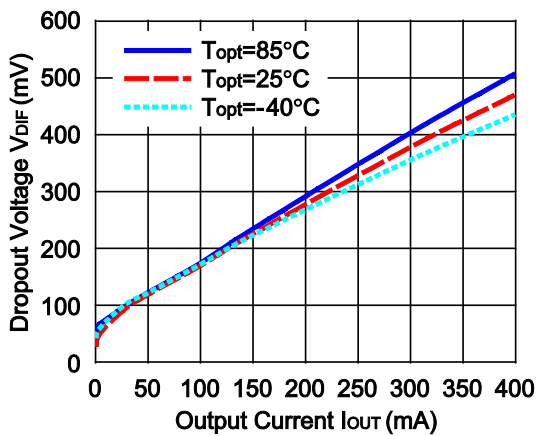

RP106x12xx

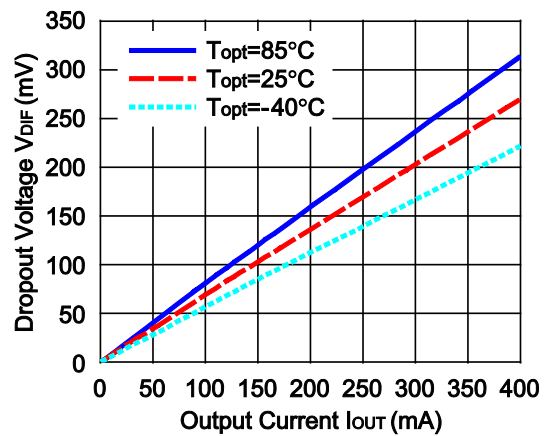

RP106x18xx

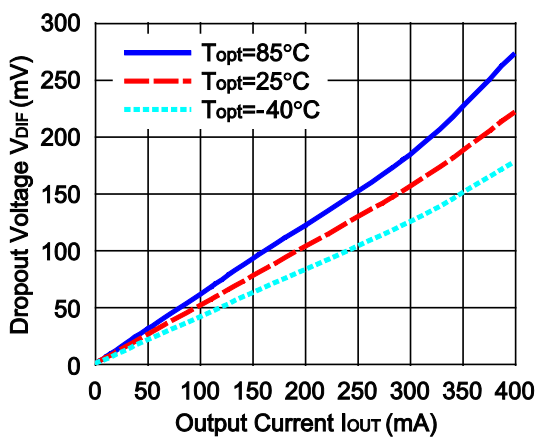

RP106x

NO.EA-180-200325

7) Dropout Voltage vs Set Output Voltage ($T_{opt}=25^{\circ}\text{C}$)

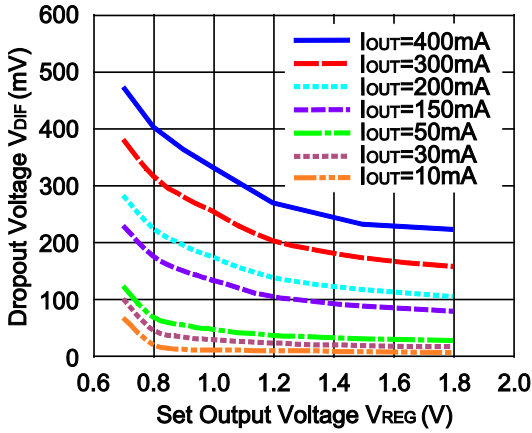

8) Minimum Operating Voltage

RP106x07xx

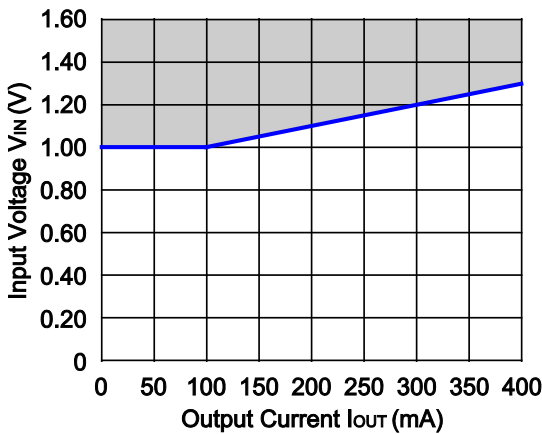

Hatched area is available for 0.7V output

9) Ripple Rejection vs. Input Bias Voltage ($C_1=\text{none}$, $C_2=1.0\mu\text{F}$, Ripple=0.2Vp-p, $T_{opt}=25^{\circ}\text{C}$)

RP106x07xx

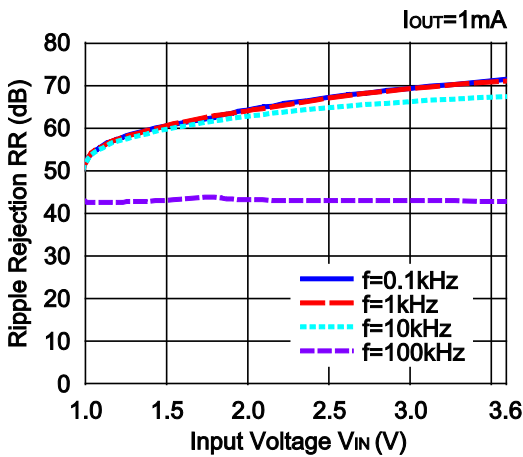

RP106x07xx

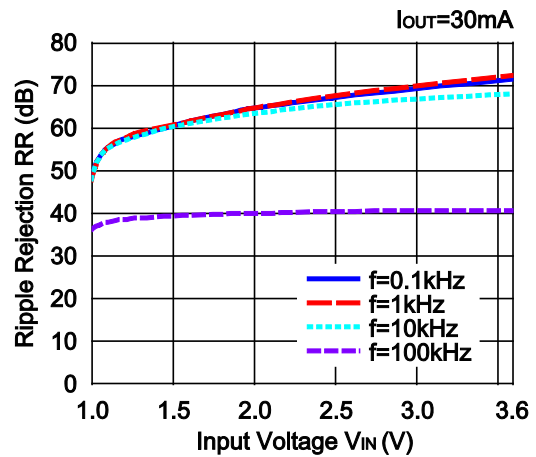

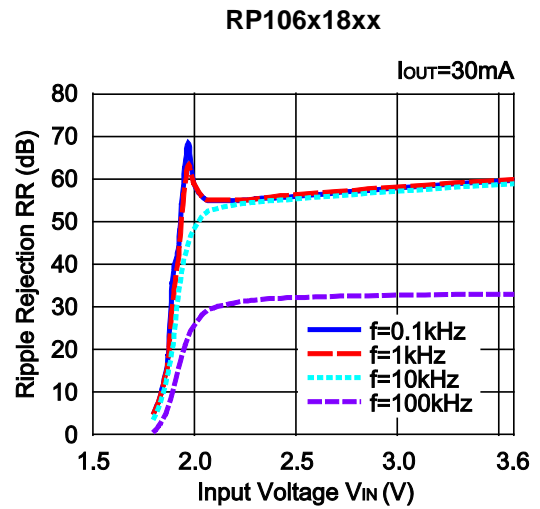
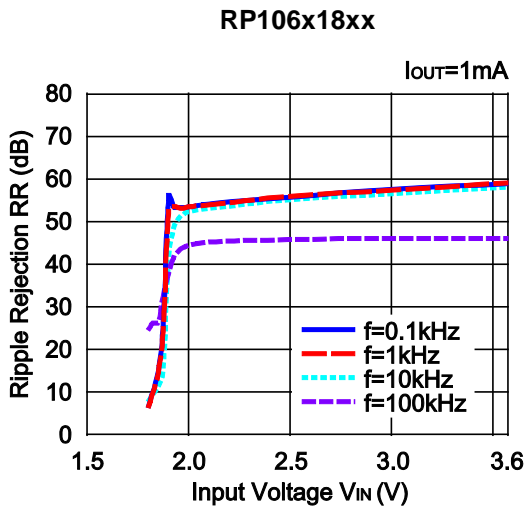

10) Ripple Rejection vs. Frequency ($C1=none$, $C2=1.0\mu F$, $Ripple=0.1Vp-p$, $T_{opt}=25^{\circ}C$)

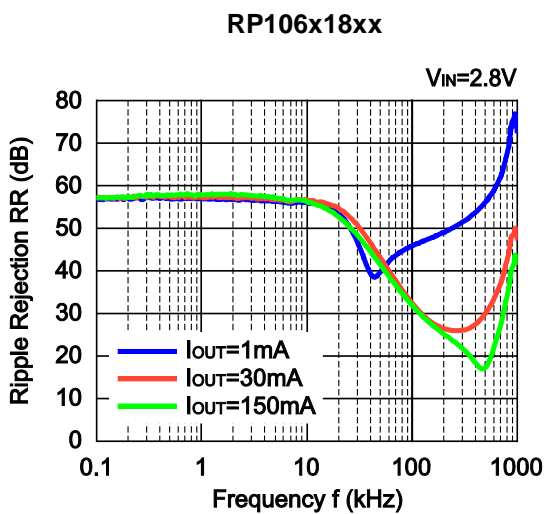
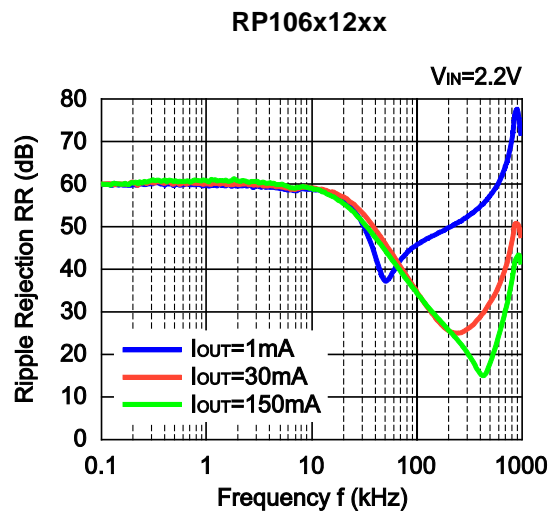
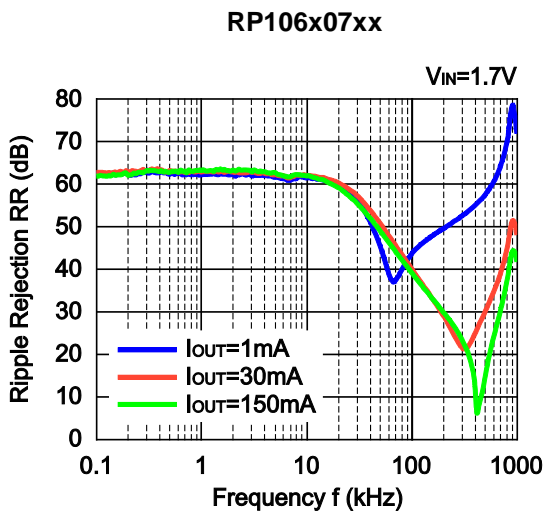

RP106x

NO.EA-180-200325

11) Input Transient Response (C1=none, C2=1.0μF, I_{OUT}=30mA, tr=tf=5μs, T_{opt}=25°C)

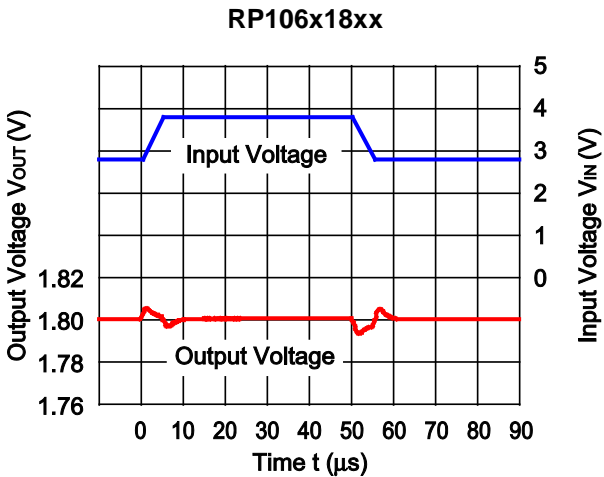
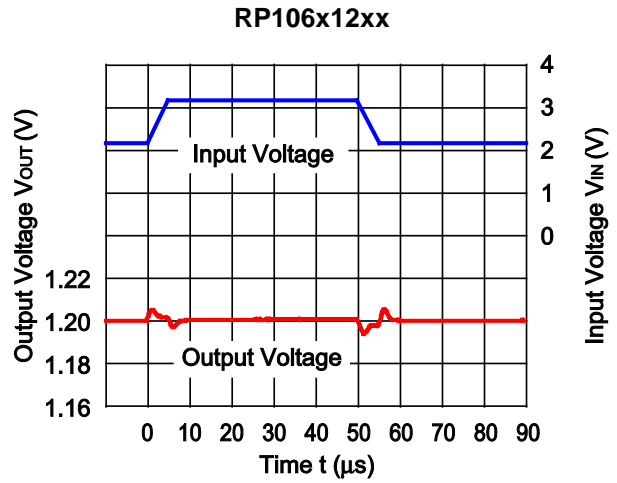
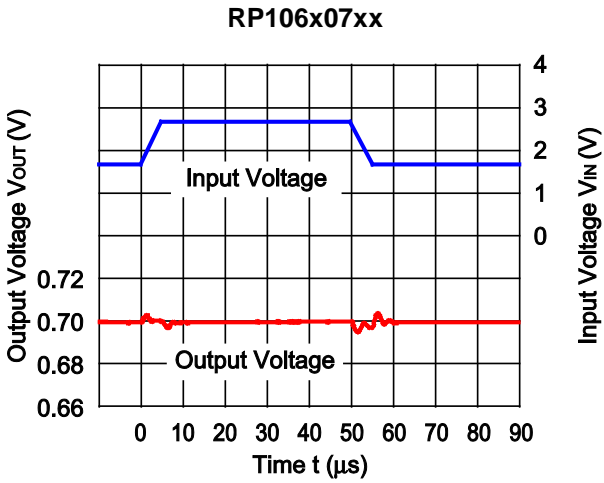

12) Load Transient Response (C1=C2=1.0μF, tr=tf=5μs, T_{opt}=25°C)

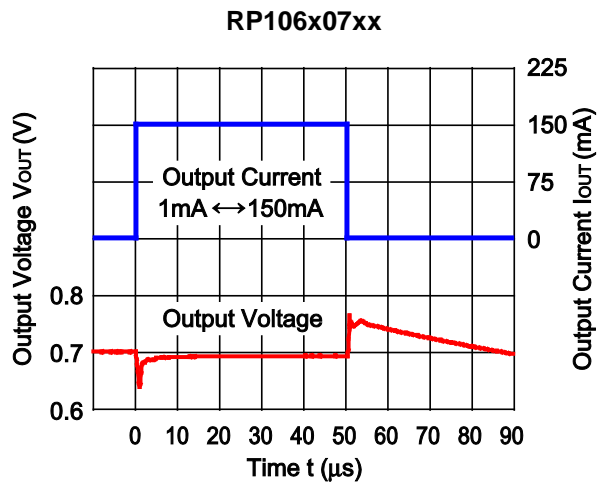
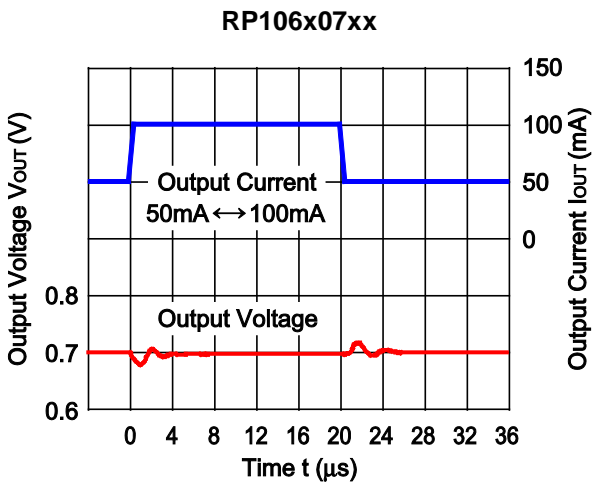

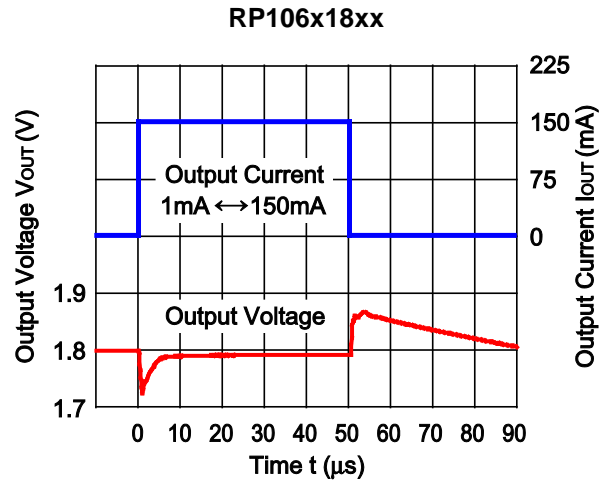
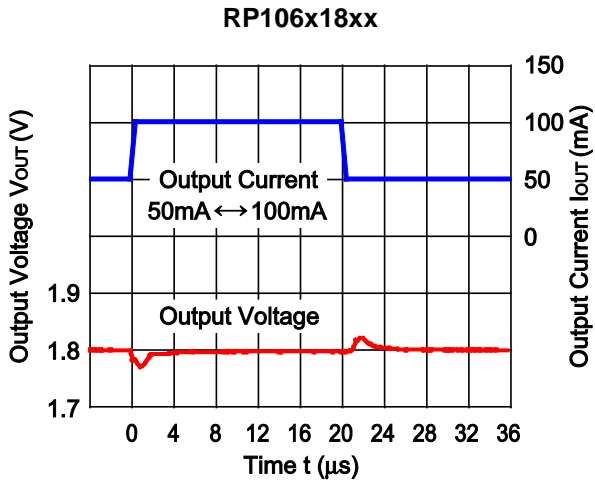
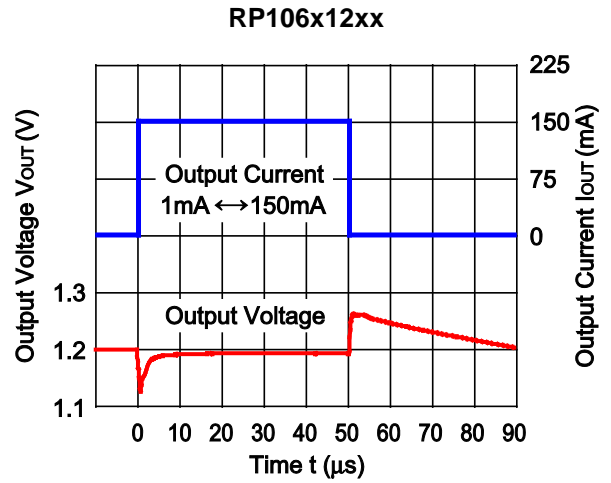
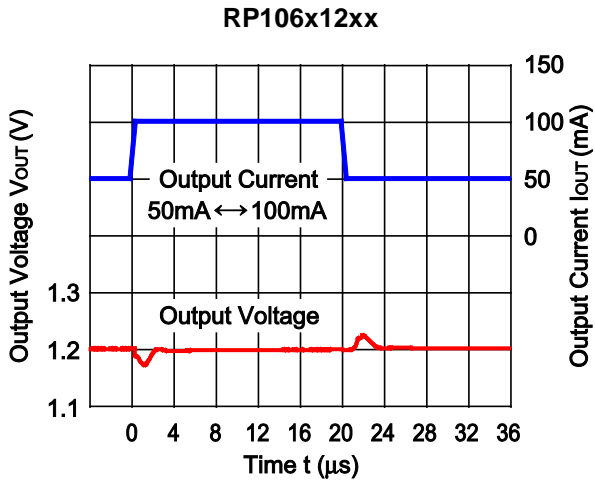

13) Turn On Speed with CE pin ($C1=C2=1.0\mu$ F, $T_{opt}=25^{\circ}$ C)

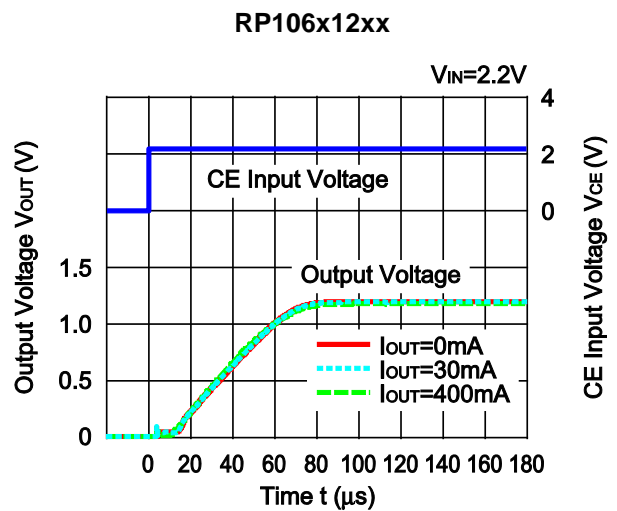
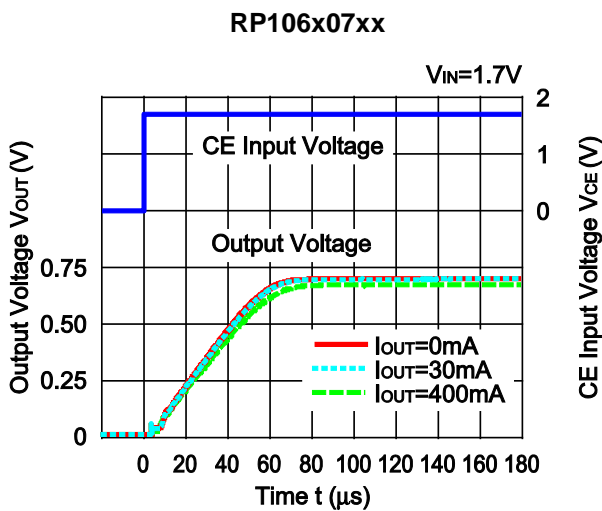

RP106x

NO.EA-180-200325

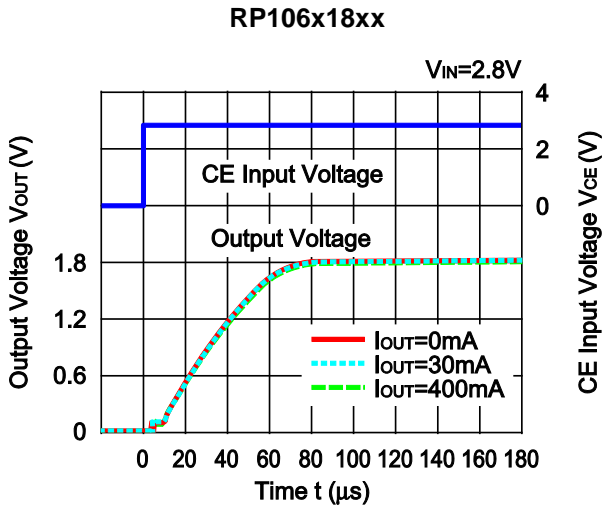

14) Turn Off Speed with CE pin ($C_1=C_2=1.0\mu F$, $T_{opt}=25^\circ C$)

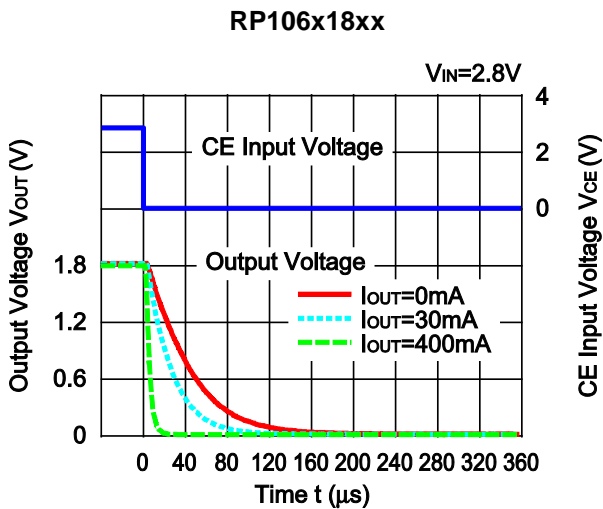
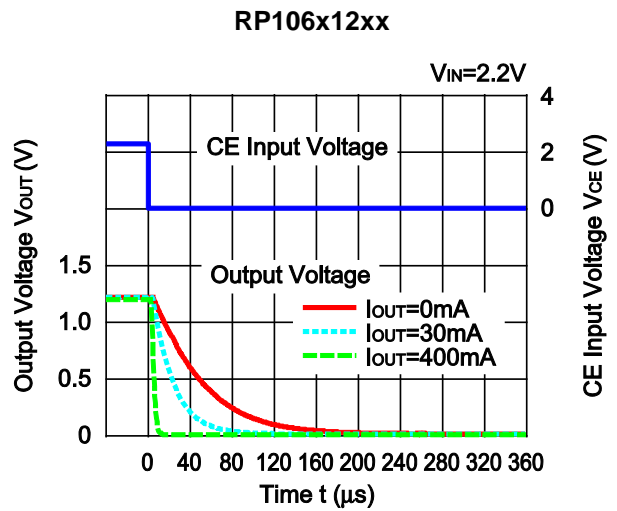
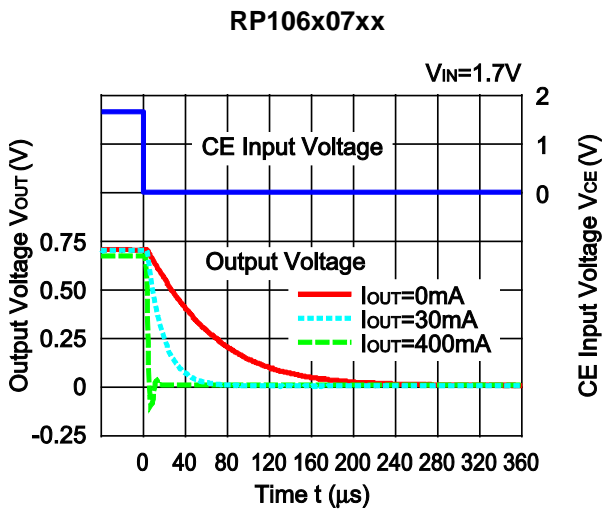

15) Inrush Current at Start up ($C_1=1.0\mu\text{F}$, $T_{\text{opt}}=25^\circ\text{C}$)

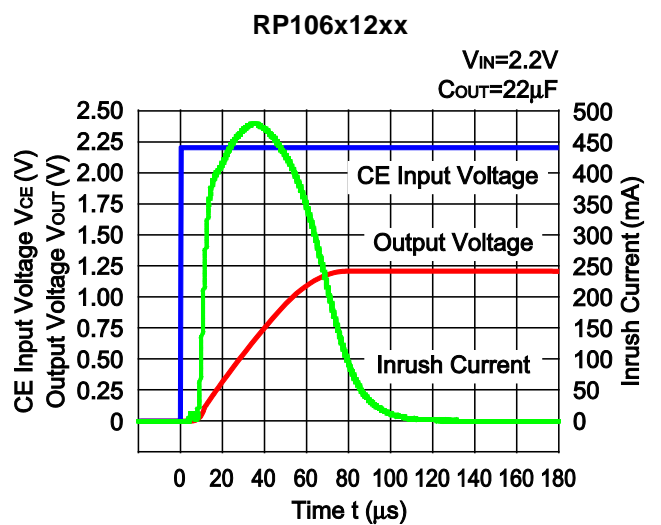
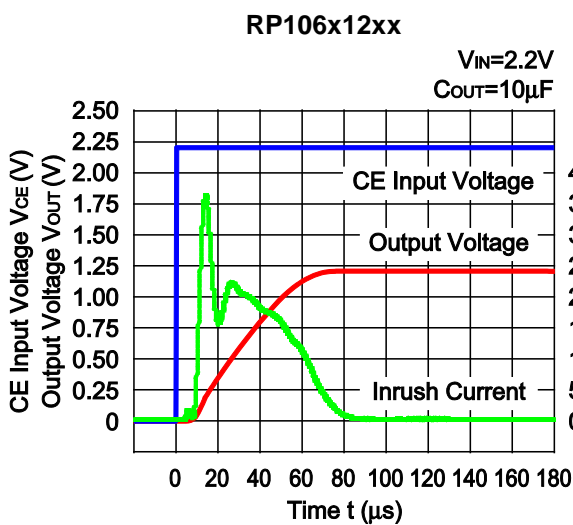
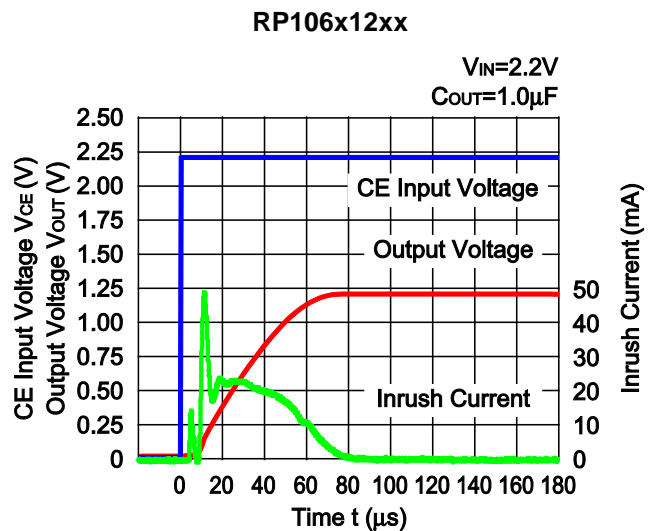
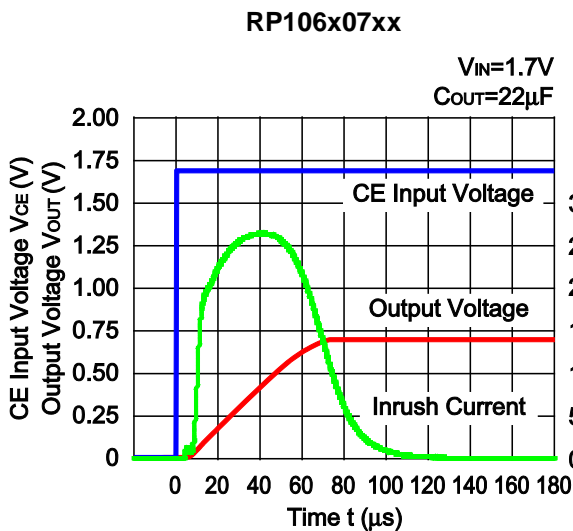
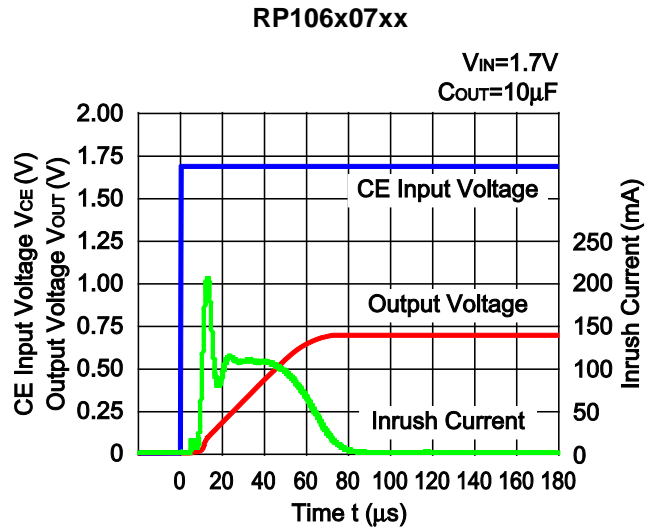
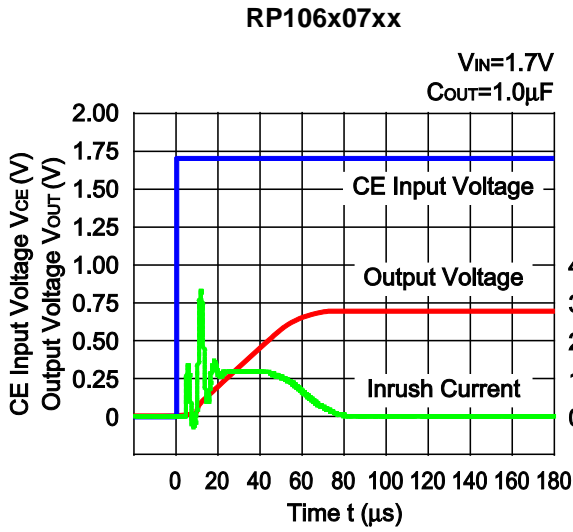

RP106x

NO.EA-180-200325

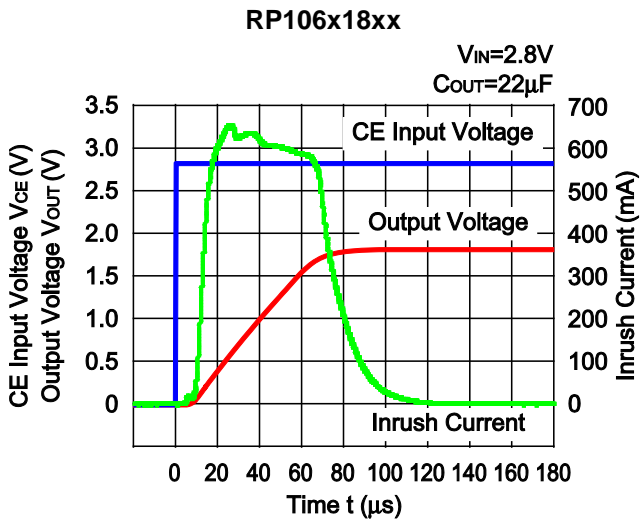
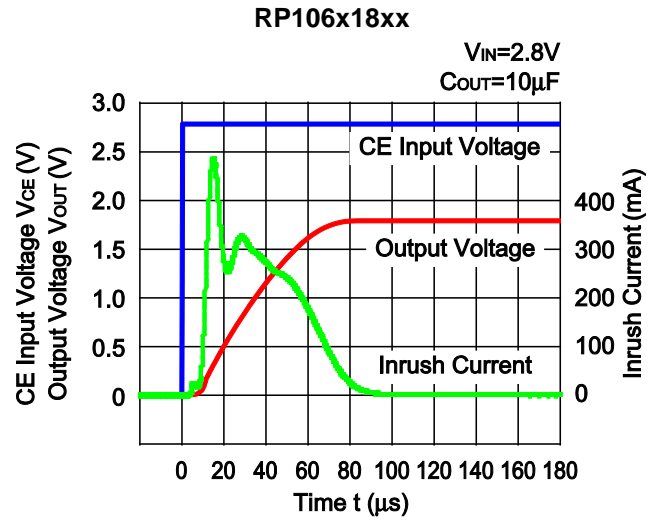
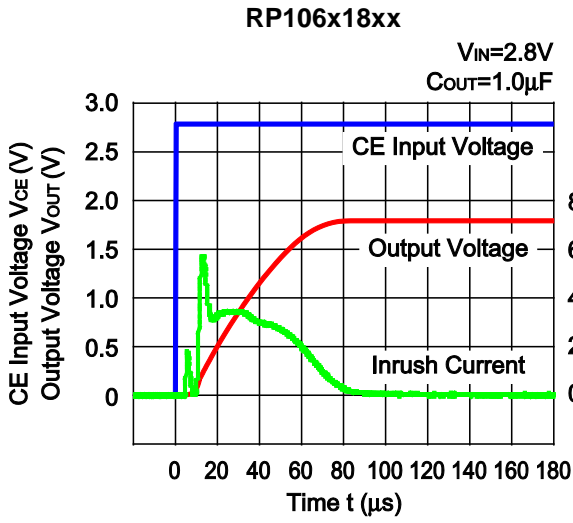

ESR vs. Output Current

When using these ICs, consider the following points:

The relations between I_{OUT} (Output Current) and ESR of an output capacitor are shown below.

The conditions when the white noise level is under $40\mu V$ (Avg.) are marked as the hatched area in the graph.

Measurement conditions

Frequency Band: 10Hz to 3MHz

Temperature : $-40^{\circ}C$ to $85^{\circ}C$

C1, C2 : $1.0\mu F$ MURATA GRM155B31A105KE15

If other than ceramic capacitors such as tantalum, the ESR of the capacitor might be higher than expected. This graph shows the stable area with ESR limit. In the actual evaluation, we used Murata GRM155B31A105KE15, therefore, bias characteristics of the same kind of ceramic capacitors are considered.

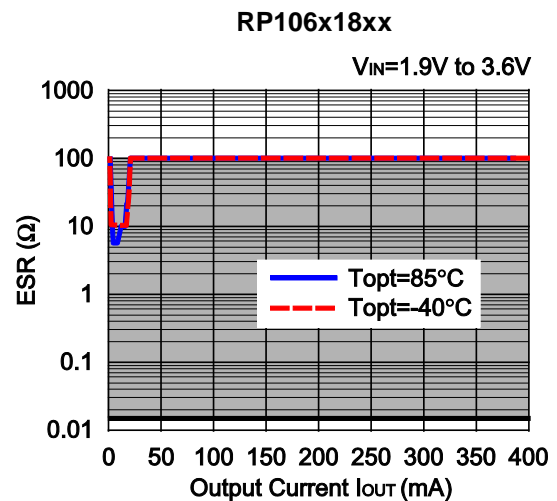
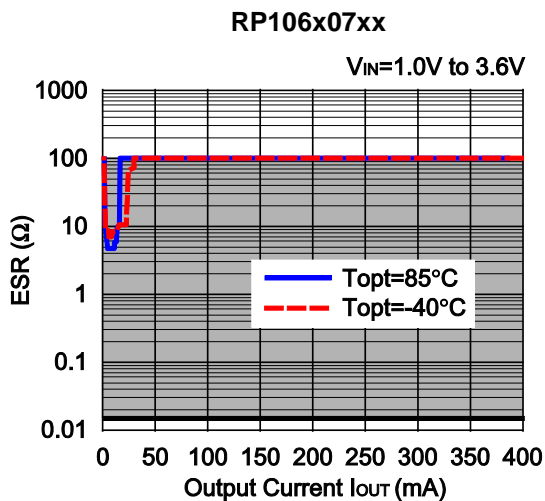



1. The products and the product specifications described in this document are subject to change or discontinuation of production without notice for reasons such as improvement. Therefore, before deciding to use the products, please refer to Ricoh sales representatives for the latest information thereon.
2. The materials in this document may not be copied or otherwise reproduced in whole or in part without prior written consent of Ricoh.
3. Please be sure to take any necessary formalities under relevant laws or regulations before exporting or otherwise taking out of your country the products or the technical information described herein.
4. The technical information described in this document shows typical characteristics of and example application circuits for the products. The release of such information is not to be construed as a warranty of or a grant of license under Ricoh's or any third party's intellectual property rights or any other rights.
5. The products listed in this document are intended and designed for use as general electronic components in standard applications (office equipment, telecommunication equipment, measuring instruments, consumer electronic products, amusement equipment etc.). Those customers intending to use a product in an application requiring extreme quality and reliability, for example, in a highly specific application where the failure or misoperation of the product could result in human injury or death (aircraft, spacevehicle, nuclear reactor control system, traffic control system, automotive and transportation equipment, combustion equipment, safety devices, life support system etc.) should first contact us.
6. We are making our continuous effort to improve the quality and reliability of our products, but semiconductor products are likely to fail with certain probability. In order to prevent any injury to persons or damages to property resulting from such failure, customers should be careful enough to incorporate safety measures in their design, such as redundancy feature, fire containment feature and fail-safe feature. We do not assume any liability or responsibility for any loss or damage arising from misuse or inappropriate use of the products.
7. Anti-radiation design is not implemented in the products described in this document.
8. The X-ray exposure can influence functions and characteristics of the products. Confirm the product functions and characteristics in the evaluation stage.
9. WLCSP products should be used in light shielded environments. The light exposure can influence functions and characteristics of the products under operation or storage.
10. There can be variation in the marking when different AOI (Automated Optical Inspection) equipment is used. In the case of recognizing the marking characteristic with AOI, please contact Ricoh sales or our distributor before attempting to use AOI.
11. Please contact Ricoh sales representatives should you have any questions or comments concerning the products or the technical information.



Ricoh is committed to reducing the environmental loading materials in electrical devices with a view to contributing to the protection of human health and the environment.

Ricoh has been providing RoHS compliant products since April 1, 2006 and Halogen-free products since April 1, 2012.

RICOH RICOH ELECTRONIC DEVICES CO., LTD.

Official website

<https://www.n-redc.co.jp/en/>

Contact us

<https://www.n-redc.co.jp/en/buy/>



Mouser Electronics

Authorized Distributor

Click to View Pricing, Inventory, Delivery & Lifecycle Information:

Ricoh Electronics:

[RP106K101D-TR](#) [RP106K121D-TR](#) [RP106Z121D5-TR-F](#) [RP106Z121D8-TR-F](#) [RP106K091D-TR](#) [RP106K101B-TR](#)
[RP106Z121D-TR-F](#) [RP106K181D-TR](#) [RP106K101D5-TR](#) [RP106K131D-TR](#) [RP106K071D5-TR](#) [RP106K071D-TR](#)
[RP106K081D-TR](#) [RP106K101B5-TR](#) [RP106Z111D-TR-F](#) [RP106Z121B-TR-F](#) [RP106Z131D-TR-F](#) [RP106Z151D-TR-](#)
[F](#) [RP106Z171D5-TR-F](#) [RP106Z181D-TR-F](#) [RP106Z071D-TR-F](#) [RP106Z101D-TR-F](#) [RP106Z111D5-TR-F](#)
[RP106K211B-TR](#) [RP106K271B-TR](#) [RP106K111D-TR](#) [RP106K121B5-TR](#) [RP106K121B-TR](#) [RP106K151D-TR](#)
[RP106K171D5-TR](#) [RP106K181B-TR](#) [RP106K131B-TR](#)