

## Features

- Low profile - typical height 1.1 mm
- Low forward voltage drop
- Low leakage current
- Moisture sensitivity: level 1, per J-STD-020
- High temperature soldering guaranteed: 260°C/10 seconds
- Halogen-free according to IEC 61249-2-21 definition

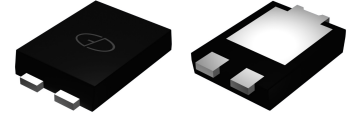

Package:  
eSGC (TO-277)

## Applications

For low voltage high frequency inverters, DC/DC converters and polarity protection applications.

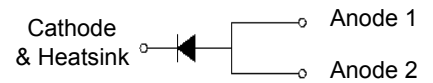

Schematic Diagram

## Maximum Ratings (T<sub>A</sub> = 25°C unless otherwise noted)

Parameter	Symbol	Value	Unit
Maximum Repetitive Peak Reverse Voltage	V <sub>RRM</sub>	60	V
Maximum RMS Voltage	V <sub>RMS</sub>	42	V
Maximum DC Blocking Voltage	V <sub>DC</sub>	60	V
Maximum Average Forward Rectified Current	I <sub>F(AV)</sub>	10	A
Peak Forward Surge Current (8.3ms single half sine-wave superimposed on rated load)	I <sub>FSM</sub>	280	A
Operating Junction and Storage Temperature Range	T <sub>J</sub> , T <sub>STG</sub>	-55 to +150	°C

## Electrical Characteristics (T<sub>A</sub> = 25°C unless otherwise noted)

Parameter	Test Conditions		Symbol	Typ.	Max.	Unit
Maximum Instantaneous Forward Voltage	I <sub>F</sub> =1A	T <sub>A</sub> =25°C	V <sub>F</sub>	0.30	0.35	V
	I <sub>F</sub> =2A			0.33	0.38	
	I <sub>F</sub> =10A			0.45	0.5	
	I <sub>F</sub> =1A	T <sub>A</sub> =85°C		0.22	0.27	
	I <sub>F</sub> =2A			0.25	0.3	
	I <sub>F</sub> =10A			0.44	0.48	
	I <sub>F</sub> =1A	T <sub>A</sub> =125°C		0.16	0.20	
	I <sub>F</sub> =2A			0.20	0.24	
	I <sub>F</sub> =10A			0.43	0.46	
Maximum DC Reverse Current at Rated DC Blocking Voltage	Rated V <sub>R</sub>	T <sub>A</sub> =25°C	I <sub>R</sub>	0.18	0.3	mA
		T <sub>A</sub> =85°C		14	18	
		T <sub>A</sub> =100°C		35	39	
Junction Capacitance	4.0 V, 1 MHz		C <sub>J</sub>	950		pF
Typical Thermal Resistance	Juntion to Lead		R <sub>θJL</sub>	60		°C/W

## Ratings and Characteristics Curves ( $T_A = 25^\circ\text{C}$ unless otherwise noted)

Forward Current Derating Curve

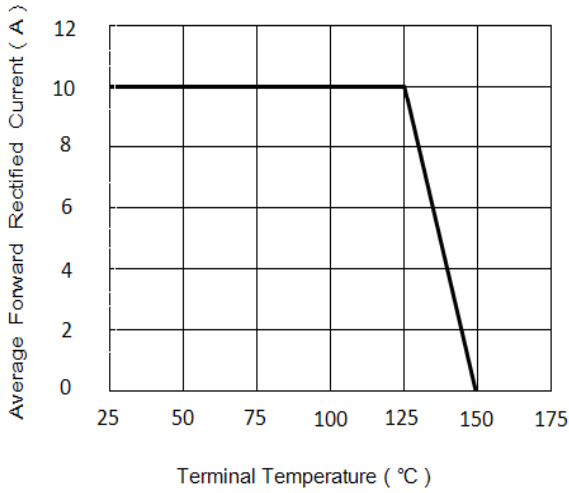

Typical Instantaneous Forward Characteristics

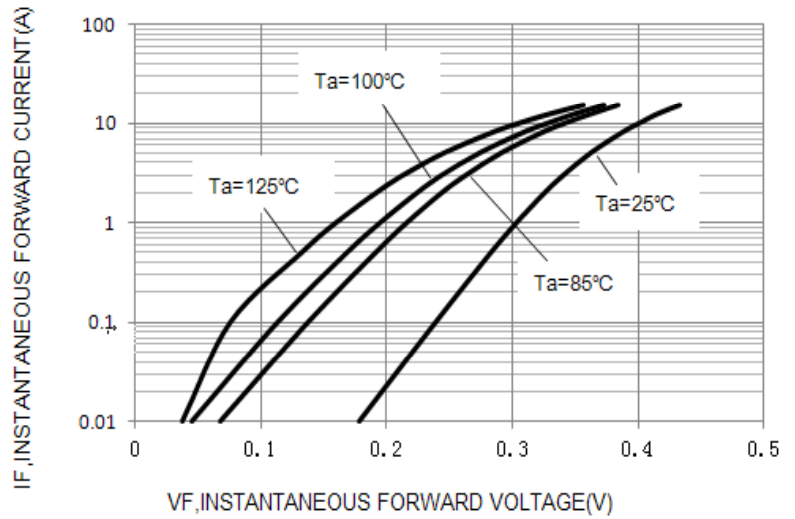

TYPICAL JUNCTION CAPACITANCE

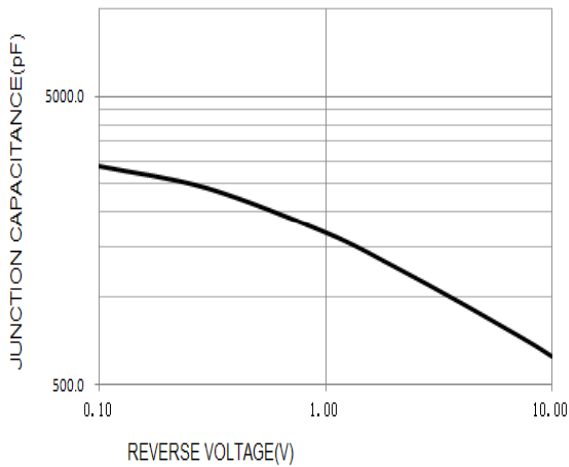

Typical Reverse Characteristics

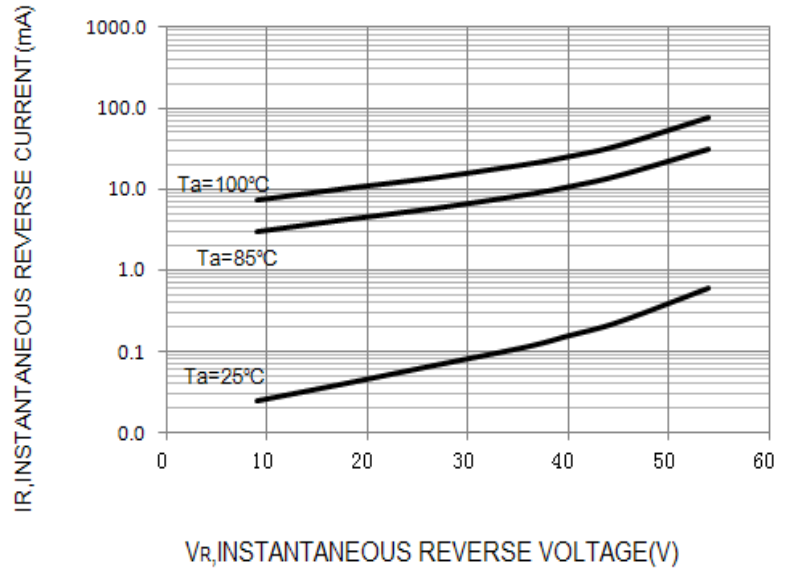

MAXIMUM NON-REPETITIVE SURGE CURRENT

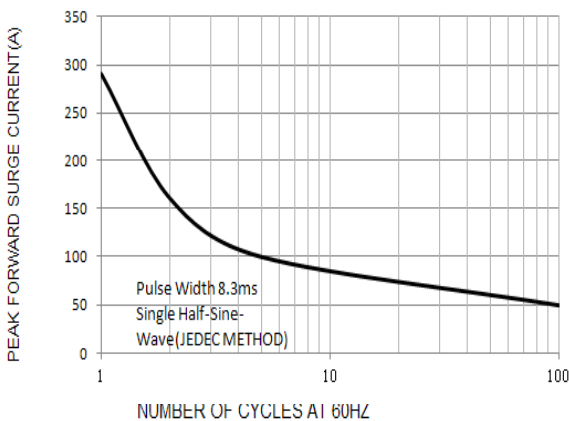

## Package Outline Dimensions

eSGC (TO-277)

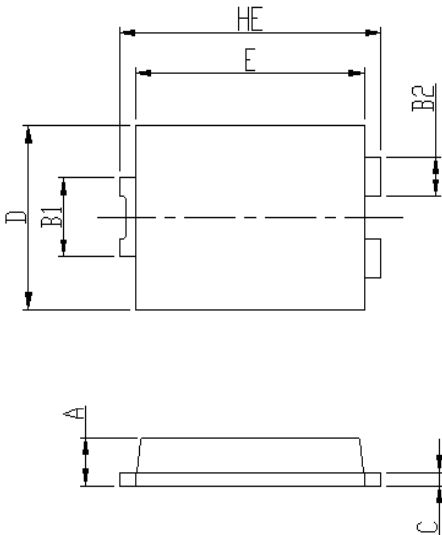

DIM	Unit: mm		Unit: inch	
	MIN	MAX	MIN	MAX
HE	6.4	6.6	0.252	0.260
E	5.6	5.8	0.220	0.228
D	4.1	4.3	0.161	0.169
B1	1.7	1.9	0.067	0.075
B2	0.8	1	0.031	0.039
A	1.05	1.2	0.041	0.047
C	0.3	0.4	0.012	0.016
L	0.85	1.1	0.033	0.043
L1	4.2	4.4	0.165	0.173
L2	3.52 Typ.		0.139 Typ.	
L3	1.1	1.4	0.043	0.055
D1	3	3.3	0.118	0.130
E1	1.86 Typ.		0.073 Typ.	

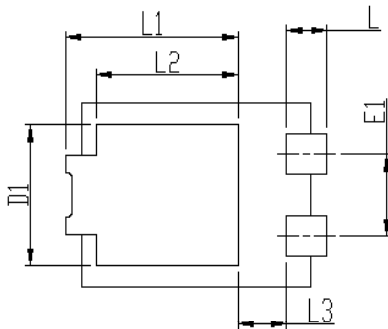

Soldering footprint

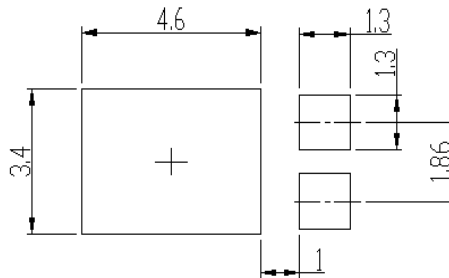

## Packing Information

### Packing quantities

5000 pcs/Reel, 12 mm Tape, 13" Reel

### Tape & Reel Specification

