

Features

- Low profile - typical height 1.1 mm
- Low forward voltage drop
- Low leakage current
- Moisture sensitivity: level 1, per J-STD-020
- High temperature soldering guaranteed: 260°C/10 seconds
- Halogen-free according to IEC 61249-2-21 definition

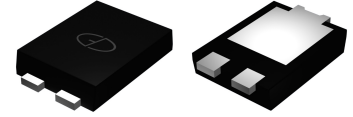

Package:
eSGC (TO-277)

Applications

For low voltage high frequency inverters, DC/DC converters and polarity protection applications.

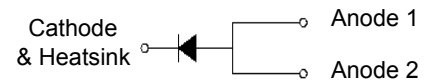

Schematic Diagram

Maximum Ratings (T_A = 25°C unless otherwise noted)

Parameter	Symbol	Value	Unit
Maximum Repetitive Peak Reverse Voltage	V _{RRM}	50	V
Maximum RMS Voltage	V _{RMS}	35	V
Maximum DC Blocking Voltage	V _{DC}	50	V
Maximum Average Forward Rectified Current	I _{F(AV)}	8.0	A
Peak Forward Surge Current (8.3ms single half sine-wave superimposed on rated load)	I _{FSM}	200	A
Operating Junction and Storage Temperature Range	T _J , T _{STG}	-55 to +150	°C

Electrical Characteristics (T_A = 25°C unless otherwise noted)

Parameter	Test Conditions		Symbol	Typ	Max	Unit
	I _F	T _A				
Instantaneous Forward Voltage	I _F =8A	T _A =25°C	V _F	-	0.48	V
	I _F =8A	T _A =125°C		0.42	-	
Maximum DC Reverse Current at Rated DC Blocking Voltage	Rated V _R	T _A =25°C	I _R	-	0.50	mA
		T _A =125°C		-	50	
Typical Junction Capacitance	4.0 V, 1 MHz		C _J	565		pF
Typical Thermal Resistance	Juntion to lead		R _{θJL}	10		°C/W

Note1) Thermal resistance R_{θJL} is junction to lead, mounted on P.C.B with 30*30mm copper pad area

Ratings and Characteristics Curves ($T_A = 25^\circ\text{C}$ unless otherwise noted)

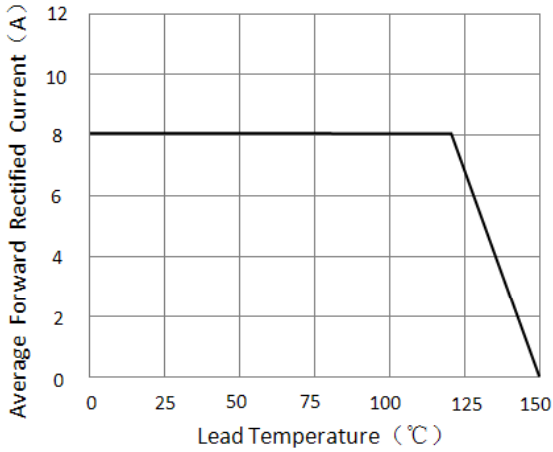

Figure 1. Forward Current Derating Curve

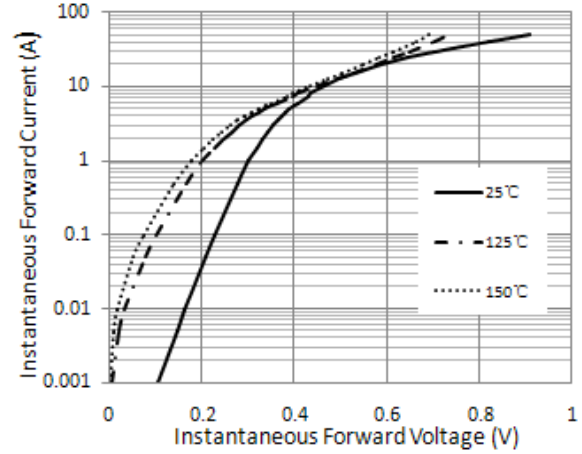

Figure 2. Typical Instantaneous Forward Characteristics

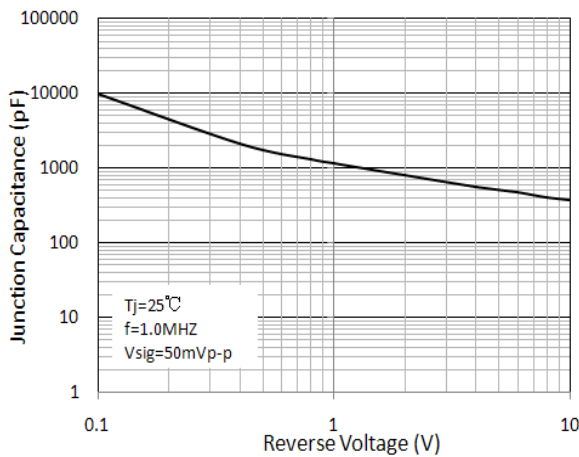

Figure 3. Typical Junction Capacitance

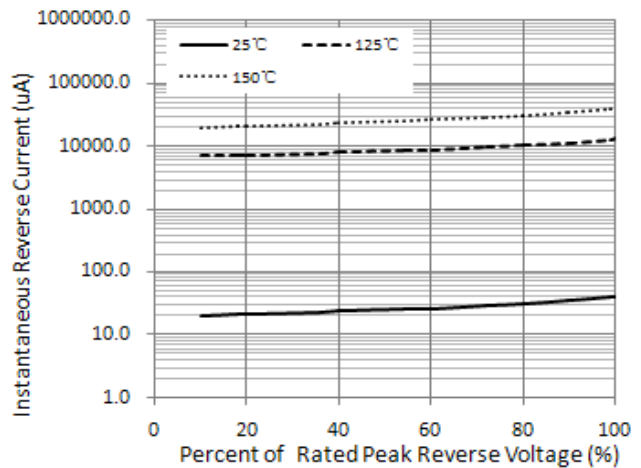

Figure 4. Typical Reverse Characteristics

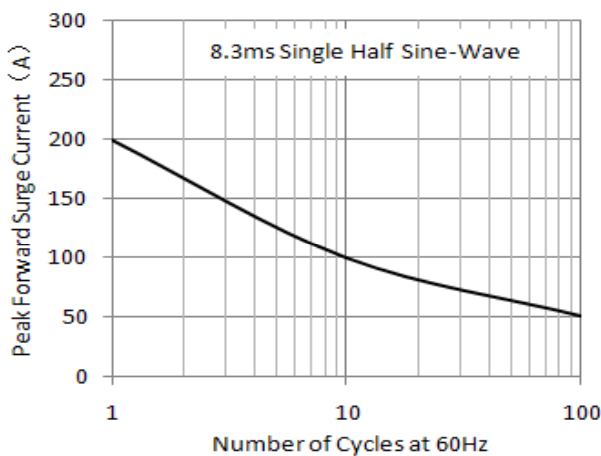
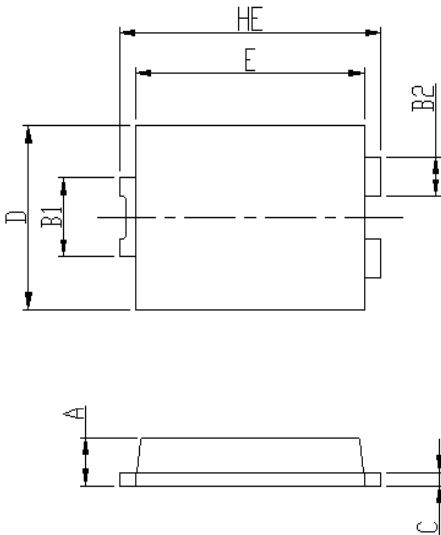

Figure 5. Maximum Non-Repetitive Peak Forward Surge Current

Package Outline Dimensions

eSGC (TO-277)



DIM	Unit: mm		Unit: inch	
	MIN	MAX	MIN	MAX
HE	6.4	6.6	0.252	0.260
E	5.6	5.8	0.220	0.228
D	4.1	4.3	0.161	0.169
B1	1.7	1.9	0.067	0.075
B2	0.8	1	0.031	0.039
A	1.05	1.2	0.041	0.047
C	0.3	0.4	0.012	0.016
L	0.85	1.1	0.033	0.043
L1	4.2	4.4	0.165	0.173
L2	3.52 Typ.		0.139 Typ.	
L3	1.1	1.4	0.043	0.055
D1	3	3.3	0.118	0.130
E1	1.86 Typ.		0.073 Typ.	

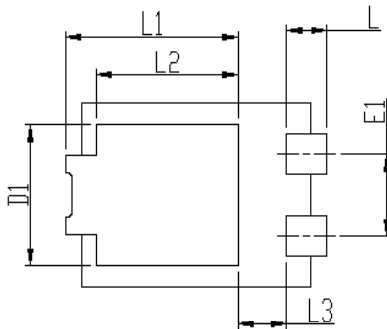

Soldering footprint

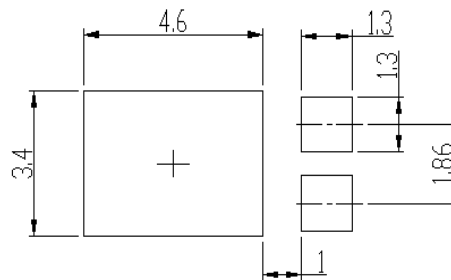

Packing Information

Packing quantities

5000 pcs/Reel, 12 mm Tape, 13" Reel

Tape & Reel Specification

