

# Standard Product Reference Sheet

FHY1105P-TR

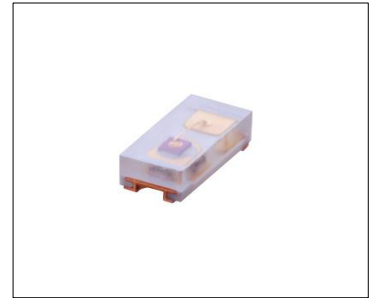

## Features

Package	1005(t=0.25mm) Type, water clear lens Outer Dimension 1.0 x 0.5 x 0.25mm ( L x W x H )
Product features	<ul style="list-style-type: none"><li>•Lead-free soldering compatible</li><li>•RoHS compliant</li></ul>

## Recommended Applications

- Communication Machine, Electric Household Appliances, OA/FA, Other General Applications

# Outline Dimensions

# FHY1105P-TR

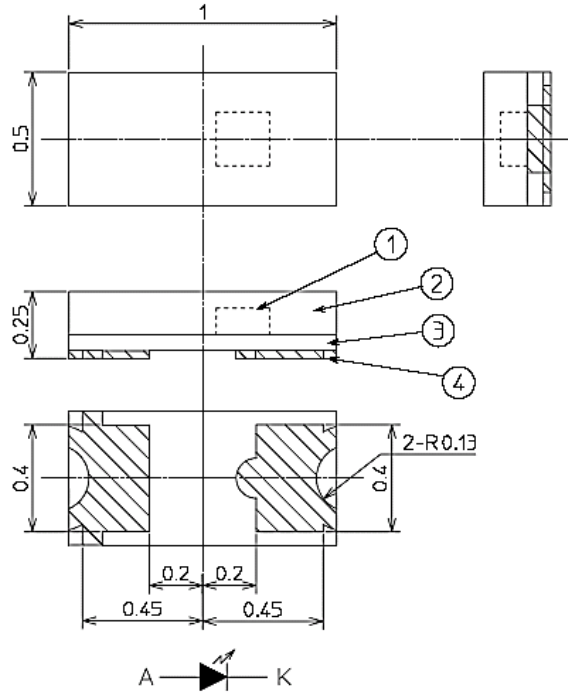

Unit :mm  
 Weight :0.29mg  
 Tolerance :±0.1

NO.	PART NAME	MATERIALS	QTY.
①	LED Die	AlGaInP	1
②	Mold resin	Epoxy Resin	1
③	PCB	Glass Fabrics	1
④	Electrode	Au/Ni/Cu	2

Note: Outline Dimensions do not include the size of cutting burr around substrate and pin(electrodes)

# Recommended Pad

Unit :mm  
 Tolerance :±0.1

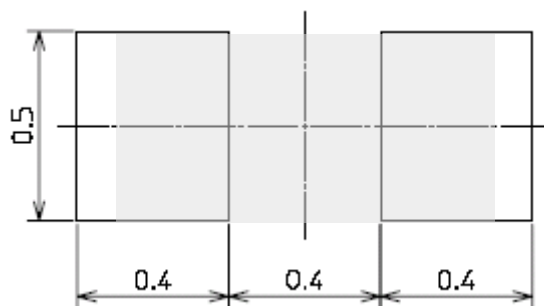

## 【 Product Overview 】

Die Material	AlGaInP
Emitting Color	Yellow
Resin Color(Emitting Area)	Water clear

## 【 Absolute Maximum Ratings 】

(Ta=25°C)

ITEM	SYMBOL	MAXIMUM RATINGS	UNITS
Power Dissipation	$P_d$	48	mW
Forward Current	$I_F$	20	mA
Repetitive Peak Forward Current "1ms,1/20duty"	$I_{FRM}$	48	mA
$I_F$ Derate Linearly from "25°C"	$\Delta I_F$	0.27	mA/°C
$I_{FRM}$ Derate Linearly from "25°C"	$\Delta I_{FRM}$	0.64	mA/°C
Reverse Voltage	$V_R$	5	V
Operating Temperature	$T_{opr}$	-40 ~ +85	°C
Storage Temperature	$T_{stg}$	-40 ~ +100	°C
Soldering Temperature "Reflow Soldering"	$T_{sld}$	260	°C

## 【 Electro and Optical Characteristics 】

(Ta=25°C)

ITEM	SYMBOL	CONDITIONS	MIN.	TYP.	MAX.	UNITS
Forward Voltage	$V_F$	$I_F = 5\text{mA}$	-	1.9	2.4	V
Reverse Current	$I_R$	$V_R = 5\text{V}$	-	-	100	$\mu\text{A}$
Luminous Intensity	$I_V$	$I_F = 5\text{mA}$	22.5	32.0	45.0	mcd
Peak Wavelength	$\lambda_p$	$I_F = 5\text{mA}$	-	594	-	nm
Dominant Wavelength	$\lambda_d$	$I_F = 5\text{mA}$	585	590	595	nm
Spectral Line Half Width	$\Delta\lambda$	$I_F = 5\text{mA}$	-	15	-	nm

Note:

Above Luminous Intensity ( $I_V$ ) values and Dominant wavelength ( $\lambda_d$ ) values are the setup value of the selection machine. 【Tolerance :  $I_V \dots \pm 10\%$ ,  $\lambda_d \dots \pm 1\text{nm}$ 】

## 【 Sorting For Luminous Intensity and Dominant Wavelength 】

LED's shall be sorted out into the following ranks of Luminous Intensity and Dominant Wavelength.

### Luminous Intensity ( $I_V$ ) Rank

Rank	IV (mcd)		Conditions
	MIN.	MAX.	
A	22.5	32.0	$I_F = 5\text{mA}$ $T_a = 25^\circ\text{C}$
B	32.0	45.0	

Note:

Above Luminous Intensity (IV) values are the setup value of the selection machine. 【Tolerance :  $I_V \dots \pm 10\%$ 】

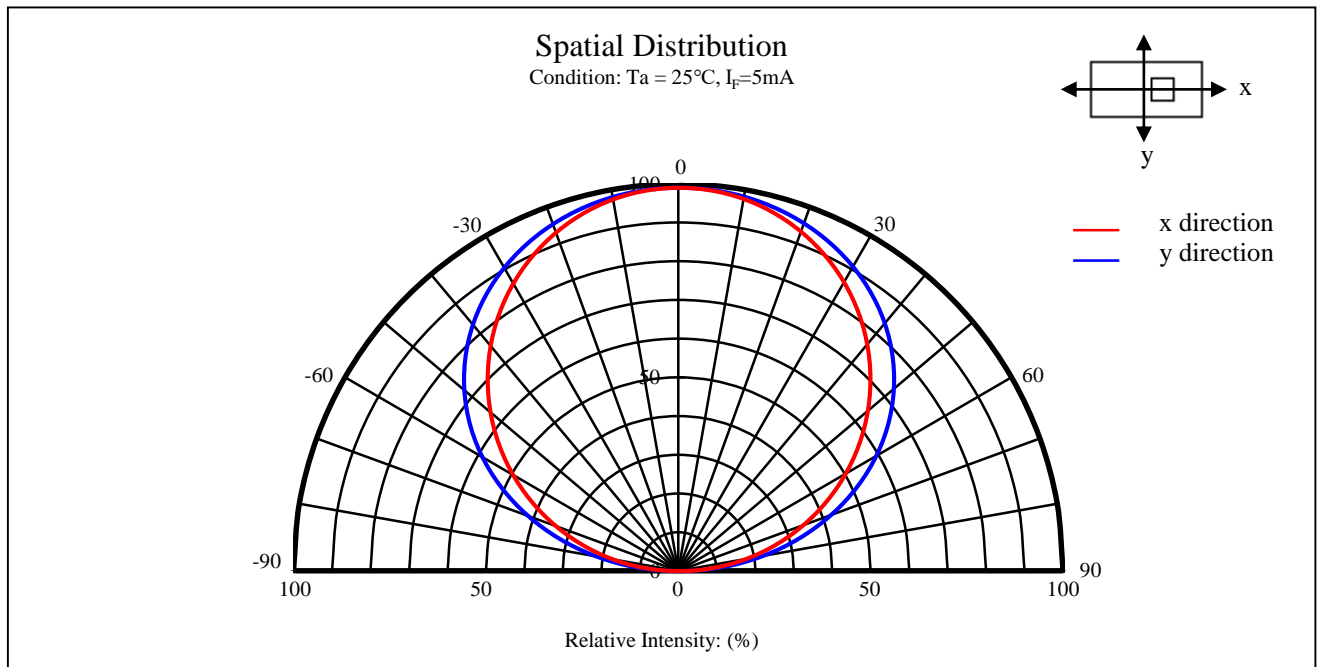
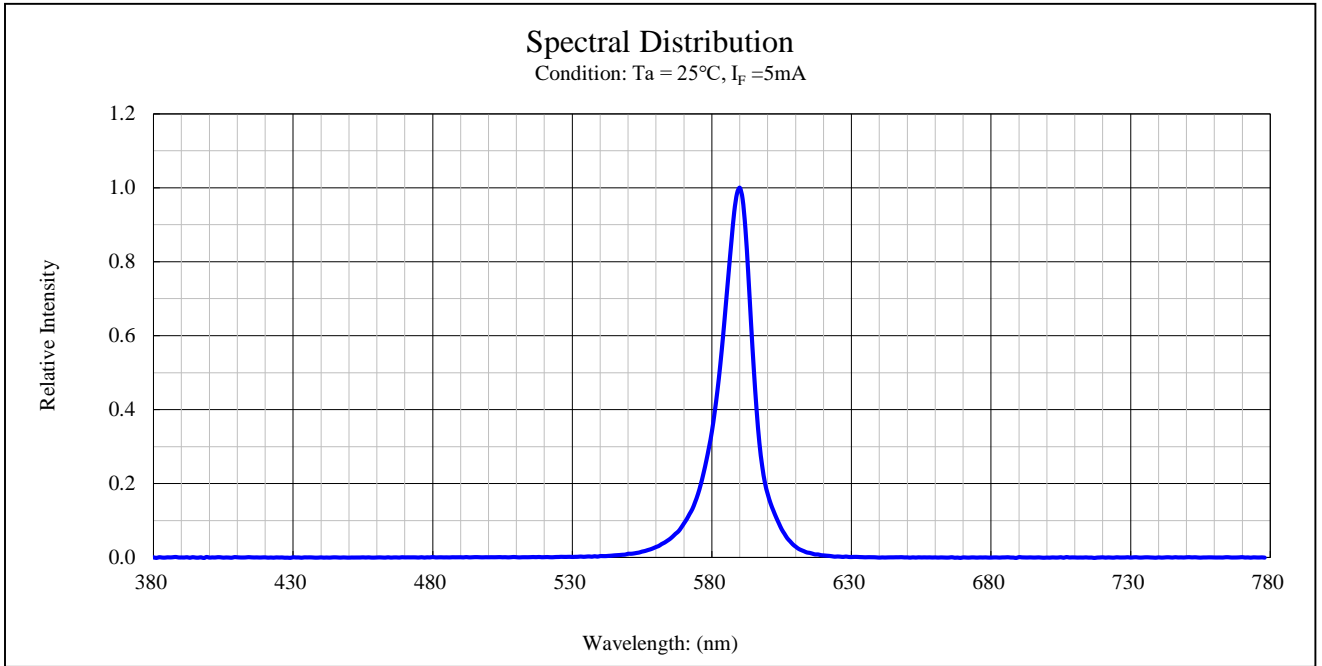

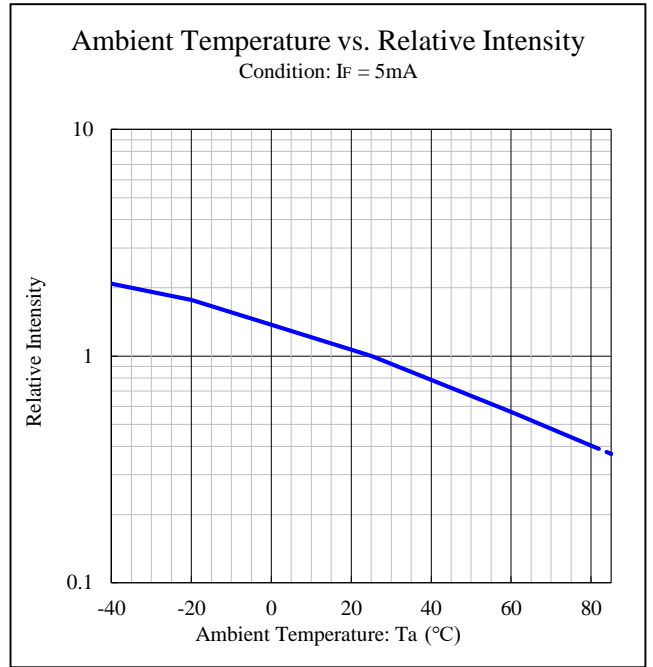
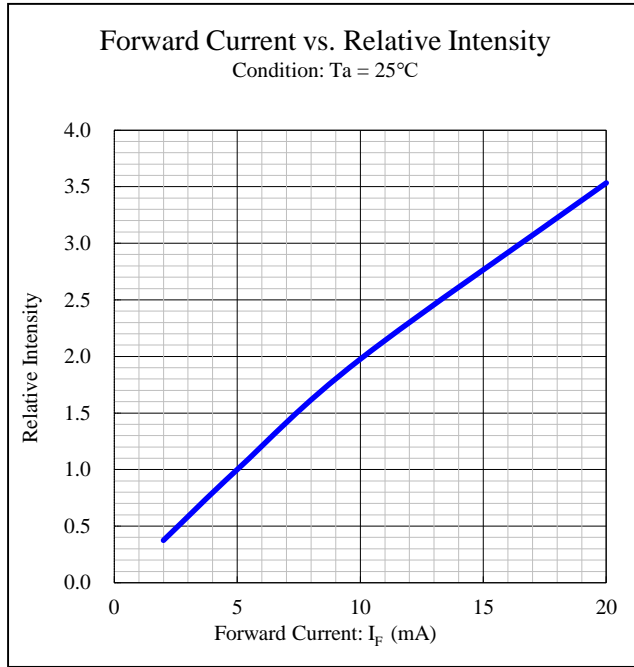
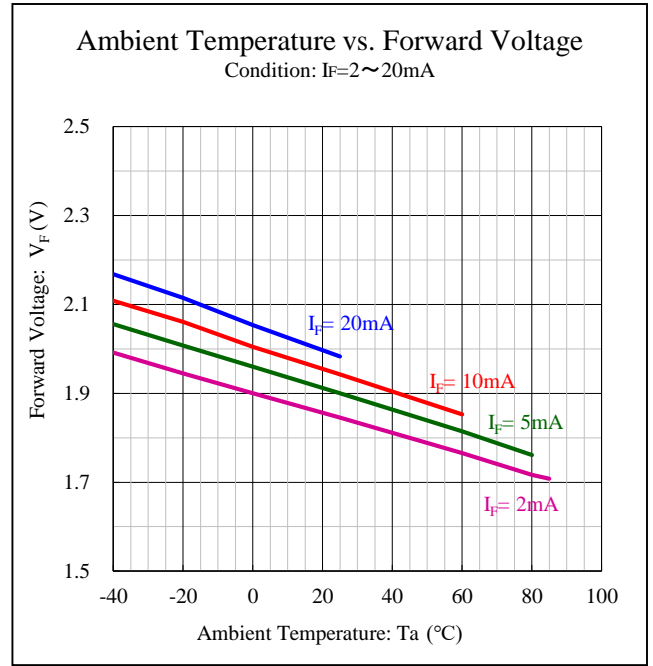
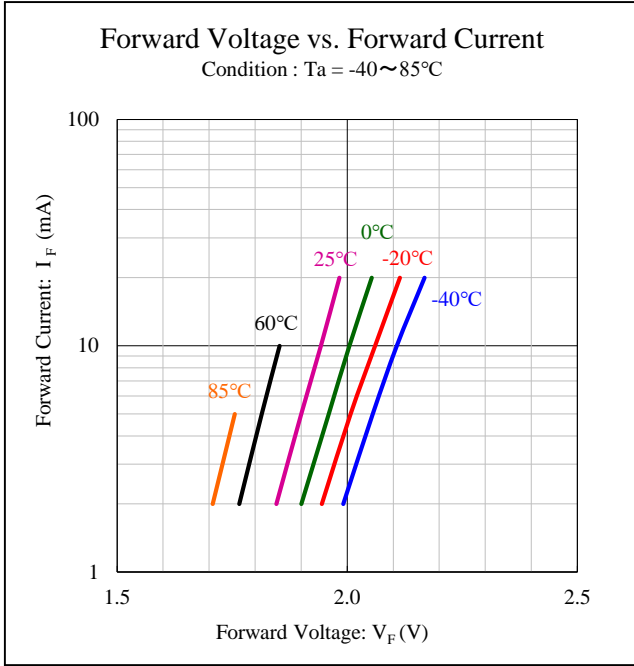

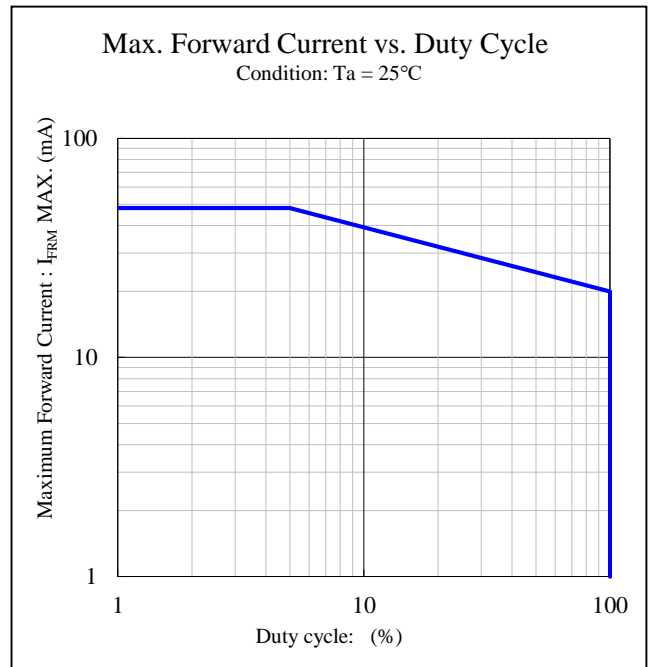
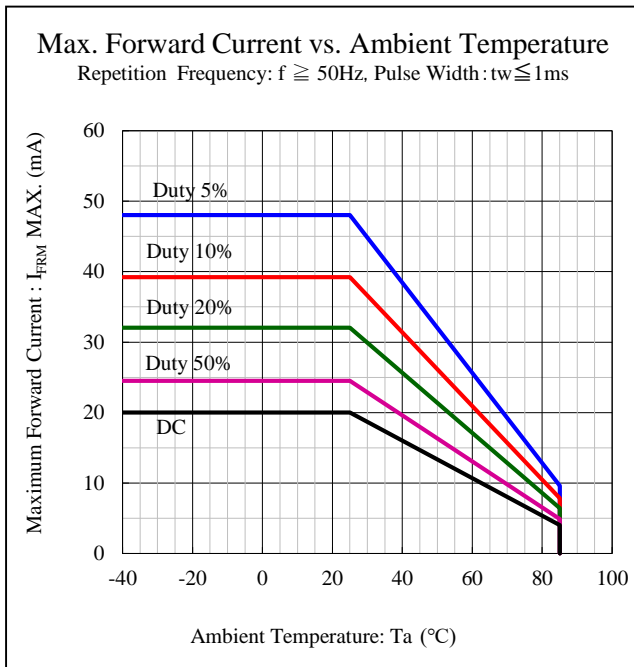
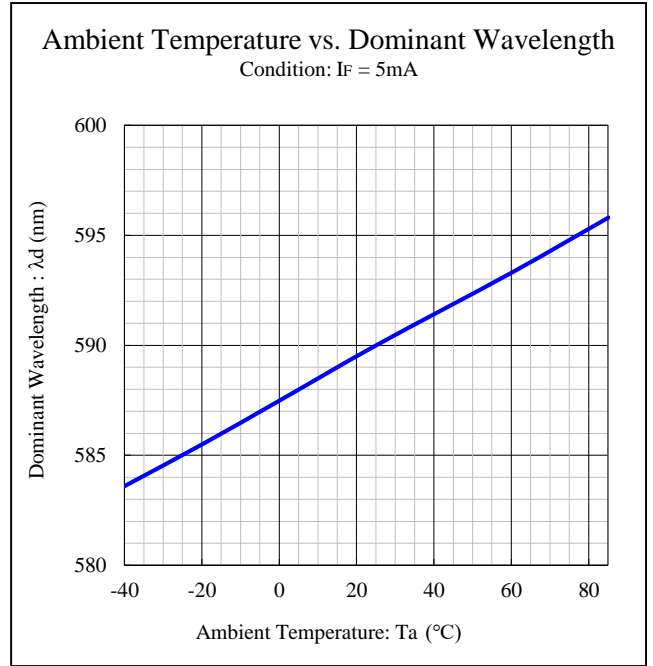
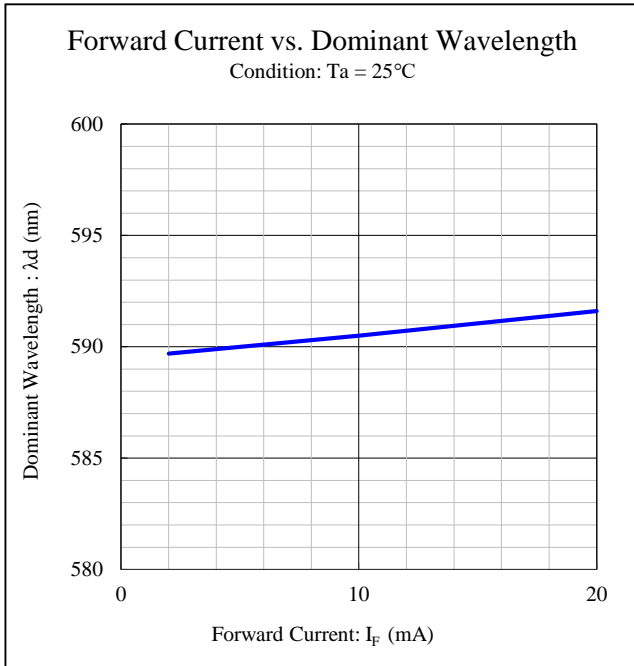

## 【Soldering Precautions】

(acc.to EIAJ-4701/300)

- Heat stress during soldering will greatly influence the reliability of LEDs, however that effect will vary depending on the heating method. Also, if components of varying shape are soldered together, it is recommended to set the soldering pad temperature according to the component most vulnerable to heat stress (ex. SMT LED). (Recommended Condition: Soldering Pad temp. > Package temp.)
- Because LED parts including the resin are not stable immediately after soldering (when they are not at room temperature), any mechanical stress may cause damage to the product. Please avoid such stress after soldering, especially stacking of the boards, which may cause the boards to warp, and any other types of friction with hard materials).
- Recommended temperature profile for the Reflow soldering is listed as the temperature of the resin surface. Temperature distribution varies on heating method, PCB material, other components in the assembly, and mounting density .  
Please do not repeat the heating process during Reflow process more than twice.

## 【Recommended reflow soldering condition】

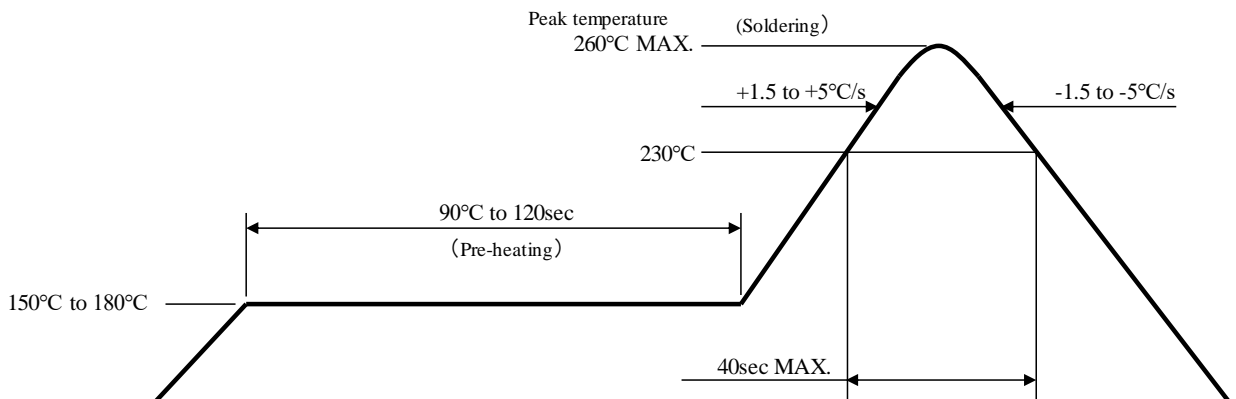

Note 1 Temperature Profile for the reflow soldering is listed as the temperature of resin surface. This represents the maximum temperature ratings for soldering. Lowering the heating temperature and decreasing heating time is very effective in ensuring higher reliability.

Note 2 The reflow soldering process should be done up to twice (2 times Max). When the second process is performed, the interval between first and second process should be as short as possible to prevent absorption of moisture by LED resin. The second soldering process should not be done until LEDs have returned to room temperature (by natural cooling) after the first soldering process.



# Soldering conditions

**FHY1105P-TR**

4. When using adhesive material for tentative fixatives, thermosetting resin or ultraviolet radiation (UV) setting resin with heat shall be recommended.  
 《Curing conditions: Temperature:150°CMax./Time:120sec.Max.》
5. The products cannot be used for hand soldering and dipping (through the wave) soldering.
6. Isopropyl alcohol is recommended for cleaning. Some chemicals, including Freon substitute detergents, could corrode the lens or the casing surface, which cause discoloration, clouds, crack and so on. Please review the reference chart below for cleaning. If water is used to clean (including the final cleaning process), please use pure water (not tap water), and completely dry the component before using.

Cleaning agents	Recommended / Not recommended
Isopropyl alcohol	✓ <b>Recommended</b>
Ethyl alcohol	✓ <b>Recommended</b>
Pure water	✓ <b>Recommended</b>
Trichloroethylene	x <b>Not recommended</b>
Chlorothene	x <b>Not recommended</b>
Acetone	x <b>Not recommended</b>
Thinner	x <b>Not recommended</b>

## 【 Other Precautions 】

1. Stanley LED Lamps have semiconductor characteristics and are designed to ensure high reliability. However, the performance may vary depending on usage conditions.
2. Absolute maximum ratings are set to prevent LED devices from failing due to excess stress (temperature, current, voltage, etc.). Usage conditions must not exceed the ratings for a moment, nor do reach one item of absolute maximum ratings simultaneously.
3. In order to ensure high reliability from LED devices, variable factors that arise in actual usage conditions should be taken into account for designing (derating of typ., max. forward voltage, etc.).
4. Please insert straight protective resistors into the circuit in order to stabilize LED operations and to prevent the device from igniting due to excess current.
5. Please avoid using the products with materials and products that contain sulfur and chlorine elements, which will decrease the reliability of the LEDs. Please keep the LEDs in a desiccator to protect them from corrosive gas, regardless of whether mounting is finished or not. Also, please make sure there is no gas around or flowing from outside when using the LEDs.
6. Please check the actual performance in the assembly because the specification sheets are described for LED devices only.
7. Please refrain from looking directly at the light source of the LEDs at high output, as it may harm your vision.
8. The products are designed to operate without failure in recommended usage conditions. However, please take the necessary precautions to prevent fire, injury, and other damages should any malfunction or failure arise.
9. The products are manufactured to be used for ordinary electronic equipment. Please contact our sales staff beforehand when exceptional quality and reliability are required, and the failure or malfunction of the products might directly jeopardize life or health (such as for airplanes, aerospace, transport equipment, medical applications, nuclear reactor control systems and so on).
10. The formal specification sheets shall be valid only by exchange of documents signed by both parties.

This product is baked (moisture removal) before packaging, and is shipped in a moisture-proof packaging (as shown below) to minimize moisture absorption during transportation and storage. However, with regard to storing the products, Stanley recommends the use of a dry box under the following conditions. A moisture-proof bag is used as the packaging is made of anti-static material but packaging box is not.

## 【Recommended storage conditions / Products warranty period】

Temperature	+5~30°C
Humidity	Under 70%

In the case of an unopened package, **under 6 months** 【Recommended storage conditions】. Please avoid rapid transition from low temp. conditions to high temp. conditions and storage in corroding and dusty environment.

## 【Time elapsed after package opening】

The package should not be opened until immediately prior to its use, and please keep the time frame between package opening and soldering at **【maximum 72h.】**  
If the device needs to be soldered 2times, both soldering must be completed within the 72h.

If any component should remain after their use, please seal the package and store them under the conditions described in the 【Recommended Storage Conditions】.

This product must be required to perform baking process (moisture removal) **for at least 23h, not exceed for 48h, at 60±5 degrees Celsius** if following conditions apply.

1. In case of silica gel, which indicates the moisture level within the package, changing or losing its blue color.
2. If more than 72h have passed after the package is opened once.

Baking process should be performed after the LEDs have been taken out of the package.

Baking may be performed in the tape-reel form, however if it is performed with the reels stacked over one another, it may cause deformation of the reels and taping materials, and later obstruct mounting. Please handle only once it has returned to room temperature. Provided that, baking process shall be 2 times MAX.

**【Moisture-proof packaging specification】**

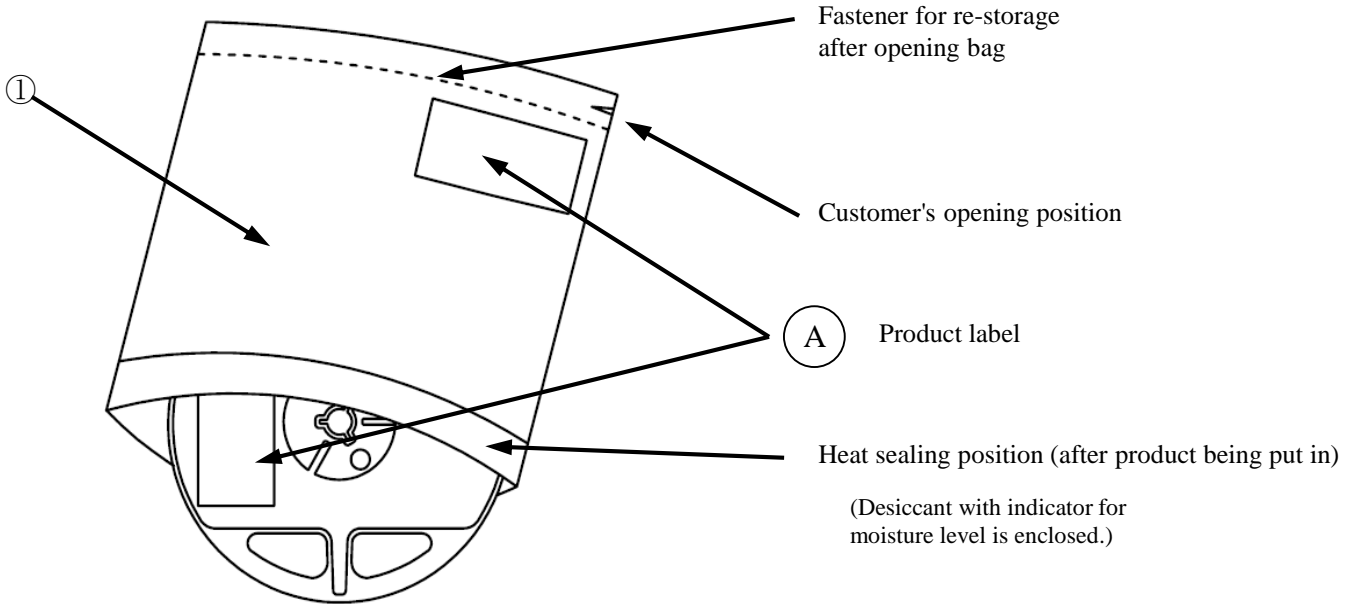

NO.	PART NAME	MATELRIALS	REMARKS
①	Moisture-proof bag with Aluminum layer	PET+Al+PE	with ESD protection

**【Flow Chart-package Opening to Mounting】**

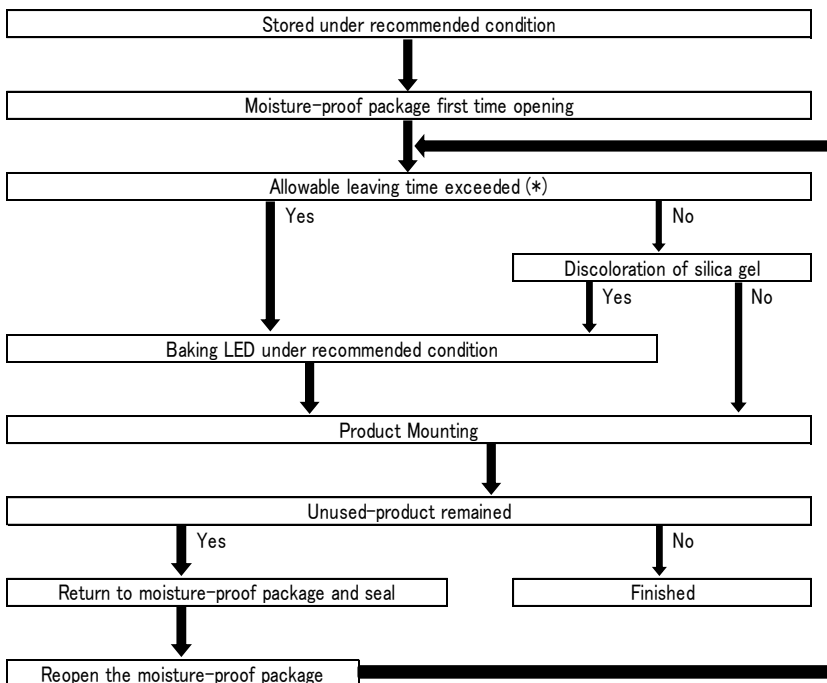

Allowable leaving time means the maximum allowable leaving time after opening package, which depends on each LED type. The allowable leaving time should be calculated from the first opening of package to the time when soldering process is finished. When judging if the allowable leaving time has exceeded or not, please subtract the soldering time after reopening. The allowable leaving time after reopening should be calculated from the first opening of package, or from the time when baking process is finished.

# Packaging specifications

FHY1105P-TR

## 【 Packing box 】

(RoHS2/ELV compliant)

Box type	Outline dimension L × W × H (mm)	Capacity of the box
Type A	280 × 265 × 45	3 reels
Type B	310 × 235 × 265	15 reels
Type C	440 × 310 × 265	30 reels
Type D	305 × 270 × 65	3 reels
Type E	370 × 280 × 270	30 reels
Type F	530 × 380 × 270	60 reels

The above measurements are reference values.

The box is selected out of the above table by shipping quantity.

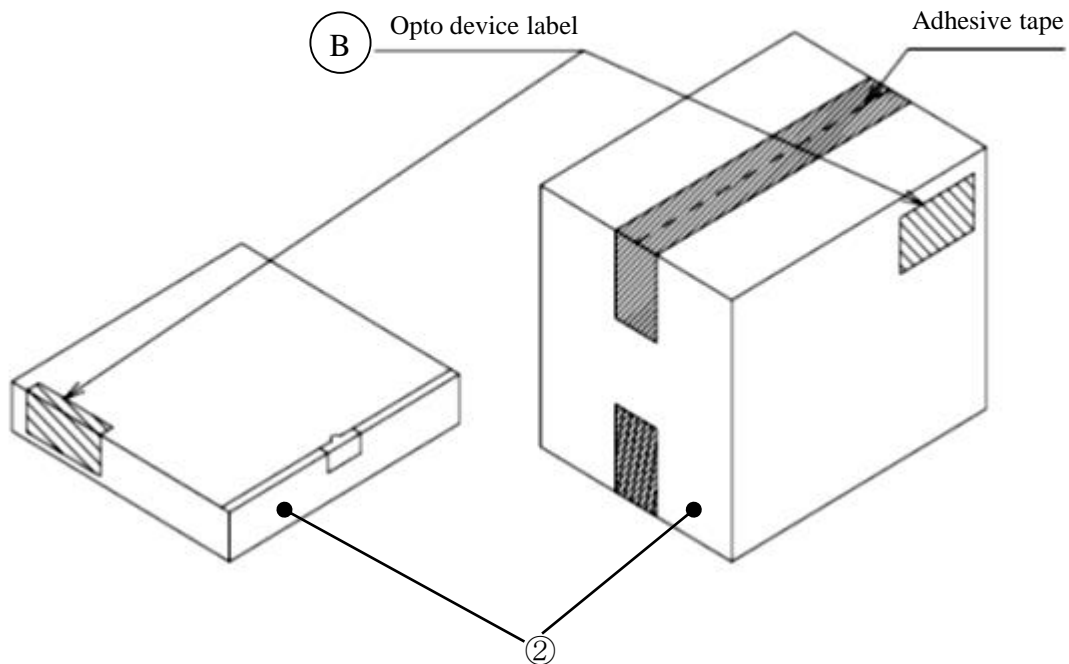

Type A

Material / box : Cardboard C5BF

Type B, C

Material / box : Cardboard K5AF  
Partition : Cardboard K5BF

Type D

Material / box : Cardboard C5WF

Type E, F

Material / box : Cardboard BC-KA125/3CA125/KA125

No.	Part name	Material	Remarks
②	Packing box	Corrugated Cardboard	without ESD protection

**【Label Specification】**

( acc.to JIS-X0503(Code-39) )

**A** Product label

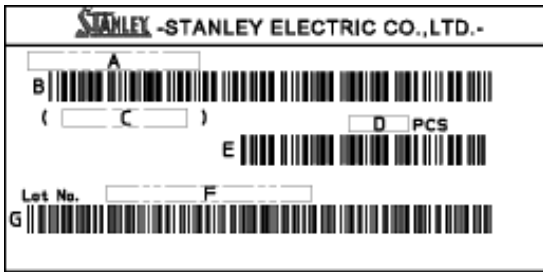

- A. Parts number
- B. Bar-code for parts number
- C. Parts code (In-house identification code for each parts number)
- D. Packed parts quantity
- E. Bar-Code for packed parts quantity
- F. Lot number & Rank  
(refer to Lot Number Notational System for details )
- G. Bar-Code for Lot number & Rank

**B** Opto device label

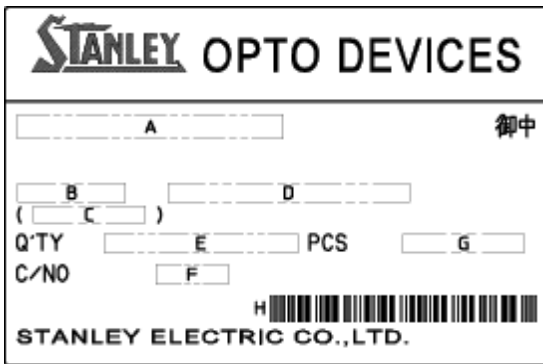

- A. Customer Name
- B. Parts Type
- C. Parts Code
- D. Parts Number
- E. Packed Parts Quantity
- F. Carton Number
- G. Shipping Date
- H. Bar-Code for In-house identification Number

<Remark> Bar-code font : acc.to Code-39(JIX0503)

# Taping and Reel Specifications

FHY1105P-TR

(acc.to JIS-C0806-03)

## 【Appearance】

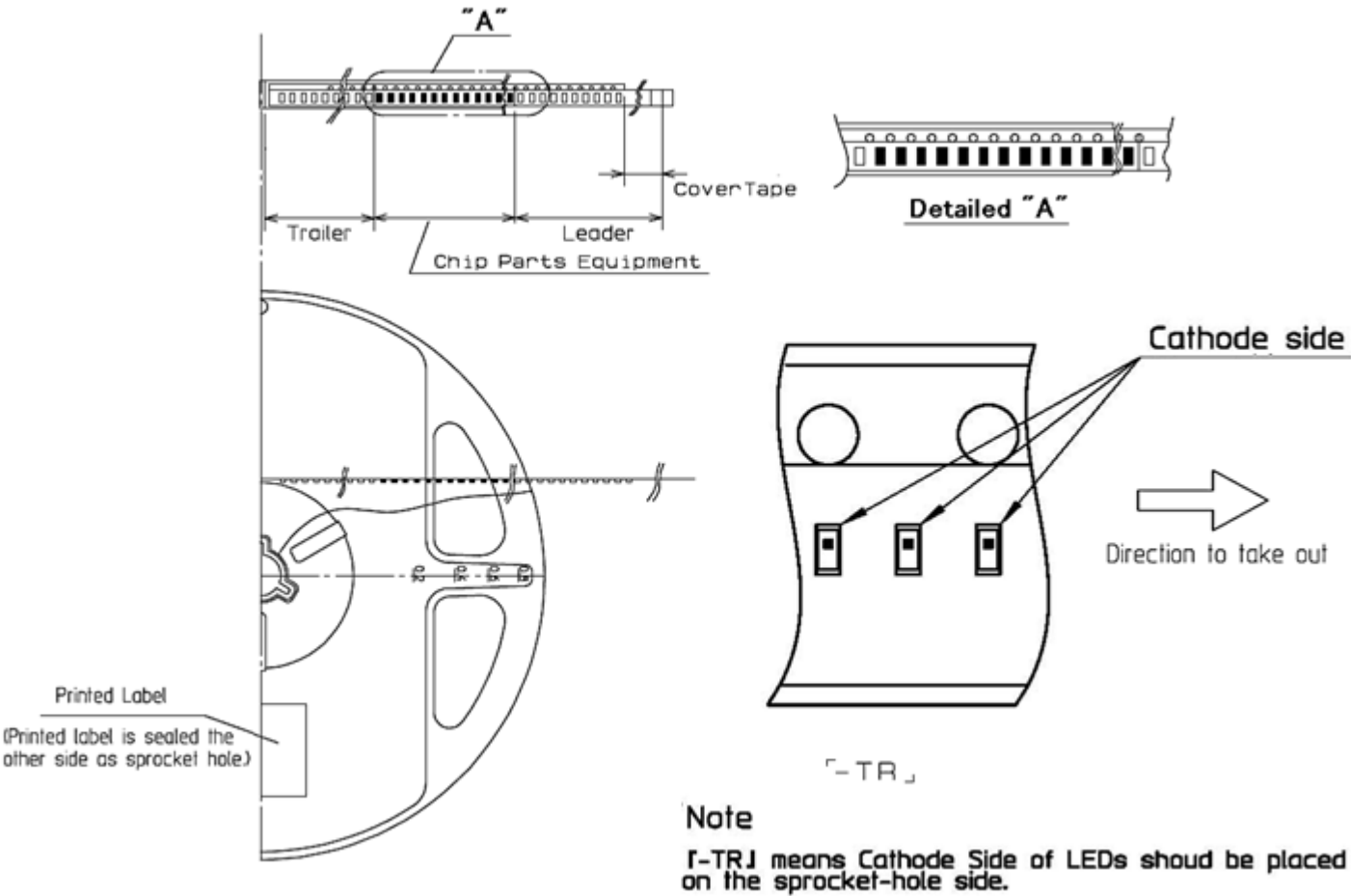

Items		Specifications	Remarks
Leader area	Cover-tape	Cover-tape shall be longer than 320mm without carrier-tape	The end of cover-tape shall be held with adhesive tape.
	Carrier-tape	Empty pocket shall be more than 20 pieces.	Please refer to the above figure for Taping & reel orientation .
Trailer area		Empty pocket shall be more than 15 pieces.	The end of taping shall be inserted into a slit of the hub.

# Taping and Reel Specifications

**FHY1105P-TR**

(acc.to JIS-C0806-03)

**【Qty. per Reel】**

10,000parts/reel

Minimum Qty. per reel might be 500 parts when getting less than 10,000 parts. In such case, parts of 500-unit-qty shall be packed in a reel and the qty. shall be identified on the label

**【Mechanical strength】**

Cover-tape adhesive strength shall be 0.1~1.0N (an angle between carrier-tape and cover-tape shall be 170 deg.) Both tapes shall be sealed so that the contained parts will not come out from the tape when it is bent at a radius of 15mm.

**【Others】**

Reversed-orientation, upside-down placing, side placing and out of spec parts mix shall not be held. Max qty of empty pocket per reel shall be defined as follows.

Qty./reel	Max. qty. of empty pocket	Remarks
to 1,000	1	-
to 2,000	2	No continuance
to 3,000	3	No continuance
to 4,000	4	No continuance
to 5,000	5	No continuance
to 6,000	6	No continuance
to 7,000	7	No continuance
to 8,000	8	No continuance
to 9,000	9	No continuance
to 10,000	10	No continuance



# Taping and Reel Specifications

FHY1105P-TR

(acc.to JIS-C0806-03)

Unit :mm

## 【Taping Dimensions】

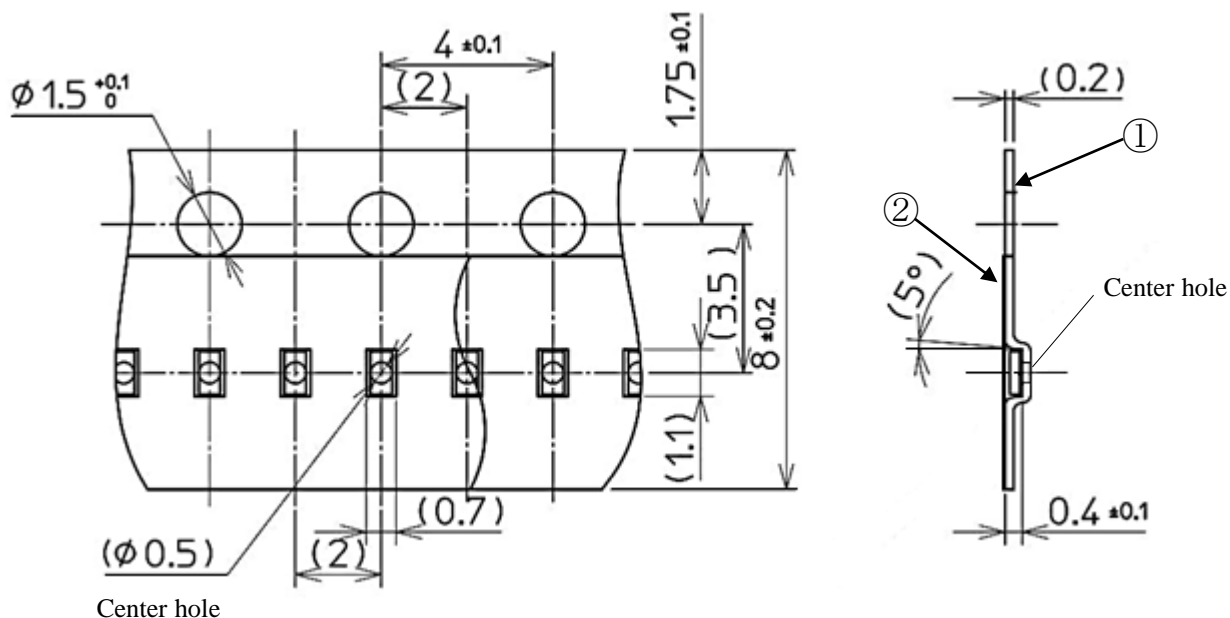

## 【Reel Dimensions】

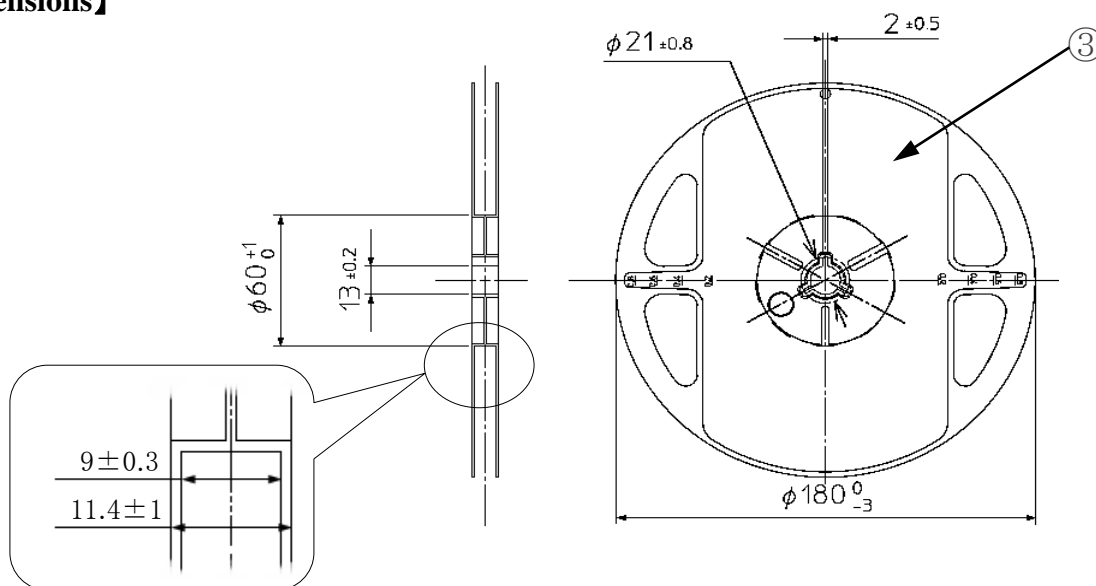

NO.	PART NAME	REMARKS
①	Carrier-tape	Anti-Static Grade
②	Cover-tape	Anti-Static Grade
③	Carrier-reel	Anti-Static Grade

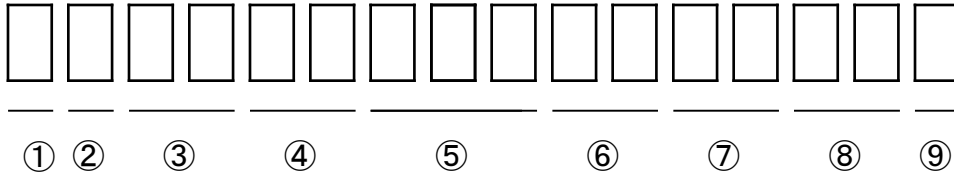

① - 1digit : Production location (mark identify alphabet)

② - 1digit : Production year (the last digit of production year 2025→5, 2026→6, 2027→7, 2028→8 ...)

③ - 2digits : Production month (Jan. to Sep. ,should be 01,02,03 ...)

④ - 2digits : Production date

⑤ - 3digits : Serial number

⑥ - 2digits : Tape and reel following number

⑦ - 2digits : Radiant intensity rank.

(If radiant intensity rank is 1 digit, "-" shall be dashed on the place for the second digit.  
If there is no identified intensity rank, "- -" is used to indicate.)

⑧ - 2digits : Color / chromaticity rank

(If color / chromaticity rank is 1 digit, "-" shall be dashed on the place for the second digit.  
If there is no identified intensity rank, "- -" is used to indicate.)

⑨ - 1digit : Option rank (Stanley normally print "-" to indicate)

This product is in compliance with RoHS2 / ELV.

Prohibition substance and its criteria value of RoHS2 / ELV are as follows.

- RoHS2 instruction ... Refer to following 1 to 10.
- ELV instruction ... Refer to following 1 to 4.

2011/65/EU, (EU)2015/863

No.	Substance group name	Maximum permissible concentration value
1	Lead and its compounds	1,000ppm (0.1%)
2	Cadmium and its compounds	100ppm (0.01%)
3	Mercury and its compounds	1,000ppm (0.1%)
4	Hexavalent chromium compounds	1,000ppm (0.1%)
5	PBB : Polybrominated Biphenyls	1,000ppm (0.1%)
6	PBDE : Polybrominated Biphenyl Ethers	1,000ppm (0.1%)
7	DEHP : Bis (2-ethylhexyl) phthalate	1,000ppm (0.1%)
8	BBP : Butyl benzyl phthalate	1,000ppm (0.1%)
9	DBP : Dibutyl phthalate	1,000ppm (0.1%)
10	DIBP : Diisobutyl phthalate	1,000ppm (0.1%)

## 1. Reliability Testing Result

Test Item	Reference Standard	Test Condition	Duration	Failure
Room Temperature Operating Life	EIAJ ED-4701/100(101)	Ta = 25°C, I <sub>F</sub> = 20mA	1,000 h	0/20
High Temperature Operating Life	EIAJ ED-4701/100(101)	Ta = 85°C, I <sub>F</sub> = 8mA	1,000 h	0/20
Low Temperature Operating Life	EIAJ ED-4701/100(101)	Ta = -40°C, I <sub>F</sub> = 20mA	1,000 h	0/20
Wet High Temperature Operating Life	EIAJ ED-4701/100(102)	Ta = 60°C, RH = 90±5%, I <sub>F</sub> = 14.6mA	1,000 h	0/20
Thermal Shock	EIAJ ED-4701/100(105)	Ta = -40°C to 100°C(each 15min)	1,000 cycles	0/20
Resistance to Reflow Soldering	EIAJ ED-4701/300(301)	Moisture Soak : 30°C 70% 96h Preheating: 150 to 180°C 120sec Max Soldering: 260 Peak	2times	0/20
Electrostatic Discharge(ESD)	EIAJ ED-4701/300(304)	C=100pF R2=1.5kΩ±1,000V	once of each polarity	0/20

## 2. Failure Criteria

Item	Symbol	Condition	Failure Criteria
Luminous Intensity	I <sub>v</sub>	I <sub>F</sub> =5mA	Testing Min. Value < Standard Min. Value × 0.5
Forward Voltage	V <sub>F</sub>	I <sub>F</sub> =5mA	Testing Max. Value ≥ Standard Max. Value × 1.2
External appearance	-	-	Notable discoloration, deformation and cracking

## Special Notice to Customers Using the Products and Technical Information Shown in This Data Sheet

- 1) The technical information shown in the data sheets are limited to the typical characteristics and circuit examples of the referenced products. It does not constitute the warranting of industrial property nor the granting of any license.
- 2) For the purpose of product improvement, the specifications, characteristics and technical data described in the data sheets are subject to change without prior notice. Therefore it is recommended that the most updated specifications be used in your design.
- 3) When using the products described in the data sheets, please adhere to the maximum ratings for operating voltage, heat dissipation characteristics, and other precautions for use. We are not responsible for any damage which may occur if these specifications are exceeded.
- 4) The products that have been described to this catalog are manufactured so that they will be used for the electrical instrument of the benchmark (OA equipment, telecommunications equipment, AV machine, home appliance and measuring instrument).  
The application of aircrafts, space borne application, transportation equipment, medical equipment and nuclear power control equipment, etc. needs a high reliability and safety, and the breakdown and the wrong operation might influence the life or the human body. Please consult us beforehand if you plan to use our product for the usages of aircrafts, space borne application, transportation equipment, medical equipment and nuclear power control equipment, etc. except OA equipment, telecommunications equipment, AV machine, home appliance and measuring instrument.
- 5) In order to export the products or technologies described in this data sheet which are under the “Foreign Exchange and Foreign Trade Control Law,” it is necessary to first obtain an export permit from the Japanese government.
- 6) No part of this data sheet may be reprinted or reproduced without prior written permission from Stanley Electric Co., Ltd.
- 7) The most updated edition of this data sheet can be obtained from the address below:  
<http://www.stanley-components.com/en>