





Illuminating seals, square design

Product range overview

Function	Design	Type	For plug socket	For plug socket with cable	For solenoid coil (valves with solenoid coil)	→ Page/Internet
Illuminating seal		MF-LD	MSSD-F	KMF	For F solenoid coil Tiger 2000 Solenoid valves to ISO 5599-1 (VSVA) Solenoid valves to ISO 5599-1 Solenoid coils MSF Tiger Classic	3
		MC-LD	MSSD-C	KMC	For D solenoid coil, N1 solenoid coil MS-START-UP exhaust valves (on-off valves MS) Solenoid valves to ISO 5599-1 (VSVA) Solenoid valves to ISO 5599-1 Solenoid coils MSN1 Solenoid valves MN1H-MS, brass design	3
		MV-LD-12-24DC	MSSD-V	KMV	For V solenoid coil Tiger 2000	3
		ME-LD-12-24DC	MSSD-E	KME	For E solenoid coil Solenoid valves MEH/MEBH, midi pneumatic	3
		MEB-LD	MSSD-EB	KMEB	For EB solenoid coil, N2 solenoid coil MS-START-UP exhaust valves (on-off valves MS)	3

Illuminating seals, square design

Technical data

Illuminating seal

- MF-LD
- MC-LD
- MV-LD
- ME-LD
- MEB-LD

Illuminating seals are mounted between the plug socket and solenoid coil. The sealing lip points to the coil side, the label to the device socket. The seal is illuminated yellow after the power is switched on.



General technical data			12 ... 24 V DC	230 V AC
Operating voltage			12 ... 24 V DC	230 V AC
Operating voltage range	[V DC]		12 ... 24	–
Nominal operating voltage AC	[V AC]		–	230±10%
Protective circuit, max. switch-off voltage	[V DC]		yes, 50	–
Degree of contamination			–	3
Switching position display			LED (yellow)	LED (yellow)
Rated output of illuminating seal	[mW]		50	330
Impulse withstand voltage	MF-LD	[kV]	–	4
	MC-LD	[kV]	–	4
	MEB-LD	[kV]	–	2.5
Electrical connection			To EN 175301-803	
Protective earth conductor connection			Yes	
Type of mounting	MF-LD		On solenoid valve via M3 central screw	
	MC-LD		On solenoid valve via M3 central screw	
	MV-LD		On solenoid valve via M3 central screw	
	ME-LD		On solenoid valve via M3 central screw	
	MEB-LD		On solenoid valve via M2.5 central screw	
Housing material			TPE-U (PU)	
Protection class to EN 60529			IP65 (in assembled state)	

Operating and environmental conditions			12 ... 24 V DC	230 V AC
Operating voltage			12 ... 24 V DC	230 V AC
Ambient temperature	[°C]		–25 ... +85	–25 ... +85
CE marking (see declaration of conformity)			–	In accordance with EU Low Voltage Directive

Circuit diagram

12 ... 24 V DC

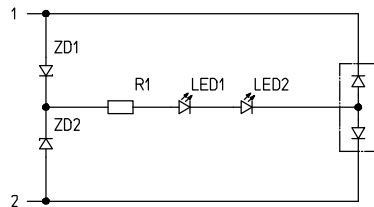

230 V AC

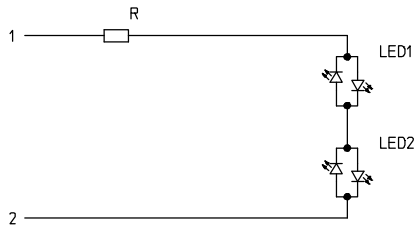

Illuminating seals, square design

Technical data

Installation of the illuminating seal

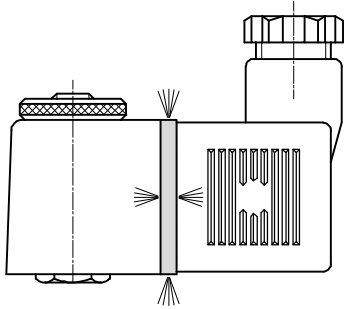

Note





The original seal must be removed before the illuminating seal is installed.

The sealing surface of the illuminating seal must point towards the plug socket, and the sealing rim towards the solenoid coil.

The illuminating seal is intended to be installed once.

Reusing illuminating seals can impair their function.

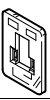
Ordering data

Illuminating seal for		Electrical connection to EN 175301-803	Design, square	Product weight [g]	Max. tightening torque [Nm]	Operating voltage [V]	Part No.	Type
	F solenoid coils	-	MSF	1.6	0.6	12 ... 24 DC	19143	MF-LD-12-24DC
						230 AC	19144	MF-LD-230AC
	D and N1 solenoid coils	■	Type A, MSC	1.6	0.6	12 ... 24 DC	19145	MC-LD-12-24DC
						230 AC	19146	MC-LD-230AC
	V solenoid coils	■	Type B, MSV	1.6	0.35	12 ... 24 DC	35558	MV-LD-12-24DC
	E solenoid coils	-	MSE	0.6	0.35	12 ... 24 DC	19141	ME-LD-12-24DC
	EB solenoid coils	■	Type C, MSEB	0.6	0.5	12 ... 24 DC	151717	MEB-LD-12-24DC
						230 AC	151718	MEB-LD-230AC

Festo - Your Partner in Automation



1 Festo Inc.

5300 Explorer Drive
Mississauga, ON L4W 5G4
Canada

Festo Customer Interaction Center

Tel: 1 877 463 3786
Fax: 1 877 393 3786
Email: customer.service.ca@festo.com

2 Festo Pneumatic

Av. Ceylán 3,
Col. Tequesquináhuac
54020 Tlalnepantla,
Estado de México

Multinational Contact Center

01 800 337 8669
ventas.mexico@festo.com

3 Festo Corporation

1377 Motor Parkway
Suite 310
Islandia, NY 11749

Festo Customer Interaction Center

1 800 993 3786
1 800 963 3786
customer.service.us@festo.com

4 Regional Service Center

7777 Columbia Road
Mason, OH 45040

Connect with us



www.festo.com/socialmedia



www.festo.com