

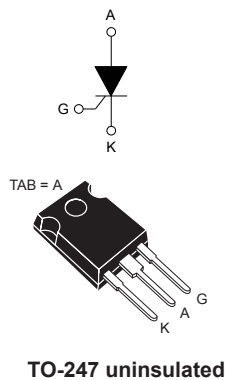

50 A 1200 V automotive grade thyristor (SCR)



Features

- AEC-Q101 qualified 
- Blocking voltage: +/- 1200 V
- On-state current: 50 A_{RMS}
- High static and dynamic commutation:
 - $di/dt = 200 \text{ A}/\mu\text{s}$
 - $dV/dt = 1000 \text{ V}/\mu\text{s}$
- $I_{GT} = 50 \text{ mA}$
- ECOPACK2 compliant component

Applications

- Automotive applications: on board and off board battery charger
- Renewable energy inverters
- Solid state relay
- Overvoltage crowbar protection
- UPS (uninterruptible power supply)
- Bypass SSR / hybrid relay
- Inrush current limiter in battery charger
- AC-DC voltage controlled rectifier
- Industrial welding systems

Description

Available in TO-247 high power package, the TN5050H-12WY autograde is suitable in applications such as automotive / stationary battery charger, renewable energy generator, interruptible power supply, solid state relay, welding equipment and motor drive applications.

Its power switching, voltage robustness and power dissipation performances are the key features for functions such as a 80 A AC switch, an AC phasing inverter and an AC-DC controlled rectifier bridge.

The TN5050H-12WY is an automotive grade product and offers a superior performance in surge current handling, thermal cooling capabilities and overvoltage robustness.

Product status	
TN5050H-12WY	
Product summary	
$I_{T(RMS)}$	50 A
V_{DRM}/V_{RRM}	1200 V
V_{DSM}/V_{RSM}	1300 V
I_{GT}	50 mA
T_j	150 °C

1 Characteristics

Table 1. Absolute ratings (limiting values)

Symbol	Parameter		Value	Unit
$I_{T(RMS)}$	RMS on-state current (180 ° conduction angle)		50	A
$I_{T(AV)}$	Average on-state current (180 ° conduction angle)			
$I_{T(RMS)}$	RMS on-state current (180 ° conduction angle)		80	A
$I_{T(AV)}$	Average on-state current (180 ° conduction angle)			
$I_{TSM}^{(1)}$	Non repetitive surge peak on-state current, $V_R = 0$ V	$t_p = 8.3$ ms	633	A
		$t_p = 10$ ms		
V_{DRM} / V_{RRM}	Repetitive off-state voltage (50-60 Hz)		1200	V
di/dt	$I_G = 2 \times I_{GT}$, $t_r \leq 100$ ns Critical rate of rise of on-state current	$f = 50$ Hz	200	A/ μ s
I_{GM}	Peak forward gate current	$t_p = 20$ μ s	8	A
$P_{G(AV)}$	Average gate power dissipation		1	W
T_{stg}	Storage junction temperature range		-40 to +150	°C
T_j	Operating junction temperature		-40 to +150	°C

1. ST recommend I^2t value for fusing = 1680 A²s for $T_j = 25$ °C and $t_p = 10$ ms

Table 2. Electrical characteristics ($T_j = 25$ °C unless otherwise specified)

Symbol	Test Conditions		Value	Unit	
I_{GT}	$V_D = 12$ V, $R_L = 33$ Ω	Min.	10	mA	
		Max.	50		
V_{GT}	$V_D = 12$ V, $R_L = 33$ Ω	Max.	1	V	
V_{GD}	$V_D = 2/3 \times V_{DRM}$, $R_L = 3.3$ k Ω	$T_j = 150$ °C	Min.	0.15	V
I_H	$I_T = 500$ mA, gate open		Max.	100	mA
I_L	$I_G = 1.2 \times I_{GT}$		Max.	125	mA
t_{gt}	$I_T = 50$ A, $V_D = V_{DRM}$, $I_G = 200$ mA, $di_G/dt = 0.2$ A/ μ s		Typ.	3	μ s
dV/dt	$V_D = 2/3 \times V_{DRM}$, gate open	$T_j = 150$ °C	Min.	1000	V/ μ s
t_q	$I_T = 33$ A, $di_T/dt = 10$ A/ μ s, $V_R = 75$ V, $V_D = 800$ V, $dV_D/dt = 20$ V/ μ s, $t_p = 100$ μ s	$T_j = 150$ °C	Typ.	150	μ s
V_{TM}	$I_{TM} = 100$ A, $t_p = 380$ μ s		Max.	1.55	V
V_{TO}	On-state threshold voltage	$T_j = 150$ °C	Max.	0.88	V
R_D	On-state dynamic resistance	$T_j = 150$ °C	Max.	6	m Ω
I_{DRM}/I_{RRM}	$V_D = V_{DRM}$, $V_R = V_{RRM}$	$T_j = 25$ °C	Max.	5	μ A
		$T_j = 125$ °C	Max.	3	mA
		$T_j = 150$ °C	Max.	7.5	mA
I_{DSM}/I_{RSM}	$V_D = V_{DSM}$, $V_R = V_{RSM}$	$T_j = 25$ °C	Max.	10	μ A

Table 3. Thermal parameters

Symbol	Parameter		Value	Unit
$R_{th(j-c)}$	Junction to case (DC, max.)	TO-247	0.3	°C/W
$R_{th(j-a)}$	Junction to ambient (typ.)		50	

1.1 Characteristics curves

Figure 1. Maximum average power dissipation versus average on-state current

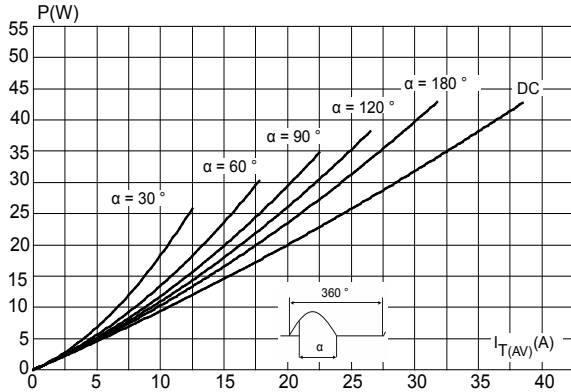

Figure 2. Correlation between maximum average power dissipation and maximum allowable temperatures (T_{amb} and T_{case})

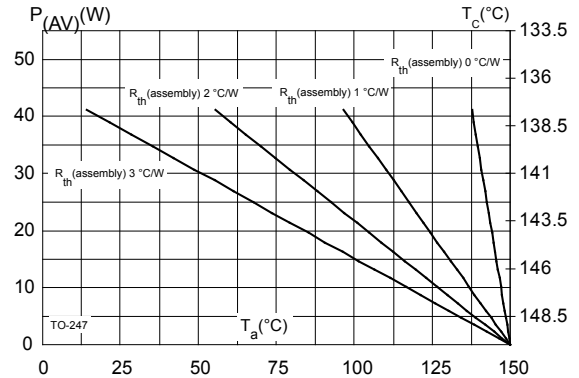

Figure 3. Average and DC on-state current versus case temperature

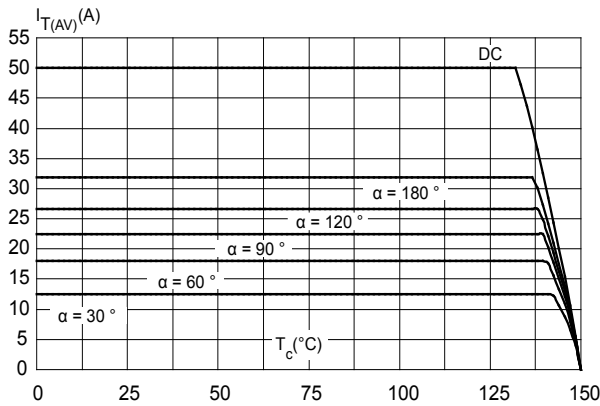

Figure 4. Average and D.C. on-state current versus ambient temperature

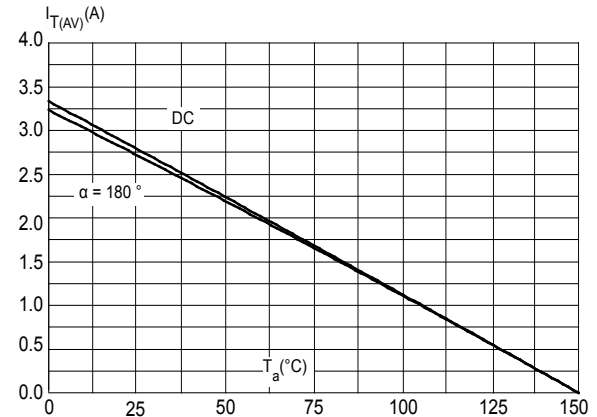

Figure 5. Relative variation of thermal impedance junction to case and junction to ambient versus pulse duration

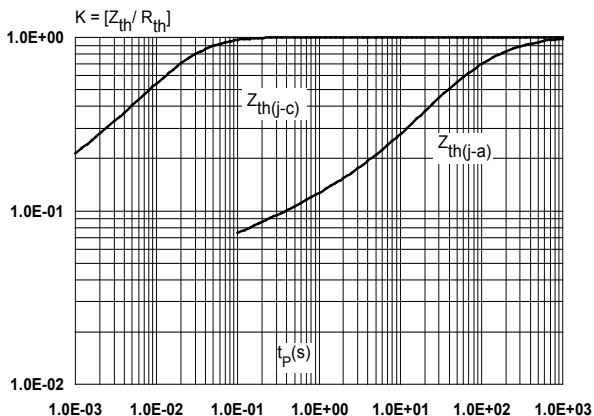

Figure 6. Relative variation of gate trigger current and gate voltage versus junction temperature (typical values)

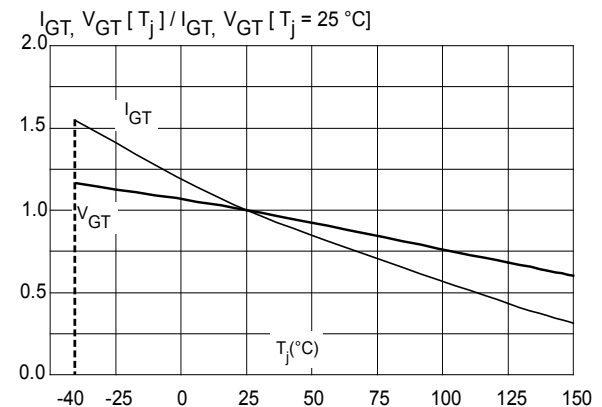

Figure 7. Relative variation of holding and latching current versus junction temperature (typical values)

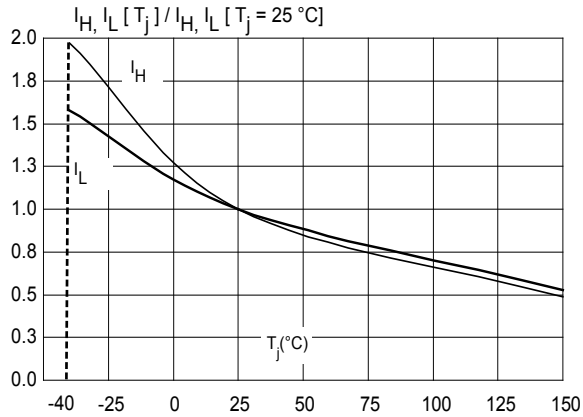

Figure 8. Surge peak on-state current versus number of cycles

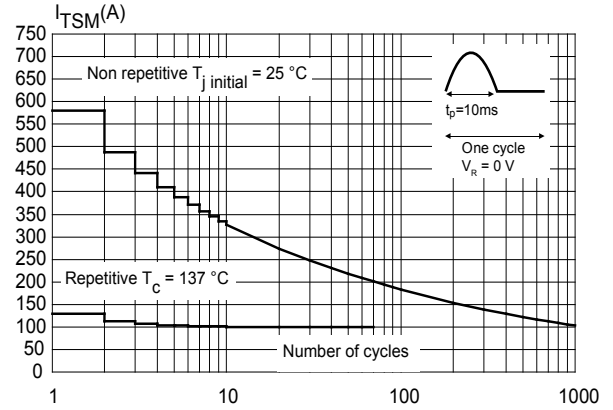

Figure 9. Non repetitive surge peak on-state current for a sinusoidal pulse ($t_p < 10$ ms)

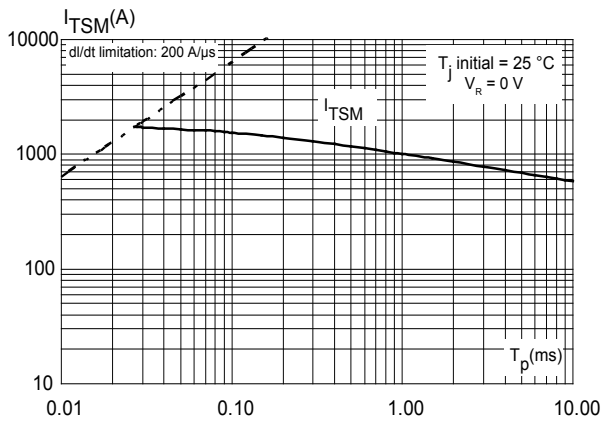

Figure 10. On-state characteristics (maximum values)

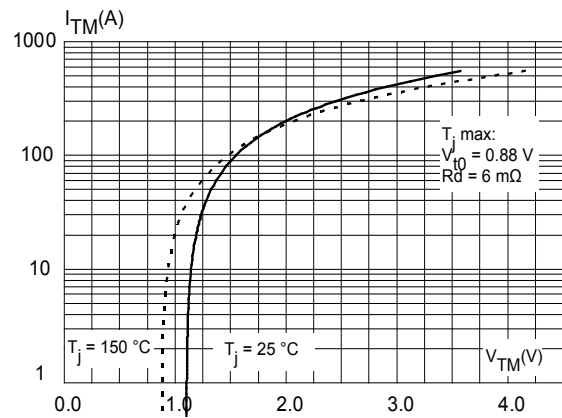
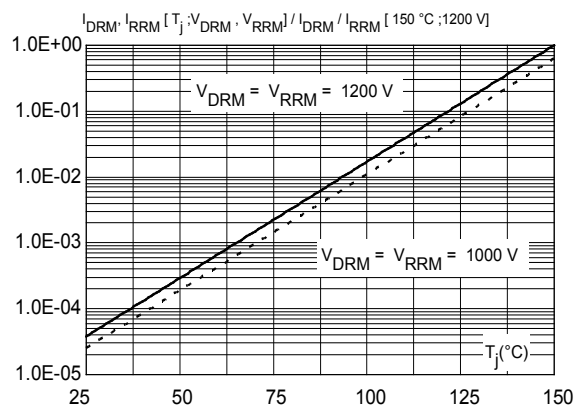

Figure 11. Relative variation of leakage current versus junction temperature for different values of blocking voltage (typical values)



2 Package information

In order to meet environmental requirements, ST offers these devices in different grades of **ECOPACK** packages, depending on their level of environmental compliance. ECOPACK specifications, grade definitions and product status are available at: www.st.com. ECOPACK is an ST trademark.

2.1 TO-247 package information

- Epoxy meets UL 94,V0
- Recommended torque value: 0.8 N·m
- Maximum torque value: 1 N·m

Figure 12. TO-247 package outline

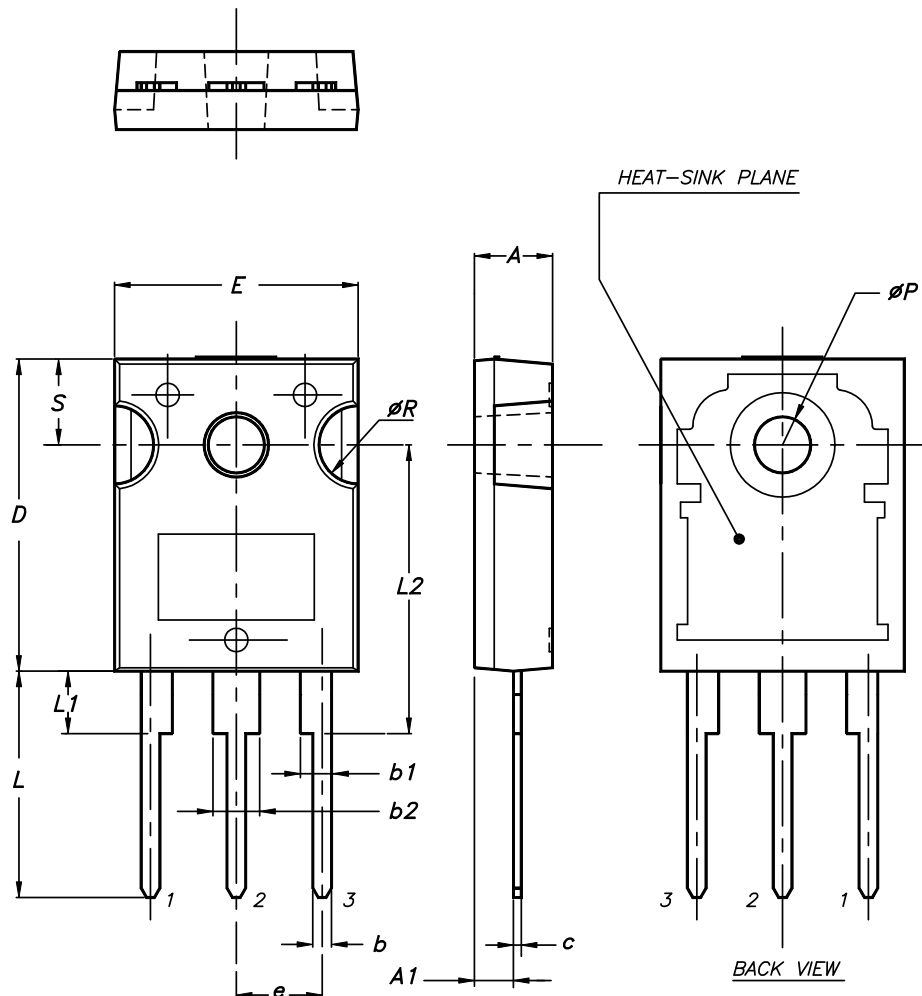

0075325_9

Table 4. TO-247 package mechanical data

Dim.	Dimensions					
	Millimeters			Inches ⁽¹⁾		
	Min.	Typ.	Max.	Min.	Typ.	Max.
A	4.85		5.15	0.1909		0.2028
A1	2.20		2.60	0.0866		0.1024
b	1.0		1.40	0.0394		0.0551
b1	2.0		2.40	0.0787		0.0945
b2	3.0		3.40	0.1181		0.1339
c	0.40		0.80	0.0157		0.0315
D ⁽²⁾	19.85		20.15	0.7815		0.7933
E	15.45		15.75	0.6083		0.6201
e	5.30	5.45	5.60	0.2087	0.2146	0.2205
L	14.20		14.80	0.5591		0.5827
L1	3.70		4.30	0.1457		0.1693
L2		18.50			0.7283	
ØP ⁽³⁾	3.55		3.65	0.1398		0.1437
ØR	4.50		5.50	0.1772		0.2165
S	5.30	5.50	5.70	0.2087	0.2165	0.2244

1. Inch dimensions given only for reference
2. Dimension D plus gate protrusion does not exceed 20.5 mm
3. Resin thickness around the mounting hole is not less than 0.9 mm

3 Ordering information

Table 5. Ordering information

Order code	Marking	Package	Weight	Base qty.	Delivery mode
TN5050H-12WY	TN5050H12Y	TO-247	4.43 g	30	Tube

Revision history

Table 6. Document revision history

Date	Revision	Changes
07-Jan-2015	1	Initial release.
17-Oct-2017	2	Updated TO-247 package information.
20-Dec-2017	3	Updated Table 5: "TO-247 package mechanical data".
11-Sep-2019	4	Updated Table 1 and Figure 8. Minor text change.
27-Feb-2020	5	Minor text change to improve the readability of the document.

IMPORTANT NOTICE – PLEASE READ CAREFULLY

STMicroelectronics NV and its subsidiaries (“ST”) reserve the right to make changes, corrections, enhancements, modifications, and improvements to ST products and/or to this document at any time without notice. Purchasers should obtain the latest relevant information on ST products before placing orders. ST products are sold pursuant to ST’s terms and conditions of sale in place at the time of order acknowledgement.

Purchasers are solely responsible for the choice, selection, and use of ST products and ST assumes no liability for application assistance or the design of Purchasers’ products.

No license, express or implied, to any intellectual property right is granted by ST herein.

Resale of ST products with provisions different from the information set forth herein shall void any warranty granted by ST for such product.

ST and the ST logo are trademarks of ST. For additional information about ST trademarks, please refer to www.st.com/trademarks. All other product or service names are the property of their respective owners.

Information in this document supersedes and replaces information previously supplied in any prior versions of this document.

© 2020 STMicroelectronics – All rights reserved

Mouser Electronics

Authorized Distributor

Click to View Pricing, Inventory, Delivery & Lifecycle Information:

[STMicroelectronics:](#)

[TN5050H-12WY](#) [TN5050H-12WL](#)