

SINGLE PHASE HALL EFFECT LATCH**AH477A****General Description**

The AH477A is an integrated Hall sensor with H-bridged output driver designed for brushless DC motor applications. The device includes an on-chip Hall sensor for magnetic sensing, an amplifier that amplifies the Hall voltage, a comparator to provide switching hysteresis for noise rejection, a bi-directional drivers for sinking and driving large current load. It also includes an internal bandgap regulator to provide temperature compensated bias for internal circuits and allows a wide operating supply voltage range.

Placing the device in a variable magnetic field, if the magnetic flux density is larger than threshold B_{OP} , the DO is turned to sink and DOB is turned to drive. This output state is held until the magnetic flux density reverses and falls below B_{RP} , then causes DO to be turned to drive and DOB turned to sink.

The AH477A is available in TO-94 (SIP-4L) package.

Features

- On-Chip Hall Sensor
- Operating Voltage: 3.5V to 18V
- H-Bridge Output Drivers for Single Coil
- Internal Bandgap Regulator for Temperature Compensation
- Low Output Switching Current Noise
- Operating Temperature: -20°C to 85°C
- Low Profile TO-94 (SIP-4L) Package
- ESD Rating: 6000V (Human Body Model)
- Suitable for PWM Power Supply Control Speed

Applications

- Single-coil Brushless DC Motor
- Single-coil Brushless DC Fan

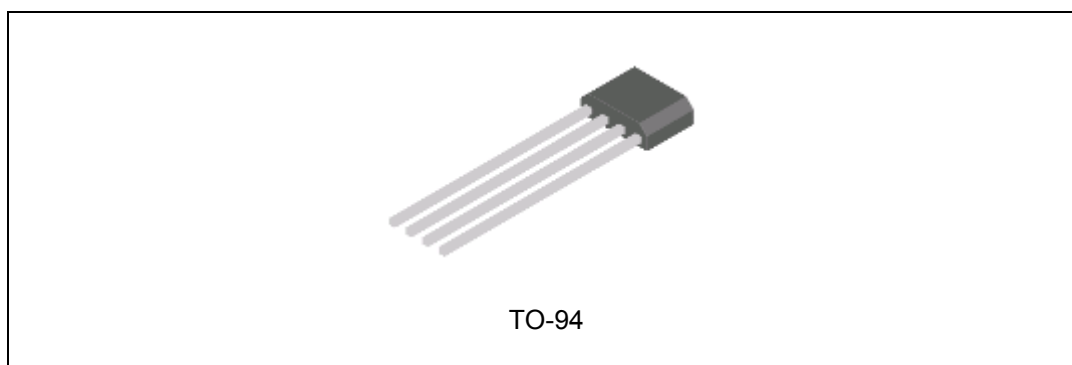

Figure 1. Package Type of AH477A

SINGLE PHASE HALL EFFECT LATCH

AH477A

Pin Configuration

Z4 Package
(TO-94)

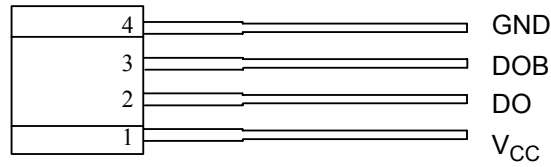

Figure 2. Pin Configuration of AH477A (Front View)

Pin Description

Pin Number	Pin Name	Function
1	V _{CC}	Supply voltage
2	DO	Output 1
3	DOB	Output 2
4	GND	Ground

**SINGLE PHASE HALL EFFECT LATCH****AH477A****Absolute Maximum Ratings (Note 1)** $(T_A=25^{\circ}\text{C})$

Parameter	Symbol	Value	Unit
Supply Voltage	V_{CC}	20	V
Magnetic Flux Density	B	Unlimited	Gauss
Output Current	Continuous	250	mA
	Hold	300	mA
	Peak (start up)	600	mA
Power Dissipation	P_D	550	mW
Thermal Resistance	Die to atmosphere	θ_{JA}	227 $^{\circ}\text{C}/\text{W}$
	Die to package case	θ_{JC}	49 $^{\circ}\text{C}/\text{W}$
Storage Temperature	T_{STG}	-50 to 150	$^{\circ}\text{C}$
ESD (Machine Model)		600	V
ESD (Human Body Model)		6000	V

Note 1: Stresses greater than those listed under "Absolute Maximum Ratings" may cause permanent damage to the device. These are stress ratings only, and functional operation of the device at these or any other conditions beyond those indicated under "Recommended Operating Conditions" is not implied. "Absolute Maximum Ratings" for extended period may affect device reliability.

Recommended Operating Conditions $(T_A=25^{\circ}\text{C})$

Parameter	Symbol	Min	Max	Unit
Supply Voltage	V_{CC}	3.5	18	V
Frequency (PWM Power)	f	0.1	25	kHz
Ambient Temperature	T_A	-20	85	$^{\circ}\text{C}$



SINGLE PHASE HALL EFFECT LATCH

AH477A

Electrical Characteristics

($T_A=25^{\circ}C$, $V_{CC}=14V$, unless otherwise specified)

Parameter	Symbol	Test Condition	Min	Typ	Max	Unit
Output Saturation Voltage (Sink)	V_{SAT}	$V_{CC}=14V, I_O=200mA$		0.45	0.65	V
Output Saturation Voltage (Drive)		$V_{CC}=14V, I_O=200mA$	$V_{CC}-1.3$	$V_{CC}-1.0$	V_{CC}	V
Supply Current	I_{CC}	$V_{CC}=20V$, Output Open		13.5	16	mA
Output Rise Time	t_r	$R_L=820\Omega, C_L=20pF$		0.5	1.0	μs
Output Fall Time	t_f	$R_L=820\Omega, C_L=20pF$		0.5	1.0	μs

Magnetic Characteristics

($T_A=25^{\circ}C$)

Parameter	Symbol	Grade	Min	Typ	Max	Unit
Operating Point	B_{OP}	A	5		70	Gauss
		B			100	
Releasing Point	B_{RP}	A	-70		-5	Gauss
		B	-100			
Hysteresis	B_{HYS}			70		Gauss

Test Circuit

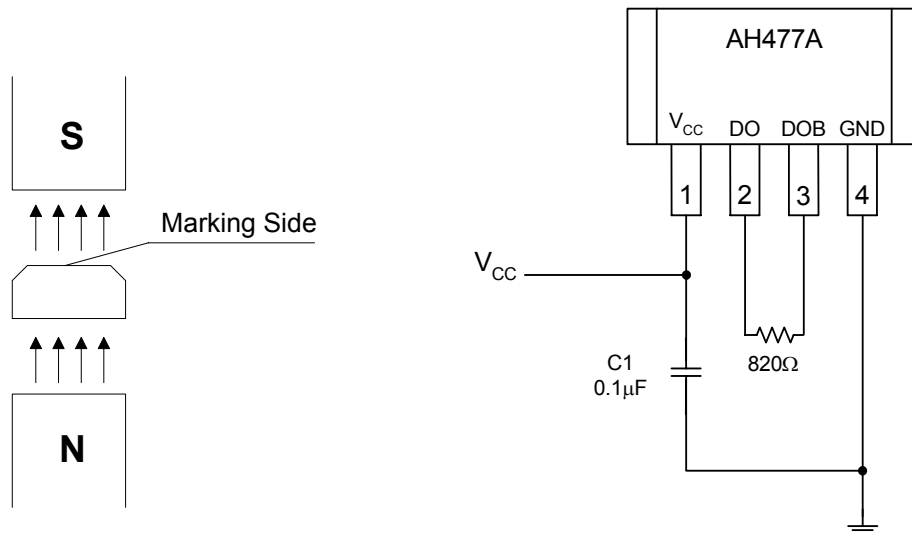



SINGLE PHASE HALL EFFECT LATCH

AH477A

Magnetic Hysteresis Characteristics

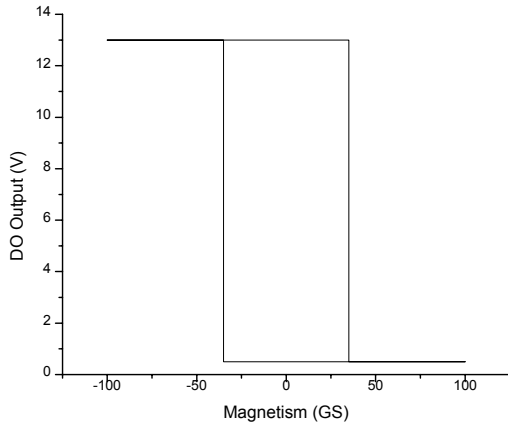

Figure 4. DO Output vs. Magnetism

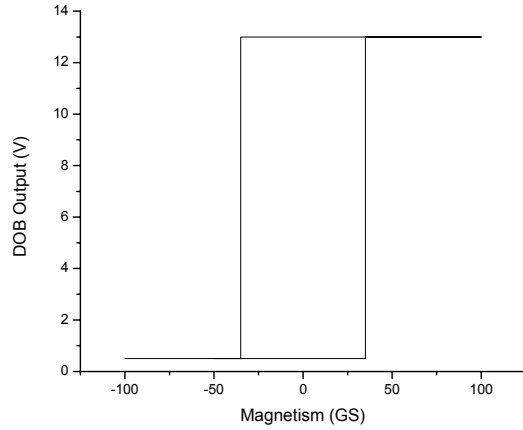

Figure 5. DOB Output vs. Magnetism

Typical Performance Characteristics

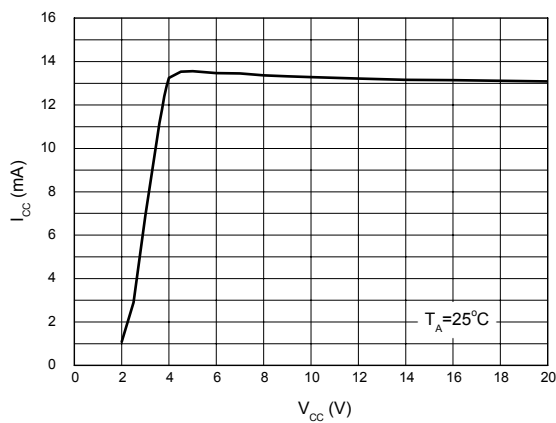

Figure 6. Supply Current vs. Supply Voltage

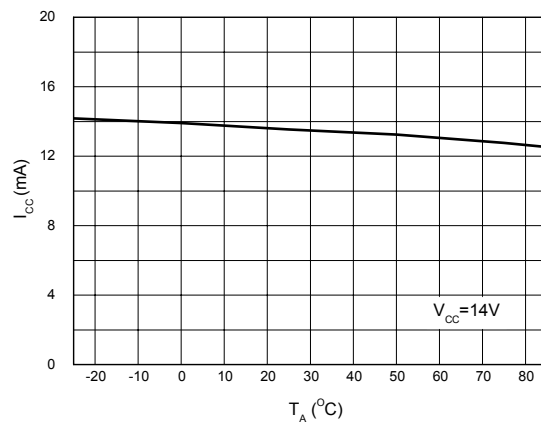

Figure 7. Supply Current vs. Ambient Temperature



SINGLE PHASE HALL EFFECT LATCH

AH477A

Typical Performance Characteristics (Continued)

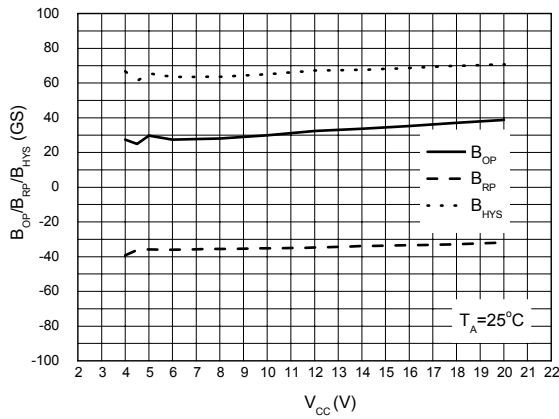

Figure 8. $B_{OP}/B_{RP}/B_{HYS}$ vs. Supply Voltage

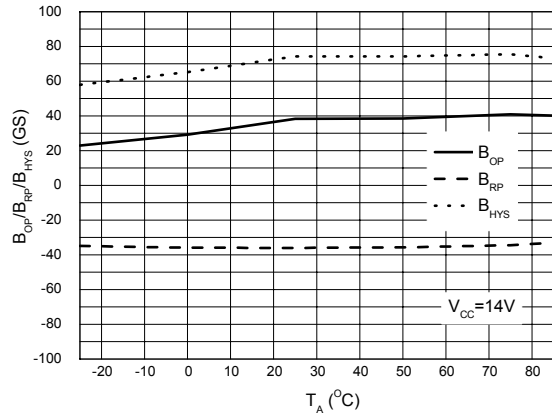

Figure 9. $B_{OP}/B_{RP}/B_{HYS}$ vs. Ambient Temperature

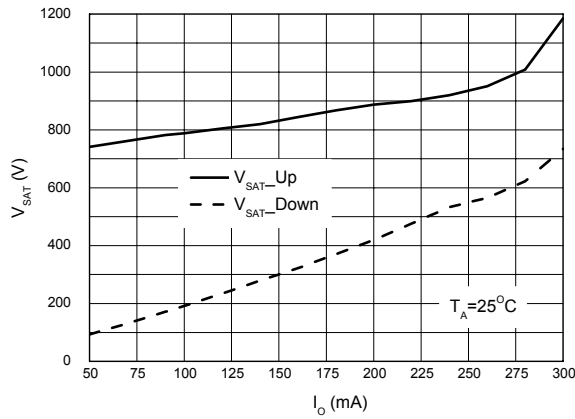

Figure 10. V_{SAT} vs. I_O

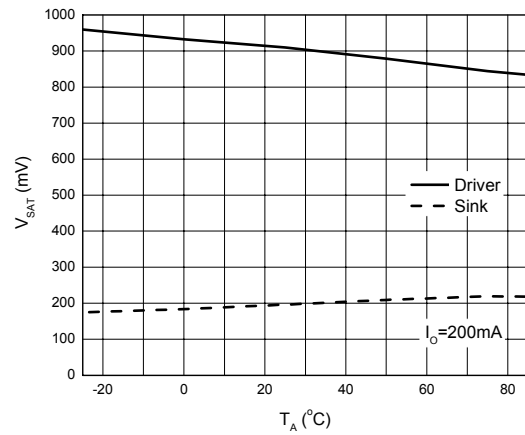

Figure 11. V_{SAT} vs. Ambient Temperature

SINGLE PHASE HALL EFFECT LATCH

AH477A

Typical Performance Characteristics (Continued)

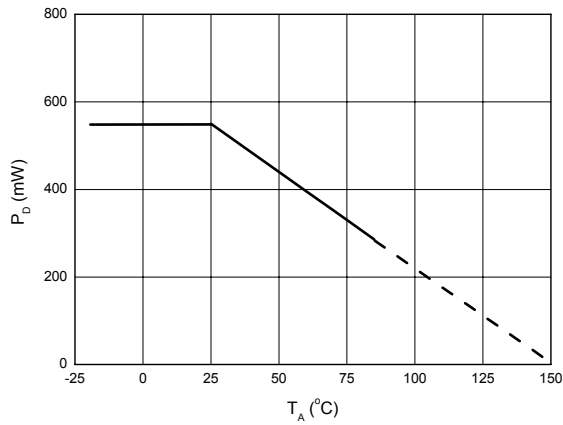

Figure 12. P_D vs. Ambient Temperature

Typical Application

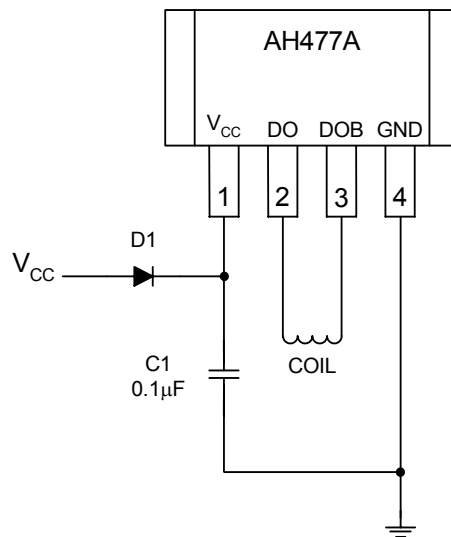

Figure 13. Typical Application Circuit



SINGLE PHASE HALL EFFECT LATCH

AH477A

Mechanical Dimensions

TO-94

Unit: mm(inch)

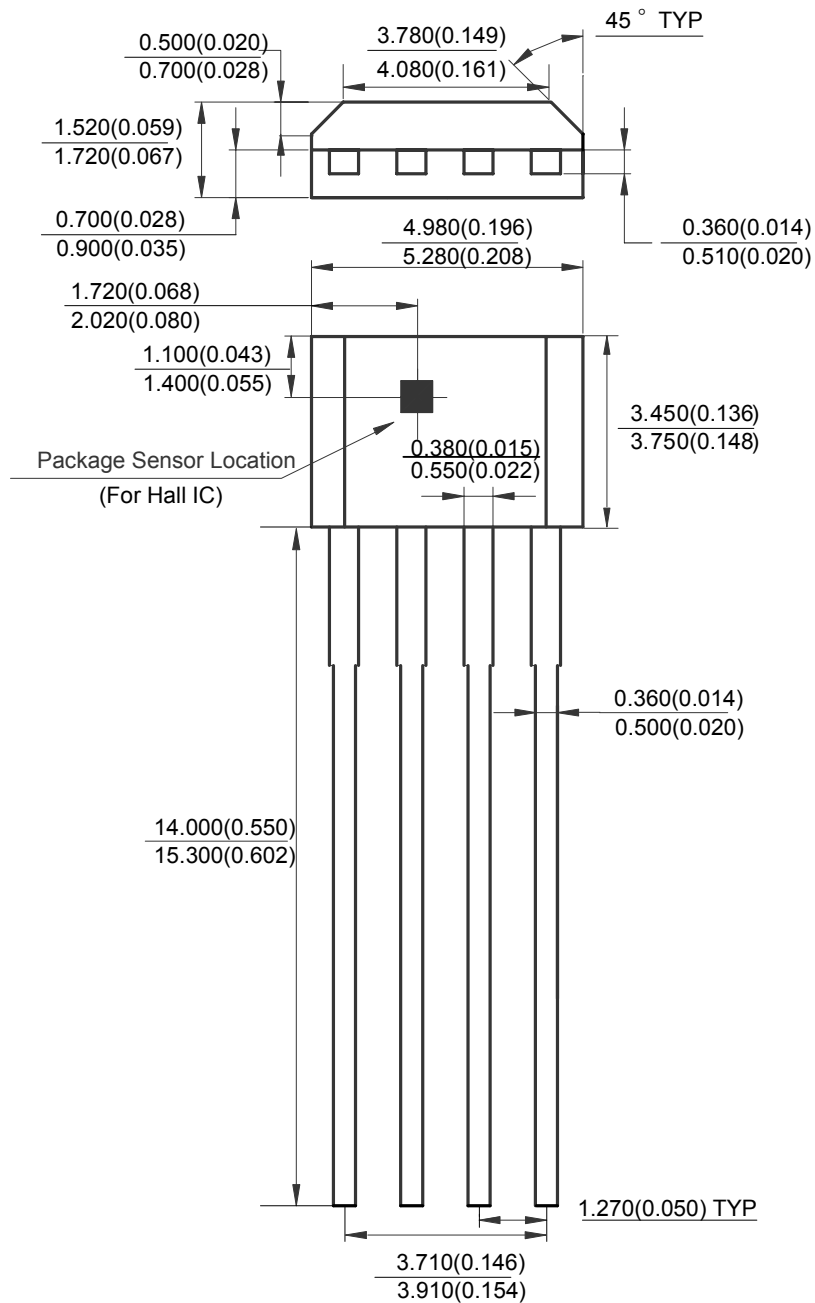



BCD Semiconductor Manufacturing Limited

<http://www.bcdsemi.com>

IMPORTANT NOTICE

BCD Semiconductor Manufacturing Limited reserves the right to make changes without further notice to any products or specifications herein. BCD Semiconductor Manufacturing Limited does not assume any responsibility for use of any its products for any particular purpose, nor does BCD Semiconductor Manufacturing Limited assume any liability arising out of the application or use of any its products or circuits. BCD Semiconductor Manufacturing Limited does not convey any license under its patent rights or other rights nor the rights of others.

MAIN SITE

- Headquarters

BCD Semiconductor Manufacturing Limited

No. 1600, Zi Xing Road, Shanghai Zizhu Science-based Industrial Park, 200241, China
Tel: +86-21-24162266, Fax: +86-21-24162277

- Wafer Fab

Shanghai SIM-BCD Semiconductor Manufacturing Co., Ltd.

800 Yi Shan Road, Shanghai 200233, China
Tel: +86-21-6485 1491, Fax: +86-21-5450 0008

REGIONAL SALES OFFICE

Shenzhen Office

Shanghai SIM-BCD Semiconductor Manufacturing Co., Ltd., Shenzhen Office

Unit A Room 1203, Skyworth Bldg., Gaoxin Ave. 1.S., Nanshan District, Shenzhen, China
Tel: +86-755-8826 7951
Fax: +86-755-8826 7865

Taiwan Office

BCD Semiconductor (Taiwan) Company Limited

4F, 298-1, Rui Guang Road, Nei-Hu District, Taipei, Taiwan
Tel: +886-2-2656 2808
Fax: +886-2-2656 2806

USA Office

BCD Semiconductor Corp.

30920 Huntwood Ave. Hayward, CA 94544, USA
Tel : +1-510-324-2988
Fax: +1-510-324-2788

Mouser Electronics

Authorized Distributor

Click to View Pricing, Inventory, Delivery & Lifecycle Information:

[Diodes Incorporated:](#)

[AH477AZ4-AG1](#) [AH477AZ4-BG1](#)