

ESKA



Erich Schweizer GmbH
Elektrotechnische Fabrik

Geräteschutzsicherungen

Miniature fuses





Wir sind zertifiziert nach
DIN EN ISO 9001:2008



We are certified by
DIN EN ISO 9001:2008

Teilbereiche nach TS 16949

Partition by TS 16949

Allgemeine Erläuterungen / General Notes		2 - 3
G-Sicherungseinsätze / Fuses-links	Übersicht	4 - 9
	Daten	10 - 49
Sortimente / Assortment Boxes	Übersicht	50 - 51
	Daten	52 - 55
Kleinstsicherungen / Subminiature Fuses	Übersicht	56 - 57
	Daten	58 - 67
SMD-Sicherungen / SMD-Fuses	Übersicht	68
	Daten	69 - 76
Chip-Sicherungen / Chip-Fuses	Übersicht	77
	Daten	78 - 91
PTC/CPTC-Sicherungen / PTC/CPTC-Fuses	Daten	92 - 93
Gasableiter / Gas Discharge Tube	Übersicht	94 - 94
	Daten	95 - 99
KFZ-Sicherungen / Car-Fuses	Übersicht	100
Temperatursicherungen / Thermal Cutoffs	Übersicht	101
Sicherungshalter / Fuse-Holders	Übersicht	102 - 105
	Daten	106 - 116
Offene Sicherungshalter / Open Fuse-Holders	Übersicht	117 - 118
	Daten	119 - 125
Haltefedern / Clips For Fuses	Übersicht	126 - 126
	Daten	127 - 128
Baugruppen / Assemblies	Übersicht	129
Vertretungen und Partnerfirmen / Partners international	Daten	130 - 134

Die in diesem Katalog aufgeführten technischen Angaben gelten für die derzeitige Fertigung. Wir behalten uns vor, im Zuge der Weiterentwicklung einzelne Werte innerhalb der in den entsprechenden Normen festgelegten Grenzen zu ändern.

ESKA-G-Sicherungseinsätze und ESKA-G-Sicherungshalter sind das Produkt unserer langjährigen Erfahrung, denn schon vor 1940 unterhielt die Familie des Firmengründers Erich Schweizer eine Fabrikation in Thüringen in der Nähe von Ilmenau.

Geräteschutzsicherungen sind selbsttätig wirkende Unterbrechungsvorrichtungen zum Schutz von elektrischen Geräten gegen Strombelastungen unzulässiger Stärke und Dauer, bei denen der Stromfluss durch Abschmelzen des vom Strom durchflossenen Schmelzleiters unterbrochen wird.

Geräteschutzsicherungen (G-Sicherungen) bestehen aus:

1. G-Sicherungseinsatz
2. Sicherungsunterteil (Sockel)
3. Sicherungseinsatzträger (Schraubkappe, Renkkappe, Steckpappe)
2. und 3. $\hat{=}$ Sicherungshalter

G-Sicherungseinsätze werden in superflinker, flinker, mittelträger, träger und superträger, solche mit Kennmelder nur in flinker und mittelträger Ausführung geliefert.

Im einzelnen gelten die nachfolgenden Internationalen und Nationalen Normen in der jeweils gültigen Fassung:

EN 60127, Teil 1-6
VDE 0820, Teil 1-6
UL 248-14
UL 512
CSA Standard C 22.3 No. 248.14

Begriffe

Die **Bemessungsspannung (Nennspannung)** des G-Sicherungseinsatzes muß mindestens gleich oder größer als die Betriebsspannung des Gerätes oder der Baugruppe sein, für dessen Schutz der Sicherungseinsatz bestimmt ist.

Die Verwendung bei Betriebsspannung unterhalb der Bemessungsspannung ist ohne weiteres möglich. Wenn die Betriebsspannung jedoch sehr niedrig ist, muß u. U. der Eigenwiderstand (Spannungsfall) der G-Sicherungseinsätze berücksichtigt werden.

Der **Bemessungsstrom** des G-Sicherungseinsatzes soll etwa dem Betriebsstrom des zu schützenden Gerätes entsprechen, im Normalbetrieb soll der Bemessungsstrom nicht überschritten werden. Bei erhöhten Einschaltströmen empfiehlt sich die Verwendung mittelträger und träger G-Sicherungseinsätze.

Das **Bemessungsausschaltvermögen** kennzeichnet den Strom bei Nennspannung, der ordnungsgemäß abgeschaltet werden muß, ohne das der G-Sicherungseinsatz zerstört wird oder ein Lichtbogen stehen bleibt. Es ist folglich zu beachten, daß auch im Kurzschlußfall kein größerer Strom fließen darf, als es den Bemessungsausschaltvermögen des G-Sicherungseinsatzes entspricht.

Der **Spannungsfall** der G-Sicherungseinsätze (bei Bemessungsstrom) darf die in den Standards angegebenen Maximalwerte nicht übersteigen.

Superflinke G-Sicherungseinsätze sind als Kurzschlußschutz für Halbleiterbauelemente (Dioden, Thyristoren, Triacs, Quadracs) vorgesehen. Weiter dienen sie zur schnellen Abschaltung von Geräten in Fällen, in denen ein flinker Sicherungseinsatz noch zu langsam ist. Diese Sicherungseinsätze sind nicht genormt.

Flinke G-Sicherungseinsätze werden zum Schutz solcher Geräte verwendet, bei denen beim Einschalten oder im Betrieb keine Stromstöße auftreten, aber hohe Über- oder Kurzschlußströme in kürzester Zeit unterbrochen werden sollen. Häufig werden in Netzkreisen diese Einsätze auch als vorgeschaltete Kurzschlußsicherung benutzt.

Mittelträge G-Sicherungseinsätze werden vornehmlich bei kleineren Betriebsspannungen benutzt, wenn keine großen Einschaltströme zu berücksichtigen sind.

Träge G-Sicherungseinsätze werden verwendet, wenn hohe Einschaltstromstöße auftreten, die nur langsam abklingen, wie z. B. beim Anlaufen belasteter Motoren.

Superträge G-Sicherungseinsätze zeigen bei hoher Überlast eine noch größere Trägheit als G-Sicherungseinsätze mit träger Charakteristik.

Qualitätssicherung

Unser Qualitätssicherungssystem basiert auf der internationalen Norm DIN EN ISO 9001, ist auf die besonderen Anforderungen für Schutzbauelemente zugeschnitten und durch das unabhängige Zertifizierungsinstitut des VDE geprüft und zertifiziert.

Technical data given in this catalogue relate to our present production program and are subject to alteration within the limits of applied standards in case further technical development will require it.

ESKA miniature fuse-links and ESKA fuse holders are the product of our many years of experience since the family of the founder of the company, Erich Schweizer, had a production plant in Thuringia near Illmenau as early as pre-1940.

Miniature fuse-links are self-acting break appliances for protection of electrical devices against unsuitable current load. The current flow is interrupted by the melting of the fuse wire in which the current flows.

Miniature fuse-links are composed of:

1. fuse-link
2. fuse-base
3. fuse-carrier
2. and 3. \triangle fuse-holder

Miniature fuse-links are delivered in very-quick-acting, quick-acting, medium-time-lag, time-lag and super-time-lag characteristics, except those fuse-links with indicator which are either quick-acting or medium-acting.

The following national and international standards are valid for miniature fuse-links:

- EN 60127, part 1-6
- VDE 0820, part 1-6
- UL 248-14
- UL 512
- CSA Standard C 22.3 No. 248.14

Explanations

The **rated voltage** of a fuse-link has to be at least equal or higher than the operating voltage of the device or assembly unit which is to be protected by the fuse-link.

It is possible and allowed to employ a fuse-link with a rated voltage which is higher than the operating voltage. If the operating voltage is very low, fuse-link's natural resistance (voltage drop) must possible be taken into consideration.

The **rated current** should correspond to the approximate working current of the apparatus being protected, in normal operation this current should not be exceeded. In circuits where peaks are expected, medium time-lag or time-lag fuses should be used.

The **rated breaking capacity** is the stated current switching capacity of the device at the stated voltage which, when operation takes place, will not damage the fuse set or allow arcing. It is therefore important to take care that under short circuit conditions the current available should not exceed the rated breaking capacity of the device.

The **voltage drop** of the fuse set at a given current may not exceed the maximum figure shown in the standard.

Very quick-acting fuse-links are specified as short-circuit protection for semi-conductors (diodes, thyristors, triacs, quad-racs). They as well serve the purpose of a quick circuit breaker for devices where a quick-acting miniature fuse-links is still too slow. These fuse-links are not standardized.

Quick-acting fuse-links are used for protection of a device with no current surge when operating of switching on and also for such devices where high overcurrent or high short-circuit current must be interrupted quickly. These fuse-links are as well employed frequently in networks as short-circuit fuse-links connected in series.

Medium time-lag fuse-links are used mainly when only small voltages and switching currents have to be taken in to consideration.

Time-lag fuse-links are employed whenever high initial currents appear which only are dying out slowly, for instance at starting charged engines.

Super time-lag fuse-links are used when the expected surges will be greater than those which surge resisting fuses can accommodate.

Quality assessment

Our quality assessment system is based on the international standard DIN EN ISO 9001 and is tailored to the special requirements for the circuit protection components and certified by the approving authority of VDE.

Bemessungswerte/ Ratings	G - Sicherungseinsätze / Fuse - links			
	Produktfoto / product picture			
Typ / type	5 x 15 515.600	5 x 15 515.300	5 x 20 520.100	5 x 20 520.500
Merkmal / characteristic	F	T	FF	F
Strom / current	100 mA – 6,3 A	250 mA – 6,3 A	100 mA – 12,5 A	50 mA – 10 A
Spannung / voltage	250 V / 125 V	250 V / 125 V	250 V	250 V
Ausschaltvermögen / breaking capacity	35 A – 400 A	35 A – 400 A	35 A / 1500 A	1500 A
Prüfzeichen / approvals				
Norm	Werknorm	Werknorm	Werknorm	DIN 41.660 EN 60127-2-1
Katalogseite / catalogue page	10	11	12	13

Bemessungswerte/ Ratings	G - Sicherungseinsätze / Fuse - links			
	Produktfoto / product picture			
Typ / type	5 x 20 520.600	5 x 20 520.000	UL 5 x 20 UL520.600	5 x 20 521.000
Merkmal / characteristic	F	F	F	M
Strom / current	32 mA – 10 A	1,6 A – 16 A	80 mA - 8 A	32 mA – 20 A
Spannung / voltage	250 V / 125 V	250 V	250 V / 125 V	250 V
Ausschaltvermögen / breaking capacity	35 A- 100 A	250 A / 300 A / 1.000 A	200 A / 10.000 A	80 A / 300 A 1.000 A
Prüfzeichen / approvals				
Norm	DIN 41.661 EN 60127-2-2	DIN 41.571-1	UL No. 248-14	DIN 41.571-2
Katalogseite / catalogue page	14	15	16	17

Bemessungswerte/ Ratings	G - Sicherungseinsätze / Fuse - links			
Produktfoto / product picture				
Typ / type	5 x 20 521.500	UL 5 x 20 UL 521.000	5 x 20 522.700	UL 5 x 20 UL 522.200
Merkmal / characteristic	M	M	T	T
Strom / current	1,6 A – 16 A	100 mA – 5 A	100 mA – 10 A	80 mA – 10 A
Spannung / voltage	250 V	250 V / 125 V	250 V	250 V / 125 V
Ausschaltvermögen / breaking capacity	1500 A	35 A / 100 A / 10.000 A	1500 A	100 A / 1.000 A / 10.000 A
Prüfzeichen / approvals				
Norm	Werknorm	UL No. 248-14	EN 60127-2-5	UL No. 248-14
Katalogseite / catalogue page	18	19	20	21









Bemessungswerte/ Ratings	G - Sicherungseinsätze / Fuse - links			
Produktfoto / product picture				
Typ / type	5 x 20 522.500	5 x 20 522.300	5 x 20 522.000	5 x 20 522.400
Merkmal / characteristic	T	T	T	TT
Strom / current	32 mA – 10 A	32 mA – 10 A	1,6 A – 16 A	100 mA – 10 A
Spannung / voltage	250 V / 125 V	250 V	250 V	250 V
Ausschaltvermögen / breaking capacity	35 A- 100 A	150 A	300 A	35 A
Prüfzeichen / approvals				
Norm	DIN 41.662 EN 60127-2-3	EN 60127-2-6	DIN 41.571-3	Werknorm
Katalogseite / catalogue page	22	23	24	25









Bemessungswerte/ Ratings	G - Sicherungseinsätze / Fuse - links			
Produktfoto / product picture				
Typ / type	5 x 25 525.600	5 x 25 Kennmelder (indicator) 527.000	5 x 25 525.200	5 x 25 Kennmelder(indicator) 528.000
Merkmal / characteristic	F	F	M	M
Strom / current	32 mA – 10 A	1,6 A – 10 A	40 mA – 10 A	80 mA – 16 A
Spannung / voltage	250 V	250 V	250 V	250 V
Ausschaltvermögen / breaking capacity	50 A / 80 A / 100 A	300 A	80 A / 100 A	80 A / 1500 A
Prüfzeichen / Approvals				
Norm	Werknorm	DIN 41.576,1	Werknorm	DIN 41.576,2
Katalogseite / catalogue page	26	27	28	29







Bemessungswerte/ Ratings	G - Sicherungseinsätze / Fuse - links			
Produktfoto / product picture				
Typ / type	5 x 20 /5x 25 /5x30 Kennmelder (indicator) 528.100	5 x 30 530.600	5 x 30 530.200	6,3 x 32 632.100
Merkmal / characteristic	M	F	M	FF
Strom / current	32 mA – 10 A	32 mA – 10 A	32 mA – 10 A	250 mA – 25 A
Spannung / voltage	125 V / 250 V	500 V	500 V	250 V / 500 V
Ausschaltvermögen / breaking capacity	80 A / 1.500 A	50 A / 80 A / 100 A	80 A / 100 A	35 A / 1.500 A
Prüfzeichen / approvals				
Norm	DIN 41577,2	Werknorm	Werknorm	Werknorm
Katalogseite / catalogue page	30	31	32	33

Bemessungswerte/ Ratings	G - Sicherungseinsätze / Fuse - links			
Produktfoto / product picture				
Typ / type	6,3 x 32 632.500	UL 6,3 x 32 UL 632.500	6,3 x 32 632.600	6,3 x 32 632.000
Merkmal / characteristic	F	F	F	F
Strom / current	100 mA – 16 A	100 mA – 10 A	32 mA – 16 A	80 mA – 16 A
Spannung / voltage	500 V	250 V	250 V / 150 V / 60 V	250 V
Ausschaltvermögen / breaking capacity	1.000 A	35 A / 100 A / 200 A	35 A – 100 A	1.000 A
Prüfzeichen / approvals				
Norm	Werknorm	UL No. 248-14	DIN 41668 EN 60127-2-4	Werknorm
Katalogseite / catalogue page	34	35	36	37

Bemessungswerte/ Ratings	G - Sicherungseinsätze / Fuse - links			
Produktfoto / product picture				
Typ / type	UL 6,3 x 32 UL 632.600	6,3 x 32 632.200	6,3 x 32 632.300	UL 6,3 x 32 UL 632.300
Merkmal / characteristic	F	M	T	T
Strom / current	100 mA – 15 A	32 mA – 16 A	32 mA – 16 A	63 mA – 15 A
Spannung / voltage	125 V / 250 V	250 V	250 V	125 V / 250 V
Ausschaltvermögen / breaking capacity	200 A / 10.000 A	35 A / 1.000 A	35 A / 1.000 A	200 A / 10.000 A
Prüfzeichen / approvals				
Norm	UL No. 248-14	Werknorm	IEC 60127	UL No. 248-14
Katalogseite / catalogue page	38	39	40	41

Bemessungswerte/ Ratings	G - Sicherungseinsätze / Fuse - links			
Produktfoto / product picture				
Typ / type	6,3 x 32 632.700	UL 6,3 x 32 UL 632.700	6,3 x 32 632.900	8 x 40 556.00
Merkmal / characteristic	T	T	T	auf Anfrage/ on request
Strom / current	100 mA – 10 A	63 mA – 15 A	50 mA – 2 A	32 mA – 10 A
Spannung / voltage	500 V	125 / 250 V	500 V	500 V
Ausschaltvermögen / breaking capacity	1.000 A	720 A / 10.000 A	35 A	auf Anfrage/ on request
Prüfzeichen / approvals				
Norm	Werknorm	UL No. 248-14	Werknorm	DIN 41686
Katalogseite / catalogue page	42	43	44	45

Bemessungswerte/ Ratings	G - Sicherungseinsätze / Fuse - links			
Produktfoto / product picture				
Typ / type	8 x 50 557.000	8 x 85 558.00	8 x 120 559.000	8 x 150 560.000
Merkmal / characteristic	auf Anfrage/ on request	auf Anfrage/ on request	auf Anfrage/ on request	auf Anfrage/ on request
Strom / current	32 mA – 6,3 A	32 mA – 4 A	32 A – 8 A	32 mA – 2 A
Spannung / voltage	1,2 kV	3 kV	6 kV	10 kV
Ausschaltvermögen / breaking capacity	auf Anfrage/ on request	auf Anfrage/ on request	auf Anfrage/ on request	auf Anfrage/ on request
Prüfzeichen / approvals				
Norm	DIN 41570	DIN 41569	DIN 41683	DIN 41684
Katalogseite / catalogue page	45	46	46	46

Bemessungswerte/ Ratings	G - Sicherungseinsätze / Fuse - links		
Produktfoto / product picture			
Typ / type	10,3 x 38 1038.100	10,3 x 38 1038.600	10,3 x 38 1038.300
Merkmal / characteristic	FF	F	T
Strom / current	1,25 A – 32 A	0,5 A – 32 A	0,5 A – 32 A
Spannung / voltage	660 V	500 V	500 V
Ausschaltvermögen / breaking capacity	160 kA	120 kA	120 kA
Prüfzeichen / approvals			
Norm	IEC 60269/1-4	IEC 60269-1 IEC 60269-2 IEC 60269-2-1	IEC 60269-1 IEC 60269-2 IEC 60269-2-1
Katalogseite / catalogue page	47	48	49

**Aufbau:**

Glasrohr, durchsichtig

500mA, 5A Glasrohr mit Löschmittel

Kontaktkappen:

Messing, vernickelt

Lötbarkeit: gemäß EN 60068-2-20**Verpackungsmöglichkeiten:**

100 St. = 10 x 10er Faltschachteln

1000 St. = Industrieverpackung (lose geschüttet in Faltkarton)

Als Baugruppe mit 2 Aufsteckkappen in beliebiger Form und Länge, fertig montiert

Construction:

Glasstube, transparent

500mA, 5A Glasstube with extinguishing agent

Contact caps:

Brass, nickel plated

Solderability: by EN 60068-2-20**Packing options:**

100 pcs. = 10 boxes of 10 pieces

1000 pcs. = Industrial box (loose in carton)

As assembly with two pigtailed in various forms and lengths, finally mounted

Bemessungswerte / Ratings

Art.-No.	Strom Current	Spannung Voltage	Ausschaltvermögen Breaking capacity	Spannungsfall Voltage drop max [mV]	Max. Verlustleistung Max. power dissipation [W]
515.607	100 mA	250 V	35 A		
515.608	125 mA	250 V	35 A		
515.609	160 mA	250 V	35 A		
515.610	200 mA	250 V	35 A		
515.611	250 mA	250 V	35 A		
515.612	315 mA	250 V	35 A		
515.613	400 mA	250 V	35 A		
515.614	500 mA	250 V	35 A		
515.615	630 mA	250 V	35 A		
515.616	800 mA	250 V	35 A		
515.617	1 A	250 V	35 A	auf Anfrage/ on request	auf Anfrage/ on request
515.618	1,25 A	250 V	100 A		
515.619	1,6 A	250 V	100 A		
515.620	2 A	250 V	100 A		
515.621	2,5 A	250 V	100 A		
515.622	3,15 A	250 V	100 A		
515.623	4 A	125 V	400 A		
515.624	5 A	125 V	400 A		
515.625	6,3 A	125 V	400 A		

Schmelzzeit-Grenzwert / Pre-arcing time limits

Bemessungsstrom Rated current	2,1 I _{rat} max.	min. 2,75 I _{rat} max.	min. 4 I _{rat} max.	10 I _{rat} max.
100 mA – 6,3 A	120 s	9 ms	750ms	2 ms 250 ms

**Aufbau:**

Glasrohr, durchsichtig

Kontaktkappen:

Messing, vernickelt

Lötbarkeit: gemäß EN 60068-2-20**Verpackungsmöglichkeiten:**

100 St. = 10 x 10er Faltschachteln

1000 St. = Industrieverpackung (lose geschüttet in Faltkarton)

Als Baugruppe mit 2 Aufsteckkappen in beliebiger Form und Länge, fertig montiert

Construction:

Glasstube, transparent

Contact caps:

Brass, nickel plated

Solderability: by EN 60068-2-20**Packing options:**

100 pcs. = 10 boxes of 10 pieces

1000 pcs. = Industrial box (loose in carton)

As assembly with two pigtailed in various forms and lengths, finally mounted

Bemessungswerte / Ratings

Art.-No.	Strom Current	Spannung Voltage	Ausschaltvermögen Breaking capacity	Spannungsfall Voltage drop max [mV]	Max. Verlustleistung Max. power dissipation [W]
515.311	250 mA	250 V	35 A		
515.312	315 mA	250 V	35 A		
515.313	400 mA	250 V	35 A		
515.314	500 mA	250 V	35 A		
515.315	630 mA	250 V	35 A		
515.316	800 mA	250 V	35 A	auf Anfrage / on request	auf Anfrage / on request
515.317	1 A	250 V	35 A		
515.318	1,25 A	250 V	100 A		
515.359	1,5 A	250 V	100 A		
515.319	1,6 A	250 V	100 A		
515.320	2 A	250 V	100 A		
515.321	2,5 A	250 V	100 A		
515.322	3,15 A	250 V	100 A		
515.365	3,5 A	250 V	400 A		
515.323	4 A	125 V	400 A		
515.324	5 A	125 V	400 A		
515.366	6 A	125 V	400 A		
515.325	6,3 A	125 V	400 A		

Schmelzzeit-Grenzwert / Pre-arcing time limits

Bemessungsstrom Rated current	2,1 I _{rat}		2,75 I _{rat}		4 I _{rat}		10 I _{rat}	
	min.	max.	min.	max.	min.	max.	min.	max.
250 mA – 6,3 A		120 s	0,4 s	10 s	150 ms	3 s	20 ms	300 ms

**Aufbau:**

100 mA-1,25 A Glasrohr, durchsichtig
1,6-12,5 A Keramikrohr mit Löschmittel

Kontaktkappen:

Messing, vernickelt

Lötbarkeit: gemäß EN 60068-2-20

Verpackungsmöglichkeiten:

100 St. = 10 x 10er Faltschachteln

1000 St. = Industrieverpackung (lose geschüttet
in Faltkarton)

Als Baugruppe mit 2 Aufsteckkappen in
beliebiger Form und Länge, fertig montiert

Construction:

100 mA-1,25 A Glasstube, transparent

1,6-12,5 A ceramic-tube with extinguishing agent

Contact caps:

Brass, nickel plated

Solderability: by EN 60068-2-20

Packing options:

100 pcs. = 10 boxes of 10 pieces

1000 pcs. = Industrial box (loose in carton)

As assembly with two pigtails in various forms
and lengths, finally mounted

Bemessungswerte / Ratings

Art.- No.	Strom Current	Spannung Voltage	Ausschaltvermögen Breaking capacity	Spannungsfall Voltage drop max [mV]	Schmelzintegral Melting integral [A ² s]
520.107	100 mA	250 V	35 A	3500	0,0020
520.108	125 mA	250 V	35 A	3000	0,0031
520.109	160 mA	250 V	35 A	3000	0,0051
520.110	200 mA	250 V	35 A	2500	0,0104
520.111	250 mA	250 V	35 A	2500	0,028
520.112	315 mA	250 V	35 A	2000	0,059
520.113	400 mA	250 V	35 A	1500	0,096
520.114	500 mA	250 V	35 A	1500	0,17
520.115	630 mA	250 V	35 A	750	0,18
520.116	800 mA	250 V	35 A	750	0,38
520.117	1 A	250 V	35 A	250	0,52
520.118	1,25 A	250 V	35 A	250	1,25
520.119	1,6 A	250 V	1500 A	1000	0,26
520.120	2 A	250 V	1500 A	700	0,40
520.121	2,5 A	250 V	1500 A	700	0,63
520.122	3,15 A	250 V	1500 A	600	0,99
520.123	4 A	250 V	1500 A	600	6,40
520.124	5 A	250 V	1500 A	500	7,50
520.125	6,3 A	250 V	1500 A	500	11,91
520.126	8 A	250 V	1500 A	400	56,32
520.127	10 A	250 V	1500 A	400	40,00
520.128	12,5 A	250 V	1500 A	300	46,88

Schmelzzeit-Grenzwert / Pre-arcing time limits

Bemessungsstrom Rated current	1,0 I _{rat} min.	1,5 I _{rat} max.	2,75 I _{rat} min. max.	4 I _{rat} min. max.	10 I _{rat} max.
100 mA - 12,5 A	1 h	30 min.	2 ms 150ms	1 ms 50ms	10 ms

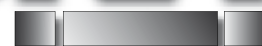

Aufbau:

50 mA – 500mA: Keramikrohr
630 mA – 10 A: Keramikrohr, mit Löschmittel

Kontaktkappen:

Messing, vernickelt

Lötbarkeit: gemäß EN 60068-2-20

Verpackungsmöglichkeiten:

100 St. = 10 x 10er Faltschachteln
1000 St. = Industrieverpackung (lose geschüttet in Faltkarton)

Als Baugruppe mit 2 Aufsteckkappen in beliebiger Form und Länge, fertig montiert

Construction:

50 mA – 500 mA: Ceramictube
630 mA – 10 A Ceramictube, with extinguishing agent

Contact caps:

Brass, nickel plated

Solderability: by EN 60068-2-20

Packing options:

100 pcs. = 10 boxes of 10 pieces
1000 pcs. = Industrial box (loose in carton)
As assembly with two pigtailed in various forms and lengths, finally mounted

Bemessungswerte / Ratings

Art.-No.	Strom Current	Spannung Voltage	Ausschaltvermögen Breaking capacity	Spannungsfall Voltage drop max [mV]	Verlustleistung power dissip. max[W]	Schmelzintegral Melting integral [A ² s]
520.504 ²⁾	50 mA	250 V	1500 A	10.000	1,6	0,00065
520.505 ²⁾	63 mA	250 V	1500 A	8.800	1,6	0,00090
520.506 ²⁾	80 mA	250 V	1500 A	7.600	1,6	0,0015
520.507 ²⁾	100 mA	250 V	1500 A	7.000	1,6	0,0040
520.508 ²⁾	125 mA	250 V	1500 A	5.000	1,6	0,0081
520.509 ²⁾	160 mA	250 V	1500 A	4.300	1,6	0,015
520.510 ²⁾	200 mA	250 V	1500 A	3.500	1,6	0,023
520.511 ²⁾	250 mA	250 V	1500 A	2.800	2,5	0,055
520.512 ²⁾	315 mA	250 V	1500 A	2.500	2,5	0,14
520.513 ²⁾	400 mA	250 V	1500 A	2.000	2,5	0,21
520.514 ²⁾	500 mA	250 V	1500 A	1.800	2,5	0,18
520.515 ²⁾	630 mA	250 V	1500 A	1.500	2,5	0,12
520.516 ²⁾	800 mA	250 V	1500 A	1.200	2,5	0,13
520.517 ²⁾	1 A	250 V	1500 A	1.000	2,5	0,16
520.518	1,25 A	250 V	1500 A	800	4	0,63
520.519	1,6 A	250 V	1500 A	600	4	0,77
520.520	2 A	250 V	1500 A	500	4	1,44
520.521	2,5 A	250 V	1500 A	400	4	3,13
520.522	3,15 A	250 V	1500 A	350	4	13,30
520.523	4 A	250 V	1500 A	300	4	16,00
520.524	5 A	250 V	1500 A	250	4	31,00
520.525	6,3 A	250 V	1500 A	200	4	79,38
520.526	8 A	250 V	1500 A	200	4	89,60
520.527	10 A	250 V	1500 A	200	4	250,00

Schmelzeit-Grenzwert / Pre-arcing time limits

Bemessungsstrom Rated current	2,1 I _{rat} max.	2,75 I _{rat}		4 I _{rat}		10 I _{rat} max.
		min.	max.	min.	max.	
0,05A – 3,15 A	30 min	10 ms	2 s	3 ms	300 ms	20 ms
4A – 6,3A	30 min	10 ms	3 s	3 ms	300 ms	20 ms
8 A + 10 A	30 min	40 ms	20 s	10 ms	1 s	30 ms

2) kein Semko / no Semko approval



Aufbau:

Glasrohr, durchsichtig

Kontaktkappen:

Messing, vernickelt

Lötbarkeit: gemäß EN 60068-2-20

Verpackungsmöglichkeiten:

100 St. = 10 x 10er Faltschachteln

1000 St. = Industrieverpackung (lose geschüttet in Faltkarton)

Als Baugruppe mit 2 Aufsteckkappen in beliebiger Form und Länge, fertig montiert

Construction:

Glasstube, transparent

Contact caps:

Brass, nickel plated

Solderability: by EN 60068-2-20

Packing options:

100 pcs. = 10 boxes of 10 pieces

1000 pcs. = Industrial box (loose in carton)

As assembly with two pigtailed in various forms and lengths, finally mounted

Bemessungswerte / Ratings

Art.-No.	Strom Current	Spannung Voltage	Ausschaltvermögen Breaking capacity	Spannungsfall Voltage drop max [mV]	Verlustleistung power dissip. max [W]	Schmelzintegral Melting integral [A ² s]
520.602	32 mA	250 V	35 A	10.000	1,6	0,00096
520.603	40 mA	250 V	35 A	8.000	1,6	0,00032
520.604	50 mA	250 V	35 A	7.000	1,6	0,00065
520.605	63 mA	250 V	35 A	5.000	1,6	0,00080
520.606	80 mA	250 V	35 A	4.000	1,6	0,0014
520.607	100 mA	250 V	35 A	3.500	1,6	0,0040
520.608	125 mA	250 V	35 A	2.000	1,6	0,0078
520.609	160 mA	250 V	35 A	2.000	1,6	0,014
520.610	200 mA	250 V	35 A	1.700	1,6	0,028
520.611	250 mA	250 V	35 A	1.400	1,6	0,063
520.612	315 mA	250 V	35 A	1.300	1,6	0,14
520.613	400 mA	250 V	35 A	1.200	1,6	0,26
520.614	500 mA	250 V	35 A	1.000	1,6	0,20
520.615	630 mA	250 V	35 A	650	1,6	0,47
520.616	800 mA	250 V	35 A	240	1,6	0,58
520.617	1 A	250 V	35 A	200	1,6	1,42
520.618	1,25 A	250 V	35 A	200	1,6	2,03
520.619	1,6 A	250 V	35 A	190	1,6	3,99
520.620	2 A	250 V	35 A	170	1,6	6,08
520.621	2,5 A	250 V	35 A	170	1,6	11,25
520.622	3,15 A	250 V	35 A	150	2,5	18,65
520.623	4 A	250 V	40 A	130	2,5	40,00
520.624	5 A	250 V	50 A	130	2,5	29,00
520.625	6,3 A	250 V	63 A	130	2,5	107,16
520.626	8 A	125 V	80 A	130	4	220,16
520.627	10 A	125 V	100 A	130	4	306,00

Schmelzeit-Grenzwert / Pre-arcing time limits

Bemessungsstrom Rated current	2,1 I _{rat}	2,75 I _{rat}		4 I _{rat}		10 I _{rat}
	max.	min.	max.	min.	max.	max.
32 mA – 100 mA	30 min	10 ms	500 ms	3 ms	100 ms	20 ms
125 mA – 6,3 A	30 min	50 ms	2 s	10 ms	300 ms	20 ms
8A – 10 A	30 min	50 ms	2 s	10 ms	400 ms	40 ms



Aufbau:

Glasrohr, mit Löschmittel

Kontaktkappen:

Messing, vernickelt

Lötbarkeit: gemäß EN 60068-2-20

Verpackungsmöglichkeiten:

100 St. = 10 x 10er Faltschachteln

1000 St. = Industrieverpackung (lose geschüttet in Faltkarton)

Als Baugruppe mit 2 Aufsteckkappen in beliebiger Form und Länge, fertig montiert

Construction:

Glasstube, with extinguishing agent

Contact caps:

Brass, nickel plated

Solderability: by EN 60068-2-20

Packing options:

100 pcs. = 10 boxes of 10 pieces

1000 pcs. = Industrial box (loose in carton)

As assembly with two pigtailed in various forms and lengths, finally mounted

Bemessungswerte / Ratings

Art.-No.	Strom Current	Spannung Voltage	Ausschaltvermögen Breaking capacity	Spannungsfall Voltage drop max [mV]	Schmelzintegral Melting integral [A ² s]
520.019	1,6 A	250 V		480	1,28
520.020	2 A	250 V	250 A / 250 V -	400	0,80
520.021	2,5 A	250 V	1000 A / 250 V ~	400	2,12
520.022	3,15 A	250 V		240	7,54
520.023	4 A	250 V		240	19,84
520.024	5A	250 V		230	20,00
520.025	6,3A	250 V		170	67,47
520.026 ¹⁾	8 A	250 V	300 A / 250 V~	160	126,72
520.027 ¹⁾	10 A	250 V	300 A / 250 V~	150	244,00
520.028 ¹⁾	12,5 A	250 V	300 A / 250 V~	150	496,87
520.030 ¹⁾	16 A	250 V	300 A / 250 V~	130	855,04

Schmelzzeit-Grenzwert / Pre-arcing time limits

Bemessungsstrom Rated current	1,5 Irat min.	2,1 Irat max.	4 Irat max.	10 Irat max.
1,6 - 6,3 A	1 h	30 min.	300 ms	20 ms

1) Nicht in der Normreihe verzeichnet / Not mentioned in the standards



Aufbau:

Glasrohr, durchsichtig

Kontaktkappen:

Messing, vernickelt

Verpackungsmöglichkeiten:

100 St. = 10 x 10er Faltschachteln

1000 St. = Industrieverpackung (lose geschüttet in Faltkarton)

Als Baugruppe mit 2 Aufsteckkappen in beliebiger Form und Länge, fertig montiert

Construction:

Glasstube, transparent

Contact caps:

Brass, nickel plated

Packing options:

100 pcs. = 10 boxes of 10 pieces

1000 pcs. = Industrial box (lose in carton)

As assembly with two pigtails in various forms and lengths, finally mounted

Bemessungswerte / Ratings

Art.-No.	Strom Current (A)	Spannung Voltage	Ausschaltvermögen Breaking capacity	Spannungsfall Voltage drop [mV] max.	Max. Leistungsverlust Max. power dissipation [W]	Schmelzintegral Melting integral [A ² S]
UL 520.606	80 mA	250 V	200 A	3050	0,32	0,0004
UL 520.607	100 mA	250 V	200 A	2650	0,35	0,0009
UL 520.608	125 mA	250 V	200 A	3640	0,60	0,0017
UL 520.610	200 mA	250 V	200 A	2760	0,72	0,007
UL 520.611	250 mA	250 V	200 A	1190	0,25	0,016
UL 520.650	300 mA	250 V	200 A	1120	0,39	0,020
UL 520.612	350 mA	250 V	200 A	1020	0,36	0,038
UL 520.613	400 mA	250 V	200 A	934	0,20	0,080
UL 520.614	500 mA	250 V	200 A	791	0,33	0,122
UL 520.615	600 mA	250 V	200 A	719	0,44	0,195
UL 520.655	700 mA	250 V	200 A	684	0,65	0,265
UL 520.616	800 mA	250 V	200 A	634	0,54	0,398
UL 520.617	1 A	250 V	200 A	201	0,26	0,877
UL 520.618	1,25 A	250 V	200 A	189	0,31	1,5
UL 520.659	1,5 A	250 V	200 A	178	0,36	2,6
UL 520.620	2 A	250 V	200 A	167	0,44	4,4
UL 520.621	2,5 A	250 V	200 A	157	0,52	7,6
UL 520.663	3 A	250 V	200 A	148	0,59	13
UL 520.622	3,5 A	250 V	200 A	141	0,65	17
UL 520.623	4 A	125 V	10.000 A	137	0,72	22
UL 520.624	5 A	125 V	10.000 A	129	0,84	38
UL 520.625	6 A	125 V	10.000 A	121	0,96	65
UL 520.656	7 A	125 V	10.000 A	119	1,10	88
UL 520.626	8 A	125 V	10.000 A	117	1,23	113

Schmelzeit-Grenzwert / Pre- arcing time limits

Prüfstrom Testing current	Schmelzeit / Blow Time	
	Minimum	Maximum
100 %	4 Hrs	N / A
135 %	N / A	1 Hr
200 %	N / A	5 sec



Aufbau:

32 mA-1,25 A: Glasrohr, durchsichtig
1,6-16 A: Glasrohr, mit Löschmittel

Kontaktkappen: Messing, vernickelt

Lötbarkeit: gemäß EN 60068-2-20

Verpackungsmöglichkeiten 100 St. = 10 x 10er Faltschachteln

1000 St. = Industrieverpackung (lose geschüttet in Faltkarton)

Als Baugruppe mit 2 Aufsteckkappen in beliebiger Form und Länge, fertig montiert

Construction:

32 mA-1,25 A: Glasstube, transparent

1,6-16 A: Glasstube, with extinguishing agent

Contact caps: Brass, nickel plated

Solderability: by EN 60068-2-20

Packing options: 100 pcs. = 10 boxes of 10 pieces

1000 pcs. = Industrial box (loose in carton)

As assembly with two pigtails in various form and lengths, finally mounted

Bemessungswerte / Ratings

Art.-No.	Strom Current	Spannung Voltage	Ausschaltvermögen Breaking capacity	Spannungsfall Voltage drop max [mV]	Schmelzintegral Melting integral [A ² s]
521.002	32 mA	250 V	80 A / 250 V	1400	0,00010
1.521.002	32 mA	250 V	80 A / 250 V	640	0,0087
521.003	40 mA	250 V	80 A / 250 V	1000	0,0095
521.004	50 mA	250 V	80 A / 250 V	600	0,00025
1.521.004	50 mA	250 V	80 A / 250 V	900	0,013
521.005	63 mA	250 V	80 A / 250 V	560	0,00040
1.521.005	63 mA	250 V	80 A / 250 V	560	0,024
521.006	80 mA	250 V	80 A / 250 V	520	0,040
521.007	100 mA	250 V	80 A / 250 V	470	0,007
521.008	125 mA	250 V	80 A / 250 V	420	0,019
521.009	160 mA	250 V	80 A / 250 V	370	0,041
521.010	200 mA	250 V	80 A / 250 V	320	0,082
521.011	250 mA	250 V	80 A / 250 V	280	0,19
521.012	315 mA	250 V	80 A / 250 V	250	0,29
521.013	400 mA	250 V	80 A / 250 V	230	0,72
521.014	500 mA	250 V	80 A / 250 V	210	0,18
521.015	630 mA	250 V	80 A / 250 V	190	0,44
521.016	800 mA	250 V	80 A / 250 V	170	0,82
521.017	1 A	250 V	80 A / 250 V	160	6,02
521.018	1,25 A	250 V	80 A / 250 V	160	2,81
521.019	1,6 A	250 V	1000 A / 250 V	160	7,07
521.020	2 A	250 V	1000 A / 250 V	160	12,40
521.021	2,5 A	250 V	1000 A / 250 V	160	4,38
521.022	3,15 A	250 V	1000 A / 250 V	160	52,39
521.023	4 A	250 V	1000 A / 250 V	160	44,48
521.024	5 A	250 V	1000 A / 250 V	150	33,50
521.025	6,3 A	250 V	1000 A / 250 V	140	64,30
521.026	8 A	250 V	300 A / 250 V	140	142,08
521.027	10 A	250 V	300 A / 250 V	120	294,00
521.028 ¹⁾	12,5 A	250 V	300 A / 250 V	120	428,12
521.030 ¹⁾	16 A	250 V	300 A / 250 V	120	721,92
521.031 ¹⁾	20 A	250 V	300 A / 250 V	120	2176,00

Schmelzzeit-Grenzwert / Pre-arcing time limits

Bemessungsstrom Rated current	1,5 I _{rat}		2,1 I _{rat}		4 I _{rat}		10 I _{rat}	
	min.	max.	min.	max.	min.	max.	min.	max.
32 mA – 1,25 A	1 h	10 min.	40 ms	2000 ms	5 ms	90 ms		
1,6 A – 10 A	1 h	30 min.	40 ms	2000 ms	5 ms	90 ms		

1) Nicht in der Normreihe verzeichnet / Not mentioned in the standards



Aufbau:

Keramikrohr, mit Löschmittel

Kontaktkappen:

Messing, vernickelt

Lötbarkeit: gemäß EN 60068-2-20

Verpackungsmöglichkeiten:

100 St. = 10 x 10er Faltschachteln

1000 St. = Industrieverpackung (lose geschüttet in Faltkarton)

Als Baugruppe mit 2 Aufsteckkappen in beliebiger Form und Länge, fertig montiert

Construction:

Ceramic tube, with extinguishing agent

Contact caps:

Brass, nickel plated

Solderability: by EN 60068-2-20

Packing options:

100 pcs. = 10 boxes of 10 pieces

1000 pcs. = Industrial box (loose in carton)

As assembly with two pigtails in various forms and lengths, finally mounted

Bemessungswerte / Ratings

Art.-No.	Strom Current	Spannung Voltage	Ausschaltvermögen Breaking capacity	Spannungsfall Voltage drop max [mV]	Schmelzintegral Melting integral [A ² s]
521.519	1,6 A	250 V	1500 A		1,23
521.520	2 A	250 V	1500 A		1,28
521.521	2,5 A	250 V	1500 A		4,88
521.522	3,15 A	250 V	1500 A		6,75
521.523	4 A	250 V	1500 A	auf Anfrage /	16,96
521.524	5 A	250 V	1500 A	on request	40,00
521.525	6,3 A	250 V	1500 A		97,64
521.526	8 A	250 V	1500 A		533,76
521.527	10 A	250 V	1500 A		290,00
521.528	12,5 A	250 V	1500 A		428,12
521.530	16 A	250 V	1500 A		762,88

Schmelzzeit-Grenzwert / Pre-arcing time limits

Bemessungsstrom Rated current	1,5 I _{rat} min.	2,1 I _{rat} max.	min.	4 I _{rat} max.	min.	10 I _{rat} max.
1,6 A – 16 A	1 h	30 min.	40ms	2000 ms	3 ms	90 ms

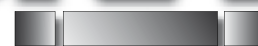

Aufbau:

Glasrohr, durchsichtig

Kontaktkappen:

Messing, vernickelt

Verpackungsmöglichkeiten:

100 St. = 10 x 10er Faltschachteln

500 St. / 1000 St. = Industrieverpackung (lose geschüttet in Faltkarton)

Als Baugruppe mit 2 Aufsteckkappen in beliebiger Form und Länge, fertig montiert

Construction:

Glasstube, transparent

Contact caps:

Brass, nickel plated

Packing opinions:

100 pcs. = 10 boxes of 10 pieces

500 pcs. / 1000 pcs. = Industrial box (loose in carton). As assembly with two pigtailed in various forms and lengths, finally mounted

Bemessungswerte / Ratings

Art.-No.	Strom Current (A)	Spannung Voltage	Ausschaltvermögen Breaking capacity	Spannungsfall Voltage drop [mV] max.	Max. Verlustleistung Max. power dissipation [W]	Schmelzintegral Melting integral [A ² S]
UL 521.007	100 mA	250 V	35 A	1700	0,30	0,02
UL 521.008	125 mA	250 V	35 A	1400	0,32	0,04
UL 521.009	160 mA	250 V	35 A	1200	0,34	0,06
UL 521.010	200 mA	250 V	35 A	1000	0,36	0,11
UL 521.011	250 mA	250 V	35 A	872	0,38	0,18
UL 521.012	300 mA	250 V	35 A	738	0,37	0,31
UL 521.034	375 mA	250 V	35 A	649	0,40	0,47
UL 521.014	500 mA	250 V	35 A	529	0,43	0,88
UL 521.015	600 mA	250 V	35 A	448	0,45	1,5
UL 521.016	700 mA	250 V	35 A	400	0,48	2,2
UL 521.035	750 mA	250 V	35 A	392	0,49	2,3
UI 521.016	800 mA	250 V	35 A	320	0,49	3,8
UL 521.017	1 A	250 V	100 A	321	0,49	4,2
UL 521.018	1,25 A	250 V	100 A	272	0,52	7,2
UL 521.019	1,6 A	250 V	100 A	230	0,55	12
UL 521.020	2 A	250 V	100 A	195	0,59	20
UL 521.021	2,5 A	250 V	100 A	183	0,65	35
UL 521.060	3 A	250 V	100 A	172	0,74	58
UL 521.022	3,5 A	125 V	10.000 A	167	0,84	76
UL 521.023	4 A	125 V	10.000 A	162	0,91	99
UL 521.024	5 A	125 V	10.000 A	152	1,1	167
UL 521.025	6 A	125 V	10.000 A	148	1,3	315
UL 521.026	7 A	125 V	10.000 A	125	2,1	750

Schmelzeit-Grenzwert / Pre- arcing time limits

Prüfstrom Testing current	Schmelzeit / Blow Time	
	Minimum	Maximum
100 %	4 Hrs	N / A
135 %	N / A	1 Hr
200 %	N / A	15 sec
1000 %	10 ms	N / A

**Aufbau:**

100 mA – 500mA: Keramikrohr

630 mA – 10 A: Keramikrohr, mit Löschmittel

Kontaktkappen:

Messing, vernickelt

Lötbarkeit: gemäß EN 60068-2-20**Verpackungsmöglichkeiten:**

100 St. = 10 x 10er Faltschachteln

1000 St. = Industrieverpackung (lose geschüttet in Faltkarton)

Als Baugruppe mit 2 Aufsteckkappen in beliebiger Form und Länge, fertig montiert

Construction:

100 mA – 500 mA: Ceramictube

630 mA – 10 A Ceramictube, with extinguishing agent

Contact caps:

Brass, nickel plated

Solderability: by EN 60068-2-20**Packing options:**

100 pcs. = 10 boxes of 10 pieces

1000 pcs. = Industrial box (loose in carton)

As assembly with two pigtails in various forms and lengths, finally mounted

Bemessungswerte / Ratings

Art.-No.	Strom Current	Spannung Voltage	Ausschaltvermögen Breaking capacity	Spannungsfall Voltage drop max [mV]	Verlustleistung Sustained dissip. max [W]	Schmelzintegral Melting integral [A ² s]
522.707	100 mA	250 V	1500 A	2.800	1,6	0,045
522.708	125 mA	250 V	1500 A	2.600	1,6	0,050
522.709	160 mA	250 V	1500 A	2.400	1,6	0,11
522.710	200 mA	250 V	1500 A	2.100	1,6	0,11
522.711	250 mA	250 V	1500 A	1.500	1,6	0,51
522.712	315 mA	250 V	1500 A	1.100	1,6	0,59
522.713	400 mA	250 V	1500 A	1.000	1,6	0,54
522.714	500 mA	250 V	1500 A	850	1,6	1,73
522.715	630 mA	250 V	1500 A	650	1,6	0,34
522.716	800 mA	250 V	1500 A	500	1,6	0,79
522.717	1 A	250 V	1500 A	350	2,5	1,52
522.718	1,25 A	250 V	1500 A	300	2,5	2,44
522.719	1,6 A	250 V	1500 A	200	2,5	5,73
522.720	2 A	250 V	1500 A	190	2,5	10,40
522.721	2,5 A	250 V	1500 A	180	2,5	23,00
522.722 ¹⁾²⁾	3,15 A	250 V	1500 A	140	4,0	50,60
522.723 ¹⁾²⁾	4 A	250 V	1500 A	100	4,0	43,84
522.724 ¹⁾²⁾	5 A	250 V	1500 A	100	4,0	83,50
522.725	6,3 A	250 V	1500 A	100	4,0	147,65
522.726 ¹⁾²⁾	8 A	250 V	1500 A	100	4,0	544,00
522.727 ¹⁾²⁾	10 A	250 V	1500 A	100	4,0	632,00

Schmelzzeit-Grenzwert / Pre-arcing time limits

Bemessungsstrom Rated current	2,1 I _{rat} max.		2,75 I _{rat} min. max.		4 I _{rat} min. max.		10 I _{rat} min. max.	
	100 mA – 800 mA	30 min	250 ms	80 s	50 ms	5 s	5 ms	150 ms
1 A – 3,15 A	30 min	750 ms	80 s	95 ms	5 s	10 ms	150 ms	
4 A – 10 A	30 min	750 ms	80 s	150 ms	5 s	20 ms	150 ms	

1) kein VDE / no VDE approval

2) kein Semko / no Semko approval



Aufbau:

Glasrohr, durchsichtig

Kontaktkappen:

Messing, vernickelt

Verpackungsmöglichkeiten:

100 St. = 10 x 10er Faltschachteln

500 St. / 1000 St. = Industrieverpackung (lose geschüttet in Faltkarton)

Als Baugruppe mit 2 Aufsteckkappen in beliebiger Form und Länge, fertig montiert

Construction:

Glasstube, transparent

Contact caps:

Brass, nickel plated

Packing options:

100 pcs. = 10 boxes of 10 pieces

500 pcs. / 1000 pcs. = Industrial box (loose in carton) As assembly with two pigtails in various forms and lengths, finally mounted

Bemessungswerte / Ratings

Art.-No.	Strom Current (A)	Spannung Voltage	Ausschaltvermögen Breaking capacity	Spannungsfall Voltage drop (Volt) max.	Max. Verlustleistung Max. power dissipation [W]	Schmelzintegral Melting integral [A ² S]
UL 522.206	80 mA	250 V	100 A	3,10	0,422	0,091
UL 522.207	100 mA	250 V	100 A	2,77	0,45	0,137
UL 522.208	125 mA	250 V	100 A	2,34	0,48	0,208
UL 522.209	160 mA	250 V	100 A	1,98	0,51	0,314
UL 522.210	200 mA	250 V	100 A	1,68	0,55	0,476
UL 522.211	250 mA	250 V	100 A	1,42	0,58	0,719
UL 522.250	300 mA	250 V	100 A	1,20	0,60	0,885
UL 522.213	400 mA	250 V	100 A	1,02	0,66	1,65
UL 522.214	500 mA	250 V	100 A	0,86	0,70	2,49
UL 522.215	600 mA	250 V	100 A	0,75	0,75	3,77
UL 522.216	700 mA	250 V	100 A	0,68	0,78	4,64
UL 522.255	750 mA	250 V	100 A	0,64	0,79	5,25
UL 522.217	1 A	250 V	100 A	0,52	0,85	8,63
UL 522.218	1,25 A	250 V	100 A	0,44	0,91	13,1
UL 522.251	1,5 A	250 V	100 A	0,39	0,96	18,3
UL 522.219	1,6 A	250 V	100 A	0,37	0,97	19,7
UL 522.220	2 A	250 V	100 A	0,32	1,03	29,9
UL 522.221	2,5 A	250 V	100 A	0,27	1,10	45,2
UL 522.263	3 A	250 V	100 A	0,23	1,13	55,6
UL 522.222	3,15 A	125 V	100 A	0,22	1,17	68,4
UL 522.223	4 A	125 V	10.000 A	0,19	1,25	103
UL 522.224	5 A	125 V	10.000 A	0,16	1,33	157
UL 522.225	6 A	125 V	10.000 A	0,12	1,23	218
UL 522.226	8 A	125 V	10.000 A	0,11	1,31	319
UL 522.227	10 A	125 V	1.000 A	0,086	1,40	467

Schmelzeit-Grenzwert / Pre- arcing time limits

Prüfstrom Testina current	Schmelzeit / Blow Time		Amp range
	Minimum	Maximum	
100 %	4 Hrs.	N / A	50 mA – 10 A
135 %	N / A	1 Hr	50 mA – 10 A
200 %	N / A	30 s	50 mA – 3 A
200 %	3 s	30 s	3,1 A -10 A



Aufbau:

Glasrohr, durchsichtig

Kontaktkappen:

Messing, vernickelt

Lötbarkeit: gemäß EN 60068-2-20

Verpackungsmöglichkeiten:

100 St. = 10 x 10er Faltschachteln

1000 St. = Industrieverpackung (lose geschüttet in Faltkarton)

Als Baugruppe mit 2 Aufsteckkappen in beliebiger Form und Länge, fertig montiert

Construction:

Glasstube, transparent

Contact caps:

Brass, nickel plated

Solderability: by EN 60068-2-20

Packing options:

100 pcs. = 10 boxes of 10 pieces

1000 pcs. = Industrial box (loose in carton)

As assembly with two pigtails in various forms and lengths, finally mounted

Bemessungswerte / Ratings

Art.-No.	Strom Current	Spannung Voltage	Ausschaltvermögen Breaking capacity	Spannungsfall Voltage drop max [mV]	Verlustleistung power dissip. max [W]	Schmelzintegral Melting integral [A ² s]
522.502 ²⁾	32 mA	250 V	35 A	5.000	1,6	0,022
522.503 ²⁾	40 mA	250 V	35 A	4.000	1,6	0,015
522.504 ²⁾	50 mA	250 V	35 A	3.500	1,6	0,0025
522.505 ²⁾	63 mA	250 V	35 A	3.000	1,6	0,029
522.506	80 mA	250 V	35 A	3.000	1,6	0,026
522.507	100 mA	250 V	35 A	2.500	1,6	0,051
522.508	125 mA	250 V	35 A	2.000	1,6	0,06
522.509	160 mA	250 V	35 A	1.900	1,6	0,10
522.510	200 mA	250 V	35 A	1.500	1,6	0,11
522.511	250 mA	250 V	35 A	1.300	1,6	0,49
522.512	315 mA	250 V	35 A	1.100	1,6	0,32
522.513	400 mA	250 V	35 A	1.000	1,6	0,51
522.514	500 mA	250 V	35 A	900	1,6	0,93
522.515	630 mA	250 V	35 A	300	1,6	1,59
522.516	800 mA	250 V	35 A	250	1,6	3,39
522.517	1 A	250 V	35 A	150	1,6	5,64
522.518	1,25 A	250 V	35 A	150	1,6	11,72
522.519	1,6 A	250 V	35 A	150	1,6	20,89
522.520	2 A	250 V	35 A	150	1,6	31,52
522.521	2,5 A	250 V	35 A	120	1,6	60,13
522.522	3,15 A	250 V	35 A	100	1,6	92,68
522.523	4 A	250 V	40 A	100	1,6	178,56
522.524	5 A	250 V	50 A	100	1,6	84,50
522.525	6,3 A	250 V	63 A	100	1,6	159,55
522.526	8 A	125 V / 250 V	80 A / 63 A	100	4	229,12
522.527	10 A	125 V / 250 V	100 A / 63 A	100	4	378,00

Schmelzzeit-Grenzwert / Pre-arcing time limits

Bemessungsstrom Rated current	2,1 I _{rat}		2,75 I _{rat}		4 I _{rat}		10 I _{rat}	
	max.	min.	max.	min.	max.	min.	max.	
32 mA – 100 mA 125 mA – 10 A	2 min 2 min	200 ms 600 ms	10 s 10 s	40 ms 150 ms	3 s 3 s	10 ms 20 ms	300 ms 300 ms	



Aufbau:

Glasrohr, durchsichtig

Kontaktkappen:

Messing, vernickelt

Lötbarkeit: gemäß EN 60068-2-20

Verpackungsmöglichkeiten:

100 St. = 10 x 10er Faltschachteln

1000 St. = Industrieverpackung (lose geschüttet in Faltkarton)

Als Baugruppe mit 2 Aufsteckkappen in beliebiger Form und Länge, fertig montiert

Construction:

Glasstube, transparent

Contact caps:

Brass, nickel plated

Solderability: by EN 60068-2-20

Packing options:

100 pcs. = 10 boxes of 10 pieces

1000 pcs. = Industrial box (loose in carton)

As assembly with two pigtails in various forms and lengths, finally mounted

Bemessungswerte / Ratings

Art.-No.	Strom Current	Spannung Voltage	Ausschaltvermögen Breaking capacity	Spannungsfall Voltage drop max [mV]	Verlustleistung power dissip. max [W]	Schmelzintegral Melting integral [A ² s]
522.302	32 mA	250 V	150 A	5.000	1,6	
522.303	40 mA	250 V	150 A	4.000	1,6	auf Anfrage / on request
522.304	50 mA	250 V	150 A	3.500	1,6	
522.305	63 mA	250 V	150 A	3.000	1,6	
522.306	80 mA	250 V	150 A	3.000	1,6	
522.307	100 mA	250 V	150 A	2.500	1,6	0,063
522.308	125 mA	250 V	150 A	2.000	1,6	0,050
522.309	160 mA	250 V	150 A	1.900	1,6	0,085
522.310	200 mA	250 V	150 A	1.500	1,6	0,11
522.311	250 mA	250 V	150 A	1.300	1,6	0,49
522.312	315 mA	250 V	150 A	1.100	1,6	0,33
522.313	400 mA	250 V	150 A	1.000	1,6	0,47
522.314	500 mA	250 V	150 A	900	1,6	0,83
522.315	630 mA	250 V	150 A	300	1,6	1,48
522.316	800 mA	250 V	150 A	250	1,6	3,29
522.317	1 A	250 V	150 A	150	1,6	5,80
522.318	1,25 A	250 V	150 A	150	1,6	11,88
522.319	1,6 A	250 V	150 A	150	1,6	21,25
522.320	2 A	250 V	150 A	150	1,6	35,52
522.321	2,5 A	250 V	150 A	120	1,6	59,75
522.322	3,15 A	250 V	150 A	100	1,6	90,69
522.323	4 A	250 V	150 A	100	1,6	166,40
522.324	5 A	250 V	150 A	100	1,6	88,00
522.325	6,3 A	250 V	150 A	100	1,6	138,92
522.326	8 A	250 V	150 A	100	4	
522.327	10 A	250 V	150 A	100	4	390,00

Schmelzzeit-Grenzwert / Pre-arcing time limits

Bemessungsstrom Rated current	2,1 I _{rat} max.	2,75 I _{rat}		4 I _{rat}		10 I _{rat}	
		min.	max.	min.	max.	min.	max.
32 mA – 100 mA	2 min	200 ms	10 s	40 ms	3 s	10 ms	300 ms
125 mA – 6,3 A	2 min	600 ms	10 s	150 ms	3 s	20 ms	300 ms

**Aufbau:**

Glasrohr, mit Löschmittel

Kontaktkappen:

Messing, vernickelt

Lötbarkeit: gemäß EN 60068-2-20**Verpackungsmöglichkeiten:**

100 St. = 10 x 10er Faltschachteln

1000 St. = Industrieverpackung (lose geschüttet in Faltkarton)

Als Baugruppe mit 2 Aufsteckkappen in beliebiger Form und Länge, fertig montiert

Construction:

Glasstube, with extinguishing agent

Contact caps:

Brass, nickel plated

Solderability: by EN 60068-2-20**Packing options:**

100 pcs. = 10 boxes of 10 pieces

1000 pcs. = Industrial box (loose in carton)

As assembly with two pigtails in various forms and lengths, finally mounted

Bemessungswerte / Ratings

Art.-No.	Strom Current	Spannung Voltage	Ausschaltvermögen Breaking capacity	Spannungsfall Voltage drop max [mV]	Schmelzintegral Melting integral [A ² s]
522.019	1,6 A	250 V	300 A	160	4,61
522.020	2 A	250 V	300 A	150	14,08
522.021	2,5 A	250 V	300 A	145	24,75
522.022	3,15 A	250 V	300 A	140	47,63
522.023	4 A	250 V	300 A	135	116,80
522.024	5 A	250 V	300 A	130	215,50
522.025	6,3 A	250 V	300 A	125	407,22
522.026	8 A	250 V	300 A	120	527,36
522.027	10 A	250 V	300 A	115	252,00
522.028 ¹⁾	12,5 A	250 V	300 A	128	428,13
522.030 ¹⁾	16 A	250 V	300 A	149	1644,80

Schmelzzeit-Grenzwert / Pre-arcing time limits

Bemessungsstrom Rated current	1,5 I _{rat}		2,1 I _{rat}		4 I _{rat}		10 I _{rat}	
	min.	max.	min.	max.	min.	max.	min.	max.
1,6 – 10 A	1 h		30 min.		300 ms	3.000 ms	60 ms	300 ms

1) Nicht in der Normreihe verzeichnet / Not mentioned in the standards

**Aufbau:**

Glasrohr, durchsichtig

Kontaktkappen:

Messing, vernickelt

Lötbarkeit: gemäß EN 60068-2-20**Verpackungsmöglichkeiten:**

100 St. = 10 x 10er Faltschachteln

1000 St. = Industrieverpackung (lose geschüttet in Faltkarton)

Als Baugruppe mit 2 Aufsteckkappen in beliebiger Form und Länge, fertig montiert

Construction:

Glasstube, transparent

Contact caps:

Brass, nickel plated

Solderability: by EN 60068-2-20**Packing options:**

100 pcs. = 10 boxes of 10 pieces

1000 pcs. = Industrial box (loose in carton)

As assembly with two pigtails in various forms and lengths, finally mounted

Bemessungswerte / Ratings

Art.-No.	Strom Current	Spannung Voltage	Ausschaltvermögen Breaking capacity	Spannungsfall Voltage drop max [mV]	Verlustleistung power dissip. max [W]	Schmelzintegral Melting integral [A ² s]
522.407	100 mA	250 V	35 A / 250 V~	1.500		0,056
522.408	125 mA	250 V	35 A / 250 V~	1.500		0,093
522.409	160 mA	250 V	35 A / 250 V~	1.500		0,39
522.410	200 mA	250 V	35 A / 250 V~	1.500		0,45
522.411	250 mA	250 V	35 A / 250 V~	1.500		0,40
522.412	315 mA	250 V	35 A / 250 V~	1.000		0,65
522.413	400 mA	250 V	35 A / 250 V~	800		0,67
522.414	500 mA	250 V	35 A / 250 V~	800		1,77
522.415	630 mA	250 V	35 A / 250 V~	800	auf Anfrage /	6,48
522.416	800 mA	250 V	35 A / 250 V~	800	on request	9,20
522.417	1 A	250 V	35 A / 250 V~	800		10,26
522.418	1,25 A	250 V	35 A / 250 V~	200		18,34
522.419	1,6 A	250 V	35 A / 250 V~	180		43,00
522.420	2 A	250 V	35 A / 250 V~	180		144,80
522.421	2,5 A	250 V	35 A / 250 V~	130		145,16
522.422	3,15 A	250 V	35 A / 250 V~	120		152,01
522.423	4 A	250 V	35 A / 250 V~	100		308,80
522.424	5 A	250 V	35 A / 250 V~	80		526,50
522.425	6,3 A	250 V	35 A / 250 V~	80		615,99
522.426	8 A	250 V	35 A / 250 V~	80		
522.427	10 A	250 V	35 A / 250 V~	80		1614,00

Schmelzzeit-Grenzwert / Pre-arcing time limits

Bemessungsstrom Rated current	1,5 I _{rat}		2,1 I _{rat}		2,75 I _{rat}		4 I _{rat}		10 I _{rat}	
	min.		min.		min.	max.	min.	max.	min.	max.
100 mA – 500 mA	1 h		30 min		2,5 s	180 s	750 ms	40 s	30 ms	3 s
630 mA – 10 A	1 h		30 min		2,5 s	180 s	1,0 s	40 s	100 ms	3 s



Aufbau:

32 mA - 1,25 A: Glasrohr, durchsichtig
1,6 A - 10 A: Glasrohr, mit Löschmittel

Kontaktkappen:

Messing, vernickelt

Lötbarkeit: gemäß EN 60068-2-20

Verpackungsmöglichkeiten:

100 St. = 10 x 10er Faltschachteln
1000 St. = Industrieverpackung (lose geschüttet in Faltkarton)

Als Baugruppe mit 2 Aufsteckkappen in beliebiger Form und Länge, fertig montiert

Construction:

32 mA-1,25 A: Glasstube, transparent
1,6 - 10 A: Glasstube, with extinguishing agent

Contact caps:

Brass, nickel plated

Solderability: by EN 60068-2-20

Packing options:

100 pcs. = 10 boxes of 10 pieces
1000 pcs. = Industrial box (loose in carton)
As assembly with two pigtails in various forms and lengths, finally mounted

Bemessungswerte / Ratings

Art.-No.	Strom Current	Spannung Voltage	Ausschaltvermögen Breaking capacity	Spannungsfall Voltage drop max [mV]	Schmelzintegral Melting integral [A ² s]
525.602	32 mA	250 V	50 A		
525.603	40 mA	250 V	50 A		auf Anfrage / on request
525.604	50 mA	250 V	50 A		
525.605	63 mA	250 V	50 A		
525.606	80 mA	250 V	50 A		
525.607	100 mA	250 V	50 A		0,0040
525.608	125 mA	250 V	50 A		0,0084
525.609	160 mA	250 V	50 A		0,015
525.610	200 mA	250 V	50 A	auf Anfrage / on request	0,028
525.611	250 mA	250 V	50 A		0,069
525.612	315 mA	250 V	50 A		0,16
525.613	400 mA	250 V	50 A		0,26
525.614	500 mA	250 V	50 A		0,25
525.615	630 mA	250 V	50 A		0,45
525.616	800 mA	250 V	50 A		
525.617	1 A	250 V	50 A		1,12
525.618	1,25 A	250 V	50 A		1,90
525.619	1,6 A	250 V	80 A		1,28
525.620	2 A	250 V	80 A		2,48
525.621	2,5 A	250 V	80 A		8,13
525.622	3,15 A	250 V	80 A		7,94
525.623	4 A	250 V	80 A		18,88
525.624	5 A	250 V	80 A		35,00
525.625	6,3 A	250 V	80 A		71,44
525.626	8 A	250 V	80 A		160,00
525.627	10 A	250 V	100 A		250,00

Schmelzzeit-Grenzwert / Pre-arcing time limits

Bemessungsstrom Rated current	1,5 I _{rat}	2,1 I _{rat}		4 I _{rat}		10 I _{rat}
	min.	min.	max.	min.	max.	max.
32 mA – 6,3 A	1 h	30 min		300 ms		20 ms
8 A – 10 A	1 h	30 min		300 ms		30 ms



Aufbau:

Keramikrohr, mit Löschmittel

Kontaktkappen:

Messing, vernickelt

Verpackungsmöglichkeiten:

100 St. = 10 x 10er Faltschachteln

1000 St. = Industrieverpackung (lose geschüttet in Faltkarton)

Construction:

Ceramic tube, with extinguishing agent

Contact caps:

Brass, nickel plated

Packing options:

100 pcs. = 10 boxes of 10 pieces

1000 pcs. = Industrial box (loose in carton)

Bemessungswerte / Ratings

Art.-No.	Strom Current	Spannung Voltage	Ausschaltvermögen Breaking capacity	Spannungsfall Voltage drop max [mV]	Schmelzintegral Melting integral [A ² s]
527.019	1,6 A	250 V	300 A	640	
527.020	2 A	250 V	300 A	420	
527.021	2,5 A	250 V	300 A	320	
527.022	3,15 A	250 V	300 A	250	auf Anfrage / on request
527.023	4 A	250 V	300 A	200	on request
527.024	5 A	250 V	300 A	180	
527.025	6,3 A	250 V	300 A	170	
527.026 ¹⁾	8 A	250 V	300 A	auf Anfrage / on request	
527.027 ¹⁾	10A	250 V	300 A	on request	

Schmelzzeit-Grenzwert / Pre-arcing time limits

Bemessungsstrom Rated current	1,5 I _{rat} min.	2,1 I _{rat} max.	4 I _{rat} max.	10 I _{rat} max.
1,6 – 6,3 A	1 h	30 min	300 ms	20 ms



Aufbau:

40 mA - 1,25 A: Glasrohr, durchsichtig
1,6 A - 10 A: Glasrohr, mit Löschmittel

Kontaktkappen:

Messing, vernickelt

Lötbarkeit: gemäß EN 60068-2-20

Verpackungsmöglichkeiten:

100 St. = 10 x 10er Faltschachteln
1000 St. = Industrieverpackung (lose geschüttet in Faltkarton)

Als Baugruppe mit 2 Aufsteckkappen in beliebiger Form und Länge, fertig montiert

Construction:

40 mA-1,25 A: Glasstube, transparent
1,6 -10 A: Glasstube, with extinguishing agent

Contact caps:

Brass, nickel plated

Solderability: by EN 60068-2-20

Packing options:

100 pcs. = 10 boxes of 10 pieces
1000 pcs. = Industrial box (loose in carton)
As assembly with two pigtailed in various forms and lengths, finally mounted

Bemessungswerte / Ratings

Art.-No.	Strom Current	Spannung Voltage	Ausschaltvermögen Breaking capacity	Spannungsfall Voltage drop max [mV]	Schmelzintegral Melting integral [A ² s]
525.203	40 mA	250 V	80 A		
525.204	50 mA	250 V	80 A		
525.205	63 mA	250 V	80 A		
525.206	80 mA	250 V	80 A		
525.207	100 mA	250 V	80 A		
525.208	125 mA	250 V	80 A		
525.209	160 mA	250 V	80 A		
525.210	200 mA	250 V	80 A		
525.211	250 mA	250 V	80 A	auf Anfrage / on request	auf Anfrage / on request
525.212	315 mA	250 V	80 A		
525.213	400 mA	250 V	80 A		
525.214	500 mA	250 V	80 A		
525.215	630 mA	250 V	80 A		
525.216	800 mA	250 V	80 A		
525.217	1 A	250 V	80 A		
525.218	1,25 A	250 V	80 A		
525.219	1,6 A	250 V	80 A		
525.220	2 A	250 V	80 A		
525.221	2,5 A	250 V	80 A		
525.222	3,15 A	250 V	80 A		
525.223	4 A	250 V	80 A		
525.224	5 A	250 V	80 A		
525.225	6,3 A	250 V	80 A		
525.226	8 A	250 V	80 A		
525.227	10A	250 V	100 A		

Schmelzzeit-Grenzwert / Pre-arcing time limits

Bemessungsstrom Rated current	1,5 I _{rat}		2,1 I _{rat}		4 I _{rat}		10 I _{rat}	
	min.	max.	min.	max.	min.	max.	min.	max.
40 mA – 1,25 A	1 h		10 min.		40 ms	2.000 ms	5 ms	90 ms
1,6 mA – 10 A	1 h		30 min		40 ms	2.000 ms	5 ms	90 ms



Aufbau:

80 mA - 630 mA: Glasrohr, durchsichtig
800 mA - 16 A: Keramikrohr

Kontaktkappen:

Messing, vernickelt

Verpackungsmöglichkeiten:

100 St. = 10 x 10er Faltschachteln
1000 St. = Industrieverpackung (lose geschüttet in Faltkarton)

Construction:

80 mA -630 mA: Glasstube, transparent
800 mA -16 A: Ceramictube

Contact caps:

Brass, nickel plated

Packing options:

100 pcs. = 10 boxes of 10 pieces
1000 pcs. = Industrial box (loose in carton)

Bemessungswerte / Ratings

Art.-No.	Strom Current	Spannung Voltage	Ausschaltvermögen Breaking capacity	Spannungsfall Voltage drop max [mV]	Schmelzintegral Melting integral [A ² s]
528.006	80 mA	250 V	80 A	520	
528.007	100 mA	250 V	80 A	500	
528.008	125 mA	250 V	80 A	500	
528.009	160 mA	250 V	80 A	400	
528.010	200 mA	250 V	80 A	400	
528.011	250 mA	250 V	80 A	375	
528.012	315 mA	250 V	80 A	410	
528.013	400 mA	250 V	80 A	280	auf Anfrage /
528.014	500 mA	250 V	80 A	250	on request
528.015	630 mA	250 V	80 A	220	
528.016	800 mA	250 V	1.500 A	400	
528.017	1 A	250 V	1.500 A	350	
528.018	1,25 A	250 V	1.500 A	315	
528.019	1,6 A	250 V	1.500 A	480	
528.020	2 A	250 V	1.500 A	360	
528.021	2,5 A	250 V	1.500 A	300	
528.022	3,15 A	250 V	1.500 A	250	
528.023	4 A	250 V	1.500 A	180	
528.024	5 A	250 V	1.500 A	180	
528.025	6,3 A	250 V	1.500 A	160	
528.026 ¹⁾	8 A	250 V	1.500 A	auf Anfrage /	
528.027 ¹⁾	10 A	250 V	1.500 A	on request	
528.030 ¹⁾	16 A	250 V	1.500 A		

Schmelzzeit-Grenzwert / Pre-arcing time limits

Bemessungsstrom Rated current	1,5 I _{rat}		2,1 I _{rat}		4 I _{rat}		10 I _{rat}	
	min.	max.	min.	max.	min.	max.	min.	max.
80 mA – 100 mA	1 h	2 min.	40 ms	500 ms	5 ms	30 ms		
125 mA – 1,25 A	1 h	2 min	60 ms	2.000 ms	5 ms	70 ms		
1,6 A – 10 A	1 h	30 min.	60 ms	2.000 ms	5 ms	70 ms		



Aufbau:

Keramikrohr

Kontaktkappen:

Messing vernickelt

Verpackungsmöglichkeiten:

Industrieverpackung (lose gescl)

Construction:

Insulating tube ceramic

Contact caps:

Brass, nickel-plated

Packing opinions:

Industrial box (loose in carton)

Bemessungswerte / Ratings

Art.-No.	Strom Current	Spannung Voltage	Ausschaltvermögen Breaking capacity	Spannungsfall Voltage drop max [mV]	Kennmelderfarbe indicator colour
528.102	32 mA	250 V	80 A	800	Schwarz / black
528.104	50 mA	250 V	80 A	900	Weiß / white
528.105	63 mA	250 V	80 A	760	Grün / green
528.106	80 mA	250 V	80 A	520	Grau / gray
528.107	100 mA	250 V	80 A	500	Rot / red
528.108	125 mA	250 V	80 A	500	Violett / violet
528.109	160 mA	250 V	80 A	400	Orange / orange
528.110	200 mA	250 V	80 A	400	Blau / blue
528.111	250 mA	250 V	1500 A	500	Gelb / yellow
528.112	315 mA	250 V	1500 A	470	Schwarz / black
528.113	400 mA	250 V	1500 A	400	Braun / brown
528.114	500 mA	250 V	1500 A	400	Weiß / white
528.115	630 mA	250 V	1500 A	380	Grün / green
528.116	800 mA	250 V	1500 A	400	Grau / gray
528.117	1 A	250 V	1500 A	350	Rot / red
528.118	1,25 A	250 V	1500 A	310	Violett / violet
528.119	1,6 A	250 V	1500 A	480	Orange /orange
528.120	2 A	250 V	1500 A	360	Blau / blue
528.121	2,5 A	250 V	1500 A	300	Gelb / yellow
528.123	4 A	250 V	1500 A	180	Braun / brown
528.125	6,3 A	250 V	1500 A	160	Grün / green
528.127	10 A	250 V	1500 A	100	Rot / red

Schmelzzeit-Grenzwert / Pre-arcing time limits

Bemessungsstrom Rated current	1,5 I _{rat}		2,1 I _{rat}		4 I _{rat}		10 I _{rat}	
	min.	max.	min.	max.	min.	max.	min.	max.
32 mA – 100 mA	1 h		2 min		40 ms	500 ms	5 ms	30 ms
125 mA – 630 mA	1 h		2 min		60 ms	2000ms	5 ms	70 ms
800 mA – 10 A	1 h		30 min		60 ms	2000ms	5 ms	70 ms



Aufbau:

32 A – 1,25 A: Glasrohr, durchsichtig
1,6 A - 10 A: Glasrohr mit Löschmittel

Kontaktkappen:

Messing, vernickelt

Verpackungsmöglichkeiten:

100 St. = 10 x 10er Faltschachteln
1000 St. = Industrieverpackung (lose geschüttet in Faltkarton)
Als Baugruppe mit 2 Aufsteckkappen in beliebiger Form und Länge, fertig montiert

Construction:

32 mA -1,25 A: Glasstube, transparent
1,6 A - 10 A: Glasstube, with extinguishing agent

Contact caps:

Brass, nickel plated

Packing options:

100 pcs. = 10 boxes of 10 pieces
1000 pcs. = Industrial box (loose in carton)
As assembly with two pigtails in various forms and lengths, finally mounted

Bemessungswerte / Ratings

Art.-No.	Strom Current	Spannung Voltage	Ausschaltvermögen Breaking capacity	Spannungsfall Voltage drop max [mV]	Schmelzintegral Melting integral [A ² s]
530.602	32 mA	500 V	50 A		
530.603	40 mA	500 V	50 A		
530.604	50 mA	500 V	50 A		auf Anfrage / on request
530.605	63 mA	500 V	50 A		
530.606	80 mA	500 V	50 A		
530.607	100 mA	500 V	50 A		0,0040
530.608	125 mA	500 V	50 A		0,0094
530.609	160 mA	500 V	50 A		0,015
530.610	200 mA	500 V	50 A	auf Anfrage / on request	0,031
530.611	250 mA	500 V	50 A		
530.612	315 mA	500 V	50 A		0,14
530.613	400 mA	500 V	50 A		0,24
530.614	500 mA	500 V	50 A		0,25
530.615	630 mA	500 V	50 A		0,48
530.616	800 mA	500 V	50 A		0,58
530.617	1 A	500 V	50 A		1,20
530.618	1,25 A	500 V	50 A		2,03
530.619	1,6 A	500 V	50 A		1,28
530.620	2 A	500 V	80 A		6,56
530.621	2,5 A	500 V	80 A		9,13
530.622	3,15 A	500 V	80 A		9,53
530.623	4 A	500 V	80 A		24,00
530.624	5 A	500 V	80 A		43,00
530.625	6,3 A	500 V	80 A		91,69
530.626	8 A	500 V	80 A		139,52
530.627	10 A	500 V	100 A		220,00

Schmelzzeit-Grenzwert / Pre-arcing time limits

Bemessungsstrom Rated current	1,5 I _{rat} min.	2,1 I _{rat} max.	4 I _{rat} max.	10 I _{rat} max.
32 mA – 6,3 mA	1 h	30 min.	300 ms	20 ms

**Aufbau:**

32 mA – 1,25 A: Glasrohr, durchsichtig

1,6 A - 10 A: Glasrohr mit Löschmittel

Kontaktkappen:

Messing, vernickelt

Lötbarkeit: gemäß EN 60068-2-20**Verpackungsmöglichkeiten:**

100 St. = 10 x 10er Faltschachteln

1000 St. = Industrieverpackung (lose geschüttet in Faltkarton)

Als Baugruppe mit 2 Aufsteckkappen in beliebiger Form und Länge, fertig montiert

Construction:

32 mA -1,25 A: Glasstube, transparent

1,6 A -10 A: Glasstube, with extinguishing agent

Contact caps:

Brass, nickel plated

Solderability: by EN 60068-2-20**Packing options:**

100 pcs. = 10 boxes of 10 pieces

1000 pcs. = Industrial box (loose in carton)

As assembly with two pigtails in various forms and lengths, finally mounted

Bemessungswerte / Ratings

Art.-No.	Strom Current	Spannung Voltage	Ausschaltvermögen Breaking capacity	Spannungsfall Voltage drop max [mV]	Schmelzintegral Melting integral [A ² s]
530.202	32 mA	500 V	80 A		
530.203	40 mA	500 V	80 A		auf Anfrage / on request
530.204	50 mA	500 V	80 A		
530.205	63 mA	500 V	80 A		
530.206	80 mA	500 V	80 A		
530.207	100 mA	500 V	80 A		0,0080
530.208	125 mA	500 V	80 A		0,013
530.209	160 mA	500 V	80 A		0,035
530.210	200 mA	500 V	80 A	auf Anfrage / on request	0,080
530.211	250 mA	500 V	80 A		0,20
530.212	315 mA	500 V	80 A		0,056
530.213	400 mA	500 V	80 A		0,13
530.214	500 mA	500 V	80 A		0,18
530.215	630 mA	500 V	80 A		0,40
530.216	800 mA	500 V	80 A		0,56
530.217	1 A	500 V	80 A		1,20
530.218	1,25 A	500 V	80 A		2,66
530.219	1,6 A	500 V	80 A		3,74
530.220	2 A	500 V	80 A		3,52
530.221	2,5 A	500 V	80 A		16,38
530.222	3,15 A	500 V	80 A		9,92
530.223	4 A	500 V	80 A		23,68
530.224	5 A	500 V	80 A		54,00
530.225	6,3 A	500 V	80 A		61,92
530.226	8 A	500 V	80 A		204,80
530.227	10 A	500 V	100 A		235,00

Schmelzzeit-Grenzwert / Pre-arcing time limits

Bemessungsstrom Rated current	1,5 I _{rat} min.	2,1 I _{rat} max.	4 I _{rat}		10 I _{rat}	
			min	max.	min.	max.
32 mA – 1,25 A 1,6 A – 10 A	1 h 1 h	10 min. 30 min.	40 ms 40 ms	2000 ms 2000 ms	5 ms 5 ms	90 ms 90 ms



Aufbau:

250 mA – 1,25 A: Glasrohr, durchsichtig
1,6 A – 16 A: Keramikrohr, mit Löschmittel

Kontaktkappen:

Messing, vernickelt

Lötbarkeit: gemäß EN 60068-2-20

Verpackungsmöglichkeiten:

100 St. = 10 x 10er Faltschachteln
500 St. = Industrieverpackung (lose geschüttet in Faltkarton)

Als Baugruppe mit 2 Aufsteckkappen in beliebiger Form und Länge, fertig montiert

Construction:

250 mA – 1,25 A: Glasstube, transparent
1,6 A – 16 A: Ceramictube, with extinguishing agent

Contact caps:

Brass, nickel plated

Solderability: by EN 60068-2-20

Packing options:

100 pcs. = 10 boxes of 10 pieces
500 pcs. = Industrial box (loose in carton)
As assembly with two pigtails in various forms and lengths, finally mounted

Bemessungswerte / Ratings

Art.-No.	Strom Current	Spannung Voltage	Ausschaltvermögen Breaking capacity	Spannungsfall Voltage drop max [mV]	Schmelzintegral Melting integral [A ² s]
632.111	250 mA	250 V	35 A		0,037
632.112	315 mA	250 V	35 A		0,042
632.113	400 mA	250 V	35 A		0,18
632.114	500 mA	250 V	35 A		0,24
632.115	630 mA	250 V	35 A		0,18
632.116	800 mA	250 V	35 A		0,45
632.117	1 A	250 V	35 A		0,30
632.118	1,25 A	250 V	35 A		2,00
632.119	1,6 A	500 V	1.500 A	auf Anfrage /	0,51
632.120	2 A	500 V	1.500 A	on request	5,04
632.121	2,5 A	500 V	1.500 A		2,00
632.122	3,15 A	500 V	1.500 A		1,78
632.123	4 A	500 V	1.500 A		6,40
632.124	5 A	500 V	1.500 A		15,00
632.125	6,3 A	500 V	1.500 A		15,88
632.126	8 A	500 V	1.500 A		69,12
632.127	10 A	500 V	1.500 A		110,00
632.128	12,5 A	500 V	1.500 A		187,50
632.130	16 A	500 V	1.500 A		343,04
632.131	20 A	250 V			1412,00
632.132	25 A	250 V			3975,00

Schmelzzeit-Grenzwert / Pre-arcing time limits

Bemessungsstrom Rated current	1,15 I _{rat} min.	1,5 I _{rat} max.	2,0 I _{rat} max.	10 I _{rat} max.
250 mA – 8 A 10 A – 25 A	1 h 1 h	30 min. 30 min.	3 s 3 s	15 ms 15 ms



Aufbau:

Keramikrohr, mit Löschmittel

Kontaktkappen:

Messing, vernickelt

Verpackungsmöglichkeiten:

100 St. = 10 x 10er Faltschachteln

500 St. = Industrieverpackung (lose geschüttet in Faltkarton)

Als Baugruppe mit 2 Aufsteckkappen in beliebiger Form und Länge, fertig montiert

Construction:

Ceramic tube, with extinguishing agent

Contact caps:

Brass, nickel plated

Packing options:

100 pcs. = 10 boxes of 10 pieces

500 pcs. = Industrial box (loose in carton)

As assembly with two pigtailed in various forms and lengths, finally mounted

Bemessungswerte / Ratings

Art.-No.	Strom Current	Spannung Voltage	Ausschaltvermögen Breaking capacity	Spannungsfall Voltage drop max [mV]	Verlustleistung power dissip. Max [W]	Schmelzintegral Melting integral [A ² s]
632.507	100 mA	500 V	1000 A / 500 V	8.000	1,6	0,0040
632.508	125 mA	500 V	1000 A / 500 V	6.000	1,6	0,0088
632.509	160 mA	500 V	1000 A / 500 V	5.000	1,6	0,0015
632.510	200 mA	500 V	1000 A / 500 V	4.000	1,6	0,0032
632.511	250 mA	500 V	1000 A / 500 V	3.500	2,5	0,063
632.512	315 mA	500 V	1000 A / 500 V	3.000	2,5	0,13
632.513	400 mA	500 V	1000 A / 500 V	2.500	2,5	0,24
632.514	500 mA	500 V	1000 A / 500 V	2.000	2,5	0,23
632.515	630 mA	500 V	1000 A / 500 V	2.000	2,5	0,12
632.516	800 mA	500 V	1000 A / 500 V	800	2,5	0,17
632.517	1 A	500 V	1000 A / 500 V	700	2,5	0,30
632.518	1,25 A	500 V	1000 A / 500 V	600	2,5	auf Anfrage
632.519	1,6 A	500 V	1000 A / 500 V	500	2,5	0,77
632.520	2 A	500 V	1000 A / 500 V	400	2,5	1,60
632.521	2,5 A	500 V	1000 A / 500 V	300	4	9,25
632.522	3,15 A	500 V	1000 A / 500 V	300	4	6,95
632.523	4 A	500 V	1000 A / 500 V	300	4	19,20
632.524	5 A	500 V	1000 A / 500 V	250	4	38,50
632.525	6,3 A	500 V	1000 A / 500 V	250	4	38,90
632.526	8 A	500 V	1000 A / 500 V	200	4	154,88
632.527	10 A	500 V	1000 A / 500 V	200	4	206,00
632.528 ¹⁾	12,5 A	500 V	1000 A / 500 V	auf Anfrage /	4	418,75
632.530 ¹⁾	16 A	500 V	1000 A / 500 V	on request	4	701,44

Schmelzzeit-Grenzwert / Pre-arcing time limits

Bemessungsstrom Rated current	2,1 I _{rat} max.	min. 2,75 I _{rat} max.	min. 4 I _{rat} max.	10 I _{rat} max.
100 mA – 800 mA 1 A – 10 A	1.800 s 1.800 s	20 ms 1.500 ms 50 ms 5.000 ms	8 ms 400 ms 20 ms 1.000 ms	20 ms 50 ms

1) Nicht in der Normreihe verzeichnet / Not mentioned in the standards

G-Sicherungseinsätze

No. UL 632.500

Fuse-links quick-acting

6,3 x 32 mm

flink



F
UL No. 248-14



ESKA



Aufbau:

Keramikrohr

Kontaktkappen:

Messing, vernickelt

Verpackungsmöglichkeiten:

100 St. = 10 x 10er Faltschachteln

500 St. / 1000 St. = Industrieverpackung (lose geschüttet in Faltkarton)

Als Baugruppe mit 2 Aufsteckkappen in beliebiger Form und Länge, fertig montiert

Construction:

Ceramic tube

Contact caps:

Brass, nickel plated

Packing opinions:

100 pcs. = 10 boxes of 10 pieces

500 pcs. / 1000 pcs. = Industrial box (loose in carton) As assembly with two pigtails in various forms and lengths, finally mounted

Bemessungswerte / Ratings

Art.-No.	Strom Current (A)	Spannung Voltage	Ausschaltvermögen Breaking capacity	Spannungsfall Voltage drop (Volt) max.	Max. Verlustleistung Max. power dissipation [W]	Schmelzintegral Melting integral [A ² S]
UL 632.507	100 mA	250 V	35 A	4,5	0,59	0,002
UL 632.508	125 mA	250 V	35 A	4,5	0,74	0,004
UL 632.509	160 mA	250 V	35 A	4,2	0,87	0,008
UL 632.510	200 mA	250 V	35 A	3,9	1,02	0,014
UL 632.511	250 mA	250 V	35 A	3,6	1,19	0,025
UL 632.512	300 mA	250 V	35 A	3,4	1,40	0,044
UL 632.534	375 mA	250 V	35 A	3,2	1,58	0,07
UL 632.514	500 mA	250 V	35 A	1,1	1,92	0,14
UL 632.535	750 mA	250 V	35 A	0,2	0,30	0,75
UL 632.517	1 A	250 V	35 A	0,23	0,37	1,43
UL 632.518	1,25 A	250 V	100 A	0,21	0,44	2,45
UL 632.519	1,6 A	250 V	100 A	0,20	0,51	4,2
UL 632.520	2 A	250 V	100 A	0,18	0,59	7,2
UL 632.521	2,5 A	250 V	100 A	0,170	0,70	12
UL 632.560	3 A	250 V	100 A	0,162	0,83	21
UL 632.522	3,5 A	250 V	100 A	0,157	0,91	28
UL 632.523	4 A	250 V	200 A	0,154	1,0	36
UL 632.524	5 A	250 V	200 A	0,146	1,2	63
UL 632.525	6 A	250 V	200 A	0,139	1,4	107
UL 632.561	7 A	250 V	200 A	0,135	1,6	141
UL 532.526	8 A	250 V	200 A	0,132	1,7	184
UL 532.527	10 A	250 V	200 A	0,125	2,0	316

Electrical Characteristics

Prüfstrom Testing current	Schmelzzeit / Blow Time	
	Minimum	Maximum
100 %	4 Hrs	N / A
135 %	N / A	1 Hr
200 %	N / A	5 sec

**Aufbau:**

Glasrohr, durchsichtig

Kontaktkappen:

Messing, vernickelt

Lötbarkeit: gemäß EN 60068-2-20**Verpackungsmöglichkeiten:**

100 St. = 10 x 10er Faltschachteln

500 St. = Industrieverpackung (lose geschüttet in Faltkarton)

Als Baugruppe mit 2 Aufsteckkappen in beliebiger Form und Länge, fertig montiert

Construction:

Glasstube, transparent

Contact caps:

Brass, nickel plated

Solderability: by EN 60068-2-20**Packing options:**

100 pcs. = 10 boxes of 10 pieces

500 pcs. = Industrial box (loose in carton)

As assembly with two pigtails in various forms and lengths, finally mounted

Bemessungswerte / Ratings

Art.-No.	Strom Current	Spannung Voltage	Ausschaltvermögen Breaking capacity	Spannungsfall Voltage drop max [mV]	Verlustleistung power dissip. Max [W]	Schmelzintegral Melting integral [A ² s]
632.602 ¹⁾	32 mA	250 V	35 A	auf Anfrage / on request	auf Anfrage / on request	0,0006
632.603 ¹⁾	40 mA	250 V	35 A	auf Anfrage / on request	auf Anfrage / on request	auf Anfrage
632.604	50 mA	250 V	35 A	10.000	1,6	0,0013
632.605	63 mA	250 V	35 A	8.000	1,6	0,0017
632.606	80 mA	250 V	35 A	7.000	1,6	0,0016
632.607	100 mA	250 V	35 A	6.000	1,6	0,0020
632.608	125 mA	250 V	35 A	5.500	1,6	0,0047
632.609	160 mA	250 V	35 A	5.000	1,6	0,010
632.610	200 mA	250 V	35 A	4.000	1,6	0,020
632.611	250 mA	250 V	35 A	3.500	1,6	0,035
632.612	315 mA	250 V	35 A	3.000	1,6	0,059
632.613	400 mA	250 V	35 A	2.500	1,6	0,13
632.614	500 mA	250 V	35 A	2.000	1,6	0,25
632.615	630 mA	250 V	35 A	1.800	1,6	0,48
632.616	800 mA	250 V	35 A	1.500	1,6	0,58
632.617	1 A	250 V	35 A	500	1,6	1,20
632.618	1,25 A	250 V	35 A	400	2,5	2,66
632.619	1,6 A	250 V	35 A	400	2,5	4,30
632.620	2 A	250 V	35 A	300	2,5	6,80
632.621	2,5 A	150 V	35 A	250	2,5	14,50
632.622	3,15 A	150 V	35 A	250	4	17,66
632.623	4 A	150 V	40 A	250	4	43,20
632.624	5A	60 V	50 A	200	4	79,50
632.625	6,3 A	60 V	63 A	200	4	103,99
632.626	8 A	60 V	80 A	200	4	267,52
632.627	10 A	60 V	100 A	200	4	294,00
632.628 ¹⁾	12,5 A	60 V	100 A	auf Anfrage / on request	auf Anfrage / on request	768,75
632.630 ¹⁾	16 A	60 V	100 A	auf Anfrage / on request	auf Anfrage / on request	1100,80

Schmelzzeit-Grenzwert / Pre-arcing time limits

Bemessungsstrom Rated current	2,0 I _{rat} max.	min. 2,75 I _{rat} max.	min. 4 I _{rat} max.	10 I _{rat} max.
50 mA – 100 mA 125 mA - 10 A	120 s 120 s	2 ms 20 ms	200 ms 1.500 ms	1 ms 8 ms
				30ms 400 ms
				5 ms 80 ms

1) Nicht in der Normreiheverzeichnis / Not mentioned in the standards



Aufbau:

Glasrohr, mit Löschmittel

Kontakt-kappen:

Messing, vernickelt

Lötbarkeit: gemäß EN 60068-2-20

Verpackungsmöglichkeiten:

100 St. = 10 x 10er Faltschachteln

500 St. = Industrieverpackung (lose geschüttet in Faltkarton)

Als Baugruppe mit 2 Aufsteckkappen in beliebiger Form und Länge, fertig montiert

Construction:

Glasstube, with extinguishing agent

Contact caps:

Brass, nickel plated

Solderability: by EN 60068-2-20

Packing opinions:

100 pcs. = 10 boxes of 10 pieces

500 pcs. = Industrial box (loose in carton)

As assembly with two pigtails in various form and lengths, finally mounted

Bemessungswerte / Ratings

Art.-No.	Strom Current	Spannung Voltage	Ausschaltvermögen Breaking capacity	Spannungsfall Voltage drop max [mV]	Schmelzintegral Melting integral [A ² s]
632.006	80 mA	250 V	1.000 A	10.000	
632.007	100 mA	250 V	1.000 A	6.000	
632.008	125 mA	250 V	1.000 A	6.000	
632.009	160 mA	250 V	1.000 A	6.000	
632.010	200 mA	250 V	1.000 A	6.000	
632.011	250 mA	250 V	1.000 A	6.000	
632.012	315 mA	250 V	1.000 A	6.000	
632.013	400 mA	250 V	1.000 A	6.000	
632.014	500 mA	250 V	1.000 A	5.000	
632.015	630 mA	250 V	1.000 A	5.000	
632.016	800 mA	250 V	1.000 A	5.000	auf Anfrage / on request
632.017	1 A	250 V	1.000 A	2.000	
632.018	1,25 A	250 V	1.000 A	500	
632.019	1,6 A	250 V	1.000 A	500	
632.020	2 A	250 V	1.000 A	450	
632.021	2,5 A	250 V	1.000 A	400	
632.022	3,15 A	250 V	1.000 A	350	
632.023	4 A	250 V	1.000 A	350	
632.024	5 A	250 V	1.000 A	300	
632.025	6,3 A	250 V	1.000 A	300	
632.026	8 A	250 V	1.000 A	250	
632.027	10 A	250 V	1.000 A	250	
632.028	12,5 A	250 V	1.000 A	180	
632.030	16 A	250 V	1.000 A	250	

Schmelzzeit-Grenzwert / Pre-arcing time limits

Bemessungsstrom Rated current	1,15 I _{rat}		2,0 I _{rat}		2,75 I _{rat}		4 I _{rat}		10 I _{rat}
	min..	max.	min	max.	min	max.	min	max.	
80 mA – 1,25 A	1 h	10 min.	20 ms	3 s	8 ms	60 ms		30 ms	
1,6 A – 16 A	1 h	10 min.	20 ms	3s	----	300ms			



Aufbau:

Glasrohr, durchsichtig

Kontaktkappen:

Messing, vernickelt

Verpackungsmöglichkeiten:

100 St. = 10 x 10er Faltschachteln

500 St. / 1000 St. = Industrieverpackung (lose geschüttet in Faltkarton)

Als Baugruppe mit 2 Aufsteckkappen in beliebiger Form und Länge, fertig montiert

Construction:

Glasstube, transparent

Contact caps:

Brass, nickel plated

Packing opinions:

100 pcs. = 10 boxes of 10 pieces

500 pcs. / 1000 pcs. = Industrial box (loose in carton) As assembly with two pigtailed in various forms and lengths, finally mounted

Bemessungswerte / Ratings

Art.-No.	Strom Current (A)	Spannung Voltage	Ausschaltvermögen Breaking capacity	Spannungsfall Voltage drop (Volt) max.	Max. Verlustleistung Max. power dissipation [W]	Schmelzintegral Melting integral [A ² S]
UL 632.607	100 mA	250 V	200 A	4,5	0,59	0,002
UL 632.608	125 mA	250 V	200 A	4,5	0,80	0,004
UL 632.609	160 mA	250 V	200 A	4,2	0,94	0,008
UL 632.610	200 mA	250 V	200 A	3,9	1,10	0,014
UL 632.611	250 mA	250 V	200 A	3,6	1,29	0,025
UL 632.612	300 mA	250 V	200 A	3,4	1,51	0,044
UL 632.634	375 mA	250 V	200 A	3,2	1,64	0,071
UL 632.613	400 mA	250 V	200 A	3,1	1,71	0,080
UL 632.614	500 mA	250 V	200 A	2,9	1,88	0,14
UL 632.635	750 mA	250 V	200 A	2,3	2,15	0,19
UL 632.617	1 A	250 V	200 A	0,27	0,37	1,4
UL 632.618	1,25 A	250 V	200 A	0,24	0,44	2,4
UL 632.619	1,6 A	250 V	200 A	0,22	0,51	4,2
UL 632.620	2 A	250 V	200 A	0,20	0,59	7,2
UL 632.621	2,5 A	250 V	200 A	0,18	0,70	12
UL 632.660	3 A	250 V	200 A	0,170	0,83	21
UL 632.622	3,5 A	250 V	200 A	0,157	0,91	28
UL 632.623	4 A	250 V	200 A	0,154	1,0	36
UL 632.624	5 A	250 V	200 A	0,146	1,2	63
UL 632.625	6 A	250 V	200 A	0,139	1,4	107
UL 632.661	7 A	250 V	200 A	0,135	1,6	141
UL 632.626	8 A	250 V	200 A	0,132	1,7	184
UL 632.627	10 A	250 V	200 A	0,125	2,0	316
UL 632.628	12 A	125 V	10.000 A	0,120	2,4	501
UL 632.629	15 A	125 V	10.000 A	0,114	2,8	845

Electrical Characteristics

Prüfstrom Testing current	Schmelzzeit / Blow Time	
	Minimum	Maximum
100 %	4 Hrs	N / A
135 %	N / A	1 Hr
200 %	N / A	5 sec



Aufbau:

32 mA – 1,25 A: Glasrohr, durchsichtig
1,6 – 16 A: Glasrohr, mit Löschmittel

Kontaktkappen:

Messing, vernickelt

Lötbarkeit: gemäß EN 60068-2-20

Verpackungsmöglichkeiten:

100 St. = 10 x 10er Faltschachteln
500 St. = Industrieverpackung (lose geschüttet in Faltkarton)

Als Baugruppe mit 2 Aufsteckkappen in beliebiger Form und Länge, fertig montiert

Construction:

32 mA – 1,25 A: Glasstube, transparent
1,6 – 16 A: Glasstube, with extinguishing agent

Contact caps:

Brass, nickel plated

Solderability: by EN 60068-2-20

Packing options:

100 pcs. = 10 boxes of 10 pieces
500 pcs. = Industrial box (loose in carton)
As assembly with two pigtails in various forms and lengths, finally mounted

Bemessungswerte / Ratings

Art.-No.	Strom Current	Spannung Voltage	Ausschaltvermögen Breaking capacity	Spannungsfall Voltage drop max [mV]	Schmelzintegral Melting integral [A ² s]
632.202	32 mA	250 V	35 A	12.000	auf Anfrage /
632.204	50 mA	250 V	35 A	3.500	on request
632.205	63 mA	250 V	35 A	3.000	0,0062
632.206	80 mA	250 V	35 A	2.500	
632.207	100 mA	250 V	35 A	2.000	0,052
632.208	125 mA	250 V	35 A	1.000	
632.209	160 mA	250 V	35 A	1.000	0,013
632.210	200 mA	250 V	35 A	1.000	0,036
632.211	250 mA	250 V	35 A	1.000	0,080
632.212	315 mA	250 V	35 A	1.000	0,19
632.213	400 mA	250 V	35 A	1.000	0,12
632.214	500 mA	250 V	35 A	500	0,13
632.215	630 mA	250 V	35 A	350	0,30
632.216	800 mA	250 V	35 A	320	0,56
632.217	1 A	250 V	35 A	300	1,17
632.218	1,25 A	250 V	35 A	250	1,90
632.219	1,6 A	250 V	1.000 A	400	3,00
632.220	2 A	250 V	1.000 A	400	1,28
632.221	2,5 A	250 V	1.000 A	350	1,60
632.222	3,15 A	250 V	1.000 A	300	5,00
632.223	4 A	250 V	1.000 A	250	7,54
632.224	5 A	250 V	1.000 A	250	13,76
632.225	6,3 A	250 V	1.000 A	250	51,50
632.226	8 A	250 V	1.000 A	250	89,70
632.227	10 A	250 V	1.000 A	250	111,36
632.228	12,5 A	250 V	1.000 A	250	228,00
632.230	16 A	250 V	1.000 A	220	428,13

Schmelzeit-Grenzwert / Pre-arcing time limits

Bemessungsstrom Rated current	1,15 I _{rat} min..	2,0 I _{rat} min.	2,75 I _{rat} Max.	4 I _{rat} max.	10 I _{rat} max.
32 mA – 1,25 A 1,6 A – 16 A	1 h 1 h	10 min. 30 min.	2 s 2 s	500 ms 500 ms	50 ms 50 ms

**Aufbau:**

32 mA – 2 A: Glasrohr, durchsichtig
2,5 A – 16 A: Glasrohr, mit Löschmittel

Kontaktkappen:

Messing, vernickelt

Lötbarkeit: gemäß EN 60068-2-20

Verpackungsmöglichkeiten:

100 St. = 10 x 10er Faltschachteln
500 St. = Industrieverpackung (lose geschüttet
in Faltkarton)

Als Baugruppe mit 2 Aufsteckkappen in
beliebiger Form und Länge, fertig montiert

Construction:

32 mA – 2 A: Glasstube, transparent
2,5 A – 16 A: Glasstube, with extinguishing agent

Contact caps:

Brass, nickel plated

Solderability: by EN 60068-2-20

Packing options:

100 pcs. = 10 boxes of 10 pieces
500 pcs. = Industrial box (loose in carton)
As assembly with two pigtails in various forms and
lengths, finally mounted

Bemessungswerte / Ratings

Art.- No.	Strom Current	Spannung Voltage	Ausschaltvermögen Breaking capacity	Spannungsfall Voltage drop max [mV]	Schmelzintegral Melting integral [A ² s]
632.302	32 mA	250 V	35 A	14.000	
632.303	40 mA	250 V	35 A	4.000	
632.304	50 mA	250 V	35 A	3.500	
632.305	63 mA	250 V	35 A	2.000	
632.306	80 mA	250 V	35 A	2.000	
632.307	100 mA	250 V	35 A	2.000	0,076
632.308	125 mA	250 V	35 A	1.000	
632.309	160 mA	250 V	35 A	750	0,032
632.310	200 mA	250 V	35 A	750	0,11
632.311	250 mA	250 V	35 A	650	0,026
632.312	315 mA	250 V	35 A	650	0,32
632.313	400 mA	250 V	35 A	1.700	0,13
632.314	500 mA	250 V	35 A	1.600	0,36
632.315	630 mA	250 V	35 A	180	
632.316	800 mA	250 V	35 A	180	5,62
632.317	1 A	250 V	35 A	180	5,80
632.318	1,25 A	250 V	35 A	180	11,78
632.319	1,6 A	250 V	35 A	180	6,40
632.320	2 A	250 V	35 A	180	55,68
632.321	2,5 A	250 V	1.000 A	300	4,63
632.322	3,15 A	250 V	1.000 A	300	7,54
632.323	4 A	250 V	1.000 A	300	18,88
632.324	5 A	250 V	1.000 A	300	42,50
632.325	6,3 A	250 V	1.000 A	300	63,50
632.326	8 A	250 V	1.000 A	200	158,72
632.327	10 A	250 V	1.000 A	200	230,00
632.328	12,5 A	250 V	1.000 A	200	400,00
632.330	16 A	250 V	1.000 A	180	913,50

Schmelzzeit-Grenzwert / Pre-arcing time limits

Bemessungsstrom Rated current	1,15 I _{rat}		2,0 I _{rat}		2,75 I _{rat}		4 I _{rat}		10 I _{rat}	
	min.	max.	min.	max.	min.	max.	min.	max.	min.	max.
32 mA – 2 A	1 h	10 min.	150 ms	5 s	60 ms	1 s	200 ms			
2,5 A – 10 A	1 h	30 min.	300 ms	5 s	80 ms	2 s	300 ms			

**Aufbau:**

Glasrohr, durchsichtig

Kontaktkappen:

Messing, vernickelt

Verpackungsmöglichkeiten:

100 St. = 10 x 10er Faltschachteln

500 St. / 1000 St. = Industrieverpackung (lose geschüttet in Faltkarton)

Als Baugruppe mit 2 Aufsteckkappen in beliebiger Form und Länge, fertig montiert

Construction:

Glasstube, transparent

Contact caps:

Brass, nickel plated

Packing opinions:

100 pcs. = 10 boxes of 10 pieces

500 pcs. / 1000 pcs. = Industrial box (loose in carton) As assembly with two pigtails in various forms and lengths, finally mounted

Bemessungswerte / Ratings

Art.-No.	Strom Current (A)	Spannung Voltage	Ausschaltvermögen Breaking capacity	Spannungsfall Voltage drop (Volt) max.	Max. Verlustleistung Max. power dissipation [W]	Schmelzintegral Melting integral [A ² Sec]
UL 632.305	63 mA	250 V	200 A	6,9	0,7	0,09
UL 632.306	80 mA	250 V	200 A	5,7	0,7	0,13
UL 632.307	100 mA	250 V	200 A	3,5	0,5	0,21
UL 632.308	125 mA	250 V	200 A	2,7	0,6	0,32
UL 632.309	160 mA	250 V	200 A	2,3	0,6	0,50
UL 632.310	200 mA	250 V	200 A	1,9	0,6	0,77
UL 632.311	250 mA	250 V	200 A	1,6	0,6	1,20
UL 632.312	300 mA	250 V	200 A	1,3	0,7	1,85
UL 632.334	375 mA	250 V	200 A	1,1	0,71	2,61
UL 632.314	500 mA	250 V	200 A	0,9	0,75	4,43
UL 632.335	750 mA	250 V	200 A	0,67	0,83	8,7
UL 632.317	1 A	250 V	200 A	0,54	0,88	16,4
UL 632.318	1,25	250 V	200 A	0,5	0,9	25,4
UL 632.319	1,6 A	250 V	200 A	0,38	1,0	39
UL 632.320	2 A	250 V	200 A	0,32	1,0	61
UL 632.321	2,5 A	250 V	200 A	0,27	1,1	94
UL 632.360	3 A	250 V	200 A	0,22	1,1	146
UL 632.323	4 A	250 V	200 A	0,19	1,2	226
UL 632.324	5 A	250 V	200 A	0,16	1,3	349
UL 632.325	6 A	250 V	200 A	0,16	1,6	286
UL 632.361	7 A	250 V	200 A	0,16	1,8	372
UL 632.326	8 A	250 V	200 A	0,15	1,9	483
UL 632.327	10 A	125 V	10.000 A	0,14	2,3	817
UL 632.328	12 A	125 V	10.000 A	0,13	2,6	1277
UL 632.329	15 A	125 V	10.000 A	0,12	3,0	2123

Electrical Characteristics

Prüfstrom Testing current	Schmelzzeit / Blow Time	
	Minimum	Maximum
100 %	4 Hrs	N / A
135 %	N / A	1 Hr
200 %	5 sec	30 sec



Aufbau:

100mA – 800mA: Keramikrohr
1A – 10A: Keramikrohr, mit Löschmittel

Kontaktkappen:

Messing, vernickelt

Lötbarkeit: gemäß EN 60068-2-20

Verpackungsmöglichkeiten:

100 St. = 10 x 10er Faltschachteln
500 St. = Industrieverpackung (lose geschüttet in Faltkarton)

Als Baugruppe mit 2 Aufsteckkappen in beliebiger Form und Länge, fertig montiert

Construction:

100mA – 800mA: Ceramictube
1A – 10A: Ceramictube, with extinguishing agent

Contact caps:

Brass, nickel plated

Solderability: by EN 60068-2-20

Packing options:

100 pcs. = 10 boxes of 10 pieces
500 pcs. = Industrial box (loose in carton)
As assembly with two pigtails in various forms and lengths, finally mounted

Bemessungswerte / Ratings

Art.-No.	Strom Current	Spannung Voltage	Ausschaltvermögen Breaking capacity	Spannungsfall Voltage drop max [mV]	Verlustleistung power dissip. Max [W]	Schmelzintegral Melting integral [A ² s]
632.707	100 mA	500 V	1.000 A / 500 V~	2.500	1,6	0,036
632.708	125 mA	500 V	1.000 A / 500 V~	2.000	1,6	auf Anfrage / on request
632.709	160 mA	500 V	1.000 A / 500 V~	1.900	1,6	
632.710	200 mA	500 V	1.000 A / 500 V~	1.800	1,6	
632.711	250 mA	500 V	1.000 A / 500 V~	1.700	2,5	0,38
632.712	315 mA	500 V	1.000 A / 500 V~	1.100	2,5	0,67
632.713	400 mA	500 V	1.000 A / 500 V~	1.000	2,5	0,46
632.714	500 mA	500 V	1.000 A / 500 V~	800	2,5	1,49
632.715	630 mA	500 V	1.000 A / 500 V~	700	2,5	3,23
632.716	800 mA	500 V	1.000 A / 500 V~	600	2,5	5,52
632.717	1 A	500 V	1.000 A / 500 V~	500	2,5	
632.718	1,25 A	500 V	1.000 A / 500 V~	400	2,5	3,72
632.719	1,6 A	500 V	1.000 A / 500 V~	350	2,5	5,89
632.720	2 A	500 V	1.000 A / 500 V~	300	2,5	13,28
632.721	2,5 A	500 V	1.000 A / 500 V~	300	4	23,50
632.722	3,15 A	500 V	1.000 A / 500 V~	250	4	56,76
632.723	4 A	500 V	1.000 A / 500 V~	200	4	28,80
632.724	5A	500 V	1.000 A / 500 V~	150	4	44,00
632.725	6,3 A	500 V	1.000 A / 500 V~	150	4	150,03
632.726	8 A	500 V	1.000 A / 500 V~	150	4	207,36
632.727	10 A	500 V	1.000 A / 500 V~	150	4	378,00

Schmelzzeit-Grenzwert / Pre-arcing time limits

Bemessungsstrom Rated current	2,1 I _{rat} max.		2,75 I _{rat} min. max.		4 I _{rat} min. max.		10 I _{rat} max.	
	100 mA – 10 A	900 s		400 ms	20 s	100 ms	2 s	15 ms

G-Sicherungseinsätze

No. UL 632.700

Fuse-links

time-lag

6,3 x 32 mm

träge



ESKA

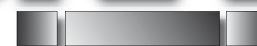

T
UL No. 248-14



Aufbau:

Keramikrohr

Kontaktkappen:

Messing, vernickelt

Verpackungsmöglichkeiten:

100 St. = 10 x 10er Faltschachteln

500 St./ 1000 St. = Industrieverpackung (lose geschützt in Faltkarton)

Als Baugruppe mit 2 Aufsteckkappen in beliebiger Form und Länge, fertig montiert

Construction:

Ceramic tube

Contact caps:

Brass, nickel plated

Packing opinions:

100 pcs. = 10 boxes of 10 pieces

500 pcs. / 1000 pcs. = Industrial box (loose in carton) As assembly with two pigtails in various forms and lengths, finally mounted

Bemessungswerte / Ratings

Art.-No.	Strom Current (A)	Spannung Voltage	Ausschaltvermögen Breaking capacity	Spannungsfall Voltage drop (Volt) max.	Max. Verlustleistung Max. power dissipation [W]	Schmelzintegral Melting integral [A ² S]
UL 632.705	63 mA	125 V	10.000 A	6,92	0,71	0,087
UL 632.706	80 mA	125 V	10.000 A	5,73	0,74	0,135
UL 632.707	100 mA	125 V	10.000 A	4,00	0,55	0,209
UL 632.708	125 mA	125 V	10.000 A	2,82	0,58	0,323
UL 632.709	160 mA	125 V	10.000 A	2,33	0,60	0,499
UL 632.710	200 mA	125 V	10.000 A	1,93	0,63	0,773
UL 632.711	250 mA	125 V	10.000 A	1,62	0,66	1,20
UL 632.712	300 mA	125 V	10.000 A	1,35	0,70	1,85
UL 632.734	375 mA	125 V	10.000 A	1,18	0,73	2,6
UL 632.714	500 mA	125 V	10.000 A	0,949	0,78	4,4
UL 632.715	600 mA	125 V	10.000 A	0,794	0,82	6,9
UL 632.716	700 mA	125 V	10.000 A	0,727	0,84	8,5
UL 632.735	750 mA	125 V	10.000 A	0,691	0,85	10
UL 632.717	1 A	125 V	10.000 A	0,557	0,91	16
UL 632.718	1,25 A	125 V	10.000 A	0,466	0,96	25
UL 632.719	1,6 A	125 V	10.000 A	0,390	1,01	39
UL 632.720	2 A	125 V	10.000 A	0,327	1,06	61
UL 632.721	2,5 A	125 V	10.000 A	0,274	1,12	94
UL 632.760	3 A	125 V	10.000 A	0,229	1,18	146
UL 632.723	4 A	125 V	10.000 A	0,192	1,24	226
UL 632.724	5 A	125 V	10.000 A	0,161	1,31	349
UL 632.725	6 A	125 V	10.000 A	0,163	1,61	286
UL 632.761	7 A	125 V	10.000 A	0,157	1,81	372
UL 632.726	8 A	125 V	10.000 A	0,150	1,95	483
UL 632.727	10 A	250 V	750 A	0,139	2,26	817
UL 632.728	12 A	250 V	750 A	0,129	2,56	1277
UL 632.729	15 A	250 V	750 A	0,120	2,96	2123

Electrical Characteristics

Prüfstrom Testing current	Schmelzzeit / Blow Time	
	Minimum	Maximum
100 %	4 Hrs	N / A
135 %	N / A	1 Hr
200 %	5 sec	30 sec

**Aufbau:**

Glasrohr, durchsichtig

Kontaktkappen:

Messing, vernickelt

Lötbarkeit: gemäß EN 60068-2-20**Verpackungsmöglichkeiten:**

100 St. = 10 x 10er Faltschachteln

500 St. = Industrieverpackung (lose geschüttet in Faltkarton)

Als Baugruppe mit 2 Aufsteckkappen in beliebiger Form und Länge, fertig montiert

Construction:

Glasstube, transparent

Contact caps:

Brass, nickel plated

Solderability: by EN 60068-2-20**Packing options:**

100 pcs. = 10 boxes of 10 pieces

500 pcs. = Industrial box (loose in carton)

As assembly with two pigtails in various forms and lengths, finally mounted

Bemessungswerte / Ratings

Art.-No.	Strom Current	Spannung Voltage	Ausschaltvermögen Breaking capacity	Spannungsfall Voltage drop max [mV]	Verlustleistung power dissip. Max [W]	Schmelzintegral Melting integral [A ² s]
632.904	50 mA	500 V	35 A / 500 V~	4.000	1,6	
632.905	63 mA	500 V	35 A / 500 V~	3.500	1,6	
632.906	80 mA	500 V	35 A / 500 V~	3.000	1,6	
632.907	100 mA	500 V	35 A / 500 V~	2.500	1,6	
632.908	125 mA	500 V	35 A / 500 V~	2.000	1,6	
632.909	160 mA	500 V	35 A / 500 V~	1.900	1,6	
632.910	200 mA	500 V	35 A / 500 V~	1.500	1,6	
632.911	250 mA	500 V	35 A / 500 V~	1.300	2,5	auf Anfrage / on request
632.912	315 mA	500 V	35 A / 500 V~	1.100	2,5	
632.913	400 mA	500 V	35 A / 500 V~	1.000	2,5	
632.914	500 mA	500 V	35 A / 500 V~	800	2,5	
632.915	630 mA	500 V	35 A / 500 V~	600	2,5	
632.916	800 mA	500 V	35 A / 500 V~	400	2,5	
632.917	1 A	500 V	35 A / 500 V~	300	2,5	
632.918	1,25 A	500 V	35 A / 500 V~	250	2,5	
632.919	1,6 A	500 V	35 A / 500 V~	200	2,5	
632.920	2 A	500 V	35 A / 500 V~	150	2,5	

Schmelzzeit-Grenzwert / Pre-arcing time limits

Bemessungsstrom Rated current	2,1 I _{rat} max.	min. 2,75 I _{rat} max.	min. 4 I _{rat} max.	min. 10 I _{rat} max.
50 mA – 2 A	600 s	400 ms 20 s	150 ms 2 s	20 ms 300 ms

**Aufbau: 8 x 40 mm nach DIN 41686**

32 mA - 125 mA: Glasrohr, durchsichtig

160 mA - 10 A: Glasrohr, mit Löschmittel

Kontaktkappen:

Messing, vernickelt

Verpackungsmöglichkeiten: 10 Stück je Einheit**Construction: 8x 40 mm at DIN 41686**

32 mA – 125 mA: Glasstube, transparent

160 mA – 10 A: Glasstube, with extinguishing agent

Contact caps:

Brass, nickel plated

Packing options: 10 pcs per unit**Bemessungswerte / Ratings**

Art.- No.	Strom Current	Spannung Voltage
556.000	32 mA – 10 A	500 V

**Aufbau: 8 x 50 mm nach DIN 41570**

32 mA - 125 mA: Glasrohr, durchsichtig

160 mA - 6,3 A: Glasrohr, mit Löschmittel

Kontaktkappen:

Messing, vernickelt

Verpackungsmöglichkeiten: 10 Stück je Einheit**Construction: 8x 50 mm at DIN 41570**

32 mA – 125 mA: Glasstube, transparent

160 mA – 6,3 A: Glasstube, with extinguishing agent

Contact caps:

Brass, nickel plated

Packing options: 10 pcs per unit**Bemessungswerte / Ratings**

Art.- No.	Strom Current	Spannung Voltage
557.000	32 mA – 6,3 A	1,2 kV

Hochspannungs- G –Sicherungshalter: Seite 125
High Voltage G – fuse holder: page 125

**Aufbau: 8 x 85 mm nach DIN 41569**

32 mA - 125 mA: Glasrohr, durchsichtig

160 mA - 4 A: Glasrohr, mit Löschmittel

Kontaktkappen:

Messing, vernickelt

Verpackungsmöglichkeiten: 10 Stück je Einheit**Construction: 8x 85 mm at DIN 41569**

32 mA - 125 mA: Glasstube, transparent

160 mA - 4 A: Glasstube, with extinguishing agent

Contact caps:

Brass, nickel plated

Packing opinions: 10 pcs. per unit**Bemessungswerte / Ratings**

Art.- No.	Strom Current	Spannung Voltage
558.000	32 mA - 4 A	3 kV

No. 559.000**8 x 120 mm**

Fuse-links

DIN 41683

**Aufbau: 8 x 120 mm nach DIN 41683**

Glasrohr, mit Löschmittel

Kontaktkappen:

Messing, vernickelt

Verpackungsmöglichkeiten: 10 Stück je Einheit**Construction: 8x 120 at DIN 41683**

Glasstube, with extinguishing agent

Contact caps:

Brass, nickel plated

Packing opinions: 10 pcs. per unit**Bemessungswerte / Ratings**

Art.- No.	Strom Current	Spannung Voltage
559.000	32 mA - 8 A	6 kV

No. 560.000**8 x 150 mm**

Fuse-links

DIN 41684

**Aufbau: 8 x 150 mm nach DIN 41684**

32 mA - 500 mA: Glasrohr, durchsichtig

630 mA - 2 A: Glasrohr, mit Löschmittel

Kontaktkappen:

Messing, vernickelt

Verpackungsmöglichkeiten: 10 Stück je Einheit**Construction: 8x 150 at DIN 41684**

32 mA - 500 mA: Glasstube, transparent

630 mA - 2 A: Glasstube, with extinguishing agent

Contact caps:

Brass, nickel plated

Packing opinions: 10 pcs. per unit**Bemessungswerte / Ratings**

Art.- No.	Strom Current	Spannung Voltage
560.000	32 mA - 2 A	10 kV

Hochspannungs- G -Sicherungshalter: 125 Seite
High Voltage G - fuse holder: 125 site



Verpackungsmöglichkeiten:
100 St. = 10 x 10er Faltschachteln

Packing opinions:
100 pcs. = 10 boxes of 10 pieces

Bemessungswerte / Ratings

Art.- No.	Strom Current	Spannung Voltage	Ausschaltvermögen Breaking capacity	Schmelzintegral [A ² s]	Verlustleistung power dissipation [W]
1038.118	1,25 A	660 V	160 kA	0,28	0,9
1038.119	1,5 A	660 V	160 kA	0,36	1,25
1038.120	2 A	660 V	160 kA	0,57	1,5
1038.121	2,5 A	660 V	160 kA	1,3	2
1038.122	3 A	660 V	160 kA	2,7	2,1
1038.123	4 A	660 V	160 kA	4,6	2,3
1038.124	5 A	660 V	160 kA	12	2,6
1038.125	6A	660 V	160 kA	25	2,7
1038.126	8 A	660 V	160 kA	44	2,9
1038.127	10 A	660 V	160 kA	33	2,4
1038.128	12,5 A	660 V	160 kA	55	3,4
1038.130	16 A	660 V	160 kA	82	3,4
1038.131	20 A	660 V	160 kA	145	4,1
1038.132	25 A	660 V	160 kA	250	4,3
1038.133	30 A	660 V	160 kA	470	4,7
1038.134	32 A	660 V	160 kA	740	5

**Verpackungsmöglichkeiten:**

100 St. = 10 x 10er Faltschachteln

Packing opinions:

100 pcs. = 10 boxes of 10 pieces

Bemessungswerte / Ratings

Art.-No.	Strom Current	Spannung Voltage	Ausschaltvermögen Breaking capacity	Max. Verlustleistung power dissipation [W]
1038.614	0,5 A	500 V	120 kA	1,43
1038.617	1 A	500 V / 690 V	120 kA	2,77
1038.620	2 A	500 V / 690 V	120 kA	0,60
1038.623	4 A	500 V / 690 V	120 kA	0,70
1038.625	6 A	500 V / 690 V	120 kA	0,85
1038.626	8 A	500 V / 690 V	120 kA	0,75
1038.627	10 A	500 V / 690 V	120 kA	1,00
1038.628	12 A	500 V / 690 V	120 kA	1,30
1038.630	16 A	500 V / 690 V	120 kA	1,60
1038.631	20 A	500 V	120 kA	2,00
1038.632	25 A	500 V	120 kA	2,60
1038.634	32 A	400 V	120 kA	2,90

**Verpackungsmöglichkeiten:**









100 St. = 10 x 10er Faltschachteln





Packing opinions:







100 pcs. = 10 boxes of 10 pieces

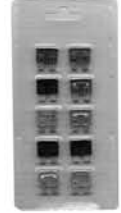

Bemessungswerte / Ratings

Art.- No.	Strom Current	Spannung Voltage	Ausschaltvermögen Breaking capacity	Max . Leistungsverlust power dissipation [W]
1038.314	0,5 A	500 V	120 kA	0,49
1038.317	1 A	500 V / 690 V	120 kA	0,10
1038.320	2 A	500 V / 690 V	120 kA	0,18
1038.323	4 A	500 V / 690 V	120 kA	0,31
1038.325	6 A	500 V / 690 V	120 kA	0,32
1038.326	8 A	500 V / 690 V	120 kA	0,52
1038.327	10 A	500 V / 690 V	120 kA	0,55
1038.328	12A	500 V / 690 V	120 kA	0,63
1038.330	16 A	500 V	120 kA	0,92
1038.331	20 A	500 V	120 kA	0,96
1038.332	25 A	500 V	120 kA	1,40
1038.334	32 A	400 V	120 kA	1,80

Bemessungswerte/ Ratings	Sortimentskästen / Assortment Boxes			
Produktfoto / product picture				
Typ / type	5 x 20 (100 St./pcs.)	5 x 20 (100 St./pcs.)	5 x 20 (200 St./pcs.)	5 x 20 (360 St./pcs.)
Merkmal / characteristic	F / M / T	F / T	F / M / T	F / M / T
Strom / current	160 mA – 6,3 A	160 mA – 5 A 160 mA – 6,3 A	100 mA – 6,3 A	100 mA – 6,3 A
Spannung / voltage	250 V	250 V	250 V	250 V
Norm	DIN41661/ EN60127-2-2 DIN 41571/2 DIN41662/ EN60127-2-3	DIN 41.660/ EN 60127-2-1 EN 60127-2-5	DIN41661/ EN60127-2-2 DIN 41571/2 DIN41662/ EN60127-2-3	DIN41661/ EN60127-2-2 DIN 41571/2 DIN41662/ EN60127-2-3
RoHS				
Katalogseite / catalogue page	52	52	52	52

Bemessungswerte/ Ratings	Sortimentskästen / Assortment Boxes	
Produktfoto / product picture		
Typ / type	6,3 x 32 (120 St./pcs.)	Kleinstsicherungssortiment (190 St./pcs.) Sub-Miniature Fuses Assortment Box
Merkmal / characteristic	F / M / T	F / T
Strom / current	315 mA – 10 A	100 mA – 6,3 A
Spannung / voltage	250 V	250 V
Norm		EN 60127-3-3 EN 60127-3-4
RoHS		
Katalogseite / catalogue page	53	53

Bemessungswerte/ Ratings	KFZ-Sicherungssortimente / Automobile Fuses Assortment Boxes		
Produktfoto / product picture			
Typ / type	UNIVAL (80 St./ pcs.)	MINIVAL (80 St./ pcs.)	UNIVAL (10 St./ pcs.) Blister
Merkmal / characteristic	U	M	U
Strom / current	4A – 30 A	2 A – 30 A	3 A – 30 A
Spannung / voltage	32 V	32 V	32 V
RoHS			
Katalogseite / catalogue page	54	54	54

Bemessungswerte/ Ratings	Temperatursicherungssortiment / Temperature Fuses Assortment Box
Produktfoto / product picture	
Typ / type	E4 Axial (180 St./ pcs.)
Bemessungstemperatur / calibration range °C	72 °C – 240 °C
Strom / current	10 A
Spannung / voltage	250 V
RoHS	
Katalogseite / catalogue page	55



Inhalt / contents: 100 St./ pcs
 10 x 160 mA
 10 x 250 mA
 10 x 500 mA
 10 x 630 mA
 10 x 800 mA
 10 x 1 A
 10 x 1,6 A
 10 x 2,5 A
 10 x 4 A
 10 x 6,3 A

5 x 20 mm
 F = (DIN 41661 / EN 60127-2-2)
 M = (DIN 41571/2)
 T = (DIN 41662 / EN 60127-2-3)

Bestell / Order Nr.:

F 120.900
M 121.800
T 122.800



Inhalt / contents: 100 St./ pcs

F	T
10 x 160 mA	10 x 160 mA
10 x 250 mA	10 x 250 mA
20 x 500 mA	20 x 500 mA
10 x 800 mA	10 x 800 mA
10 x 1 A	10 x 1,25 mA
10 x 1,6 A	10 x 1,6 A
10 x 2,5 A	10 x 2,5 A
10 x 4 A	10 x 4 A
10 x 5 A	10 x 6,3 A

5 x 20 mm
 F = (DIN 41.660 / EN 60127-2-1)
 T = (EN 60127-2-5)

Bestell / Order Nr.:

F 120.950
T 122.850



Inhalt / contents: 200 St./ pcs

10 x 100 mA	30 x 1 A
10 x 200 mA	10 x 1,25 A
10 x 315 mA	20 x 1,6 A
10 x 400 mA	10 x 2,5 A
30 x 500 mA	10 x 4 A
20 x 630 mA	10 x 6,3 A
20 x 800 mA	

5 x 20 mm
 F = (DIN 41661 / EN 60127-2-2)
 M = (DIN 41571/2)
 T = (DIN 41662 / EN 60127-2-3)

Bestell / Order Nr.:

F 520.800
M 521.800
T 522.800



Inhalt / contents: 360 St./ pcs

20 x 100 mA	20 x 1 A
20 x 125 mA	20 x 1,25 A
20 x 160 mA	20 x 1,6 A
20 x 200 mA	20 x 2 A
20 x 250 mA	20 x 2,5 A
20 x 315 mA	20 x 3,15 A
20 x 400 mA	20 x 4 A
20 x 500 mA	20 x 6,3 A
20 x 630 mA	
20 x 800 mA	

5 x 20 mm
 F = (DIN 41661 / EN 60127-2-2)
 M = (DIN 41571/2)
 T = (DIN 41662 / EN 60127-2-3)

Bestell / Order Nr.:

F E3520.800
M E3521.800
T E3522.800



Inhalt / contents: 120 St./ pcs.
 10 x 315 mA
 10 x 500 mA
 10 x 800 mA
 10 x 1 A
 10 x 1,25 A
 10 x 1,6 A
 10 x 2 A
 10 x 2,5 A
 10 x 4 A
 10 x 5 A
 10 x 6,3 A
 10 x 10 A

6,3 x 32 mm

Bestell / Order Nr.:

F 632.800
M 632.820
T 632.830



Inhalt / contents: 190 St./ pcs
 10 x 100 mA
 10 x 125 mA
 10 x 160 mA
 10 x 200 mA
 10 x 250 mA
 10 x 315 mA
 10 x 400 mA
 10 x 500 mA
 10 x 630 mA
 10 x 800 mA
 10 x 1 A
 10 x 1,25 A
 10 x 1,6 A
 10 x 2 A
 10 x 2,5 A
 10 x 3,15 A
 10 x 4 A
 10 x 5 A
 10 x 6,3 A
 10 x Halter/ holder

Kleinstsicherungssortiment
Subminiature fuses assortment box
 F = EN 60127-3-3
 T = EN 60127-3-4

Bestell / Order Nr.:

F 885.800
T 887.800

T 883.800 rechteckiger Körper
 rectangular body



**Inhalt /contents: UNIVAL 80 St. /pcs.
(160 St. /pcs.)**

10 x 4 A
10 x 5 A
10 x 7,5 A
10 x 10 A
10 x 15 A
10 x 20 A
10 x 25 A
10 x 30 A

**KFZ-Sicherungs assortimente
Automobile fuses assortment box**
DIN 72581/3C ISO 8820-3
Spannung / Voltage: 32 V

**Bestell / Order Nr.:
U 340.800**



Inhalt/contents:MINIVAL 80 St. /pcs.

10 x 2 A
3 x 3 A
10 x 4 A
3 x 5 A
10 x 7,5 A
10 x 10 A
10 x 15 A
10 x 20 A
4 x 25 A
10 x 30 A

**KFZ-Sicherungs assortimente
Automobile fuses assortment box**
ISO 8820-3
Spannung / Voltage: 32 V

**Bestell / Order Nr.:
M 340.850**



Inhalt/contents:UNIVAL 10 St. /pcs.

1 x 3 A
1 x 5 A
1 x 7,5 A
2 x 10 A
1 x 15 A
2 x 20 A
1 x 25 A
1 x 30 A

**Blister - Sicherungs assortimente
Blister - fuses assortment box**
DIN 72581/3C ISO 8820-3
Spannung / Voltage: 32 V

**Bestell / Order Nr.:
U 340.900**

Weitere Informationen und Varianten entnehmen Sie bitte dem Sonderkatalog "Automotive".
For further information and items please take a look in our extra catalogue "Automotive".

Temperatursicherungssortimente

Thermal cutoffs Assortment Boxes



Inhalt /contents: 90 St. /pcs.

5 x 72 °C	5 x 144 °C
5 x 77 °C	5 x 152 °C
5 x 84 °C	5 x 167 °C
5 x 93 °C	5 x 184 °C
5 x 98 °C	5 x 192 °C
5 x 104 °C	5 x 216 °C
5 x 110 °C	5 x 229 °C
5 x 117 °C	5 x 240 °C
5 x 121 °C	10 x Isolierschlauch
5 x 128 °C	20 x Quetschverbinder

Temperatursicherungssortiment

Temperature fuses assortment box

Ⓛ E40667 Ⓢ 062037 ⚠ 93820

Spannung / Voltage: 250 V

Strom / Current: 10A

Bestell / Order Nr.:

TCO.90.10A

Typ E4 Axial



Inhalt /contents: 180 St. /pcs.

10 x 72 °C	10 x 144 °C
10 x 77 °C	10 x 152 °C
10 x 84 °C	10 x 167 °C
10 x 93 °C	10 x 184 °C
10 x 98 °C	10 x 192 °C
10 x 104 °C	10 x 216 °C
10 x 110 °C	10 x 229 °C
10 x 117 °C	10 x 240 °C
10 x 121 °C	10 x Isolierschlauch
10 x 128 °C	20 x Quetschverbinder

Temperatursicherungssortiment

Temperature fuses assortment box

Ⓛ E40667 Ⓢ 062037 ⚠ 93820

Spannung / Voltage: 250 V

Strom / Current: 10A







Bestell / Order Nr.:

TCO.180.10A

Typ E4 Axial

Bemessungswerte/ Ratings	Kleinstsicherungen / Subminiature Fuse			
Produktfoto / product picture				
Typ / type	Picofuse 823.600	Picofuse 888.300	Picofuse 888.200	Picofuse ES-MQ
Merkmal / characteristic	F	F	T	F
Strom / current	63 mA – 15 A	500 mA – 10 A	1 A – 6,3 A	100 mA – 15 A
Spannung / voltage	125 V	250 V	250 V	125 V
Ausschaltvermögen / breaking capacity	300 A	35 A	35 A	50 A
Prüfzeichen / approvals				
Norm	EN 60127-3-2		EN 60127-3-4	
Katalogseite / catalogue page	58	59	60	61

Bemessungswerte/ Ratings	Kleinstsicherungen / Subminiature Fuse		
Produktfoto / product picture			
Typ / type	Picofuse ES-MS	UMF 900.000	UMF 910.000
Merkmal / characteristic	T	F	T
Strom / current	250 mA – 7 A	160 mA – 6,3 A	80 mA – 2 A
Spannung / voltage	125 V	250 V	250 V
Ausschaltvermögen / breaking capacity	50 A	35 A	35 A
Prüfzeichen / approvals			
Norm		EN 60127-4-1	EN 60127-4-1
Katalogseite / catalogue page	62	63	64

Bemessungswerte/ Ratings	Kleinstsicherungen / Subminiature Fuse		
Produktfoto / product picture			
Typ / type	885.000	887.000	883.000
Merkmal / characteristic	F	T	T
Strom / current	50 mA – 6,3 A	80mA – 6,3 A	80 mA – 6,3 A
Spannung / voltage	250 V	250 V	250 V
Ausschaltvermögen / breaking capacity	35 A	35 A	35 A
Prüfzeichen / approvals			
UL file-no. VDE no.		E 163905 VDE 40016747 VDE 40016749	E 163905 VDE 40016839
Norm	60127-3-3	60127-3-4	60127-3-4
Katalogseite / catalogue page	65	66	67

Verpackungsmöglichkeiten:

Ampopack: 5.000 St. in der Schachtel

Packing opinions:

Ammo pack: 5.000 pcs. per inner box



Bemessungswerte / Ratings

Art.-No.	Strom Current	Spannung Voltage	Ausschaltvermögen Breaking capacity	Spannungsfall Voltage drop max [mV]	Schmelzintegral Melting integral [A ² s]
823.605	63 mA	125 V	300 A	2.230	0,0002
823.608	125 mA	125 V	300 A	1.500	0,0010
823.611	250 mA	125 V	300 A	1.000	0,0070
823.650 ¹⁾	315 mA	125 V	300 A	1.000	0,0065
823.612 ²⁾	375 mA	125 V	300 A	1.000	0,0060
823.613 ¹⁾	400 mA	125 V	300 A	1.000	0,0110
823.614	500 mA	125 V	300 A	1.000	0,0180
823.615 ¹⁾	630 mA	125 V	300 A	500	0,0230
823.616 ²⁾	750 mA	125 V	300 A	275	0,0400
823.655 ¹⁾	800 mA	125 V	300 A	275	0,0420
823.617	1 A	125 V	300 A	275	0,0940
823.618 ¹⁾	1,25 A	125 V	300 A	275	0,1380
823.619 ²⁾	1,5 A	125 V	300 A	275	0,3300
823.659 ¹⁾	1,6 A	125 V	300 A	275	0,4330
823.620	2 A	125 V	300 A	250	0,4100
823.621	2,5 A	125 V	300 A	250	0,8200
823.622 ²⁾	3 A	125 V	300 A	250	1,5000
823.664 ¹⁾	3,15 A	125 V	300 A	250	1,2900
823.665 ²⁾	3,5 A	125 V	300 A	250	1,800
823.623	4 A	125 V	300 A	225	3,2000
823.624	5 A	125 V	300 A	225	4,1000
823.626 ²⁾	7 A	125 V	300 A	150	11,000
823.627 ¹⁾²⁾	10 A	125 V	50 A	125	30,000
823.628 ¹⁾²⁾	12 A	32 V	50 A	100	auf Anfrage / on request
823.629 ¹⁾²⁾	15 A	32 V	50 A	100	on request

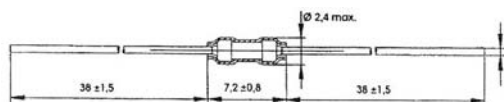

Schmelzeit-Grenzwert / Pre-arcing time limits

Bemessungsstrom Rated current	1 I _{rat} min.	2 I _{rat} max.	2,75 I _{rat} max.	4 I _{rat} max.	10 I _{rat} max.
63 mA – 10 A 12 A - 15 A 63 mA – 10 A		5 s 10 s	300 ms	30 ms	4 ms

1) kein UL/cUL - no UL/cUL approval

2) kein CCC – no CCC approval



Verpackungsmöglichkeiten:

Ammopack 2.000 St. in der Schachtel
Ammopack 25.000 St in der Schachtel

Packing opinions:

Ammo pack 2.000 pcs. per inner box
Ammo pack 25.000 pcs per inner box.

Bemessungswerte / Ratings

Art.-No.	Strom Current	Spannung Voltage	Ausschaltvermögen Breaking capacity	Spannungsfall Voltage drop max [mV]	Schmelzintegral Melting integral [A ² s]
888.314	500 mA	250 V	35 A	350	0,078
888.315	630 mA	250 V	35 A	320	0,159
888.316	800 mA	250 V	35 A	300	0,230
888.317	1 A	250 V	35 A	280	0,340
888.318	1,25 A	250 V	35 A	280	0,844
888.319	1,6 A	250 V	35 A	250	1,280
888.320	2 A	250 V	35 A	240	2,760
888.321	2,5 A	250 V	35 A	200	3,813
888.322	3,15 A	250 V	35 A	180	4,961
888.323	4 A	250 V	35 A	160	8,800
888.324	5 A	250 V	35 A	150	12,750
888.325	6,3 A	250 V	35 A	150	26,195
888.327	10 A	250 V	35 A	150	103,000

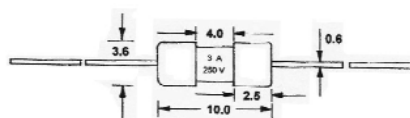

Schmelzeit-Grenzwert / Pre-arcing time limits

Bemessungsstrom Rated current	1,5 I _{rat} min..	2,1 I _{rat} max.	2,75 I _{rat} min. max.	4 I _{rat} min. max.	10 I _{rat} Max.
500 mA – 10 A	1 h	30 min.	10 ms 3 s	3 ms 300 ms	20 ms



Verpackungsmöglichkeiten:

Ammopack 2.000 St. in der Schachtel
Ammopack 25.000 St in der Schachtel

Packing opinions:

Ammo pack 2.000 pcs. per inner box
Ammo pack 25.000 pcs per inner box.

Bemessungswerte / Ratings

Art.-No.	Strom Current	Spannung Voltage	Ausschaltvermögen Breaking capacity	Spannungsfall Voltage drop max [mV]	Schmelzintegral Melting integral [A ² s]
888.217	1 A	250 V	35 A	140	3,00
888.218	1,25 A	250 V	35 A	130	5,70
888.219	1,6 A	250 V	35 A	120	6,90
888.220	2 A	250 V	35 A	100	18,4
888.221	2,5 A	250 V	35 A	100	23,50
888.222	3,15 A	250 V	35 A	100	31,20
888.223 ¹⁾	4 A	250 V	35 A	100	65,4
888.224 ¹⁾	5 A	250 V	35 A	100	110,0
888.225 ¹⁾	6,3 A	250 V	35 A	100	179,0

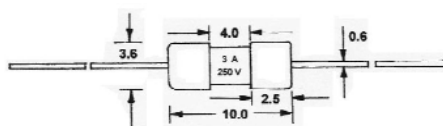

Schmelzeit-Grenzwert / Pre-arcing time limits

Bemessungsstrom Rated current	1,5 I _{rat} min..		2,1 I _{rat} max.		2,75 I _{rat} min. max.		4 I _{rat} min. max.		10 I _{rat} min. max.	
	1 A – 6,3 A	1 h		2 min.		400 ms	10 s	150 ms	3 s	20 ms

1) UR/cUR und VDE beantragt / applied



Verpackungsmöglichkeiten:
2.500 St. gegurtet auf Rolle
1.000 St. = Industrieverpackung
(lose geschüttet in Faltkarton)

Packing options:
2.500 pcs. taped per reel
1.000 pcs. = Industrial box
(loose in carton)

Technische Spezifikation / Technical Specification:

Schock /Schock Resistance:
MIL-STD-202G, Method 213B, Test Condition I
Vibration /Vibration Resistance:
MIL – STD-202G, Method 201
Salznebel /Salt Spray:
MIL-STD-202, Method 101,
Test condition B (48 hrs)
Lötbarkeit /Solderability:
MIL-STD-202G, Method 208 H
**Wärmebeständigkeit beim Löten /
Soldering Heat Resistance:**
MIL-STD-202F Method 210 E, Test Condition C
Temperaturbereich / Operating Temperature:
-55 °C to 125 °C



Bemessungswerte / Ratings

Art.- No.	Strom Current (A)	Spannung Voltage	Ausschaltvermögen Breaking capacity	Spannungsfall Voltage drop (Volt) max.	Max. Verlustleistung Max. power dissipation [W]	Schmelzintegral Melting integral [A ² S]
ES-MQ100	100 mA	125 V	50 A	3,00	0,350	0,0007
ES-MQ125	125 mA	125 V	50 A	0,61	0,087	0,0012
ES-MQ150	150 mA	125 V	50 A	0,54	0,10	0,0019
ES-MQ200	200 mA	125 V	50 A	0,48	0,12	0,003
ES-MQ250	250 mA	125 V	50 A	0,43	0,14	0,005
ES-MQ300	300 mA	125 V	50 A	0,39	0,16	0,009
ES-MQ375	375 mA	125 V	50 A	0,35	0,18	0,013
ES-MQ500	500 mA	125 V	50 A	0,31	0,21	0,025
ES-MQ750	750 mA	125 V	50 A	0,25	0,27	0,062
ES-MQ 1	1 A	125 V	50 A	0,22	0,33	0,11
ES-MQ 1,5	1,5 A	125 V	50 A	0,18	0,42	0,29
ES-MQ 2	2 A	125 V	50 A	0,24	0,33	0,33
ES-MQ 2,5	2,5 A	125 V	50 A	0,22	0,40	0,59
ES-MQ 3	3 A	125 V	50 A	0,21	0,48	1,1
ES-MQ 3,5	3,5 A	125 V	50 A	0,20	0,53	1,4
ES-MQ 4	4 A	125 V	50 A	0,19	0,58	1,9
ES-MQ 5	5 A	125 V	50 A	0,17	0,71	3,4
ES-MQ 7	7 A	125 V	50 A	0,15	0,90	8
ES-MQ 10	10 A	125 V	50 A	0,098	1,30	25
ES-MQ 12	12 A	125 V	50 A	0,093	1,50	41
ES-MQ 15	15 A	125 V	50 A	0,088	1,80	70

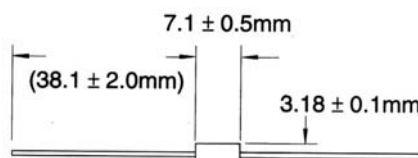

Prüfstrom Testing current	Schmelzzeit/ Blow Time	
	min	max
100 %	4 h	N / A
200 %	N / A	5 s



Verpackungsmöglichkeiten:
2.500 St. gegurtet auf Rolle
1.000 St.. = Industrieverpackung
(lose geschüttet in Faltpapier)

Packing options:
2.500 pcs. per reel
1.000 pcs. = Industrial box
(loose in carton)

**Technische Spezifikation /
Technical Spezification:**

Schock / Shock Resistance:
MIL-STD-202G, Method 213, Test Condition I
Vibration / Vibration Resistance:
MIL – STD-202G, Method 201
Salznebel / Salt Spray:
MIL-STD-202, Method 101,
Test condition B (48 hrs)
Lötbarkeit / Solderability:
MIL-STD-202G, Method 208 H
**Wärmebeständigkeit beim Löten /
Soldering Heat Resistance:**
MIL-STD-202F Method 210 E, Test Condition C
Temperaturbereich / Operating Temperature:
-55 °C to 125 °C

Bemessungswerte / Ratings

Art.- No.	Strom Current (A)	Spannung Voltage	Ausschaltvermögen Breaking capacity	Spannungsfall Voltage drop (Volt) max.	Max. Verlustleistung Max. power dissipation [W]	Schmelzintegral Melting integral [A ² S]
ES-MS250	250 mA	125 V	50 A	2,20	0,80	0,047
ES-MS300	300 mA	125 V	50 A	2,02	0,82	0,063
ES-MS375	375 mA	125 V	50 A	1,69	0,85	0,111
ES-MS500	500 mA	125 V	50 A	1,42	0,88	0,20
ES-MS750	750 mA	125 V	50 A	1,09	0,94	0,46
ES-MS 1	1 A	125 V	50 A	0,91	0,98	0,81
ES-MS1,25	1,25 A	125 V	50 A	0,77	1,01	1,44
ES-MS 1,5	1,5 A	125 V	50 A	0,70	1,03	1,9
ES-MS 2	2 A	125 V	50 A	0,59	1,08	3,4
ES-MS 2,5	2,5 A	125 V	50 A	0,50	1,12	6,0
ES-MS 3	3 A	125 V	50 A	0,45	1,14	8,0
ES-MS 3,5	3,5 A	125 V	50 A	0,42	1,17	10,6
ES-MS 4	4 A	125 V	50 A	0,38	1,19	14
ES-MS 5	5 A	125 V	50 A	0,29	1,26	33
ES-MS 7	7 A	125 V	50 A	0,25	1,31	59

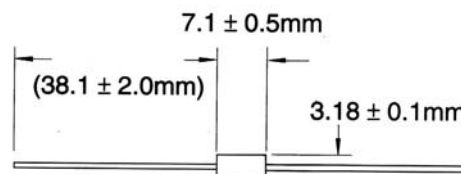

Prüfstrom Testing current	Schmelzzeit/ Blow Time	
	min	max
100 %	4 h	N / A
200 %	N / A	30 s



Aufbau:

Temperaturbeständiges Thermoplast -
kunststoffgehäuse

Anschlußstifte:

Rundstifte, Abstand 7,54 mm
Oberfläche verzinkt, steckbar und lötbar

Verpackungsmöglichkeiten:

1.000 St. = Industrieverpackung
1.000 St. = Ammopack

Construction:

Temperature resistant thermoplastic body

Connection pins:

Round pins, distance 7,54 mm
surface tin - plated, pluggable and solderable

Packing opinions:

1.000 pcs. = Industrial box
1.000 pcs. = Ammo pack

Bemessungswerte / Ratings

Art.- No.	Strom Current	Spannung Voltage	Ausschaltvermögen Breaking capacity	Spannungsfall Voltage drop [mV] max.	Schmelzintegral Melting integral [A ² S]
900.009	160 mA	250 V	35 A	1.000	
900.010	200 mA	250 V	35 A	1.000	
900.011	250 mA	250 V	35 A	800	
900.012	315 mA	250 V	35 A	750	
900.013	400 mA	250 V	35 A	700	
900.014	500 mA	250 V	35 A	600	
900.015	630 mA	250 V	35 A	500	
900.016	800 mA	250 V	35 A	400	auf Anfrage/ on request
900.017	1 A	250 V	35 A	300	
900.018	1,25 A	250 V	35 A	300	
900.019	1,6 A	250 V	35 A	300	
900.020	2 A	250 V	35 A	300	
900.021	2,5 A	250 V	35 A	300	
900.022	3,15 A	250 V	35 A	300	
900.023	4 A	250 V	40 A	300	
900.024	5 A	250 V	50 A	300	
900.025	6,3 A	250 V	63 A	300	

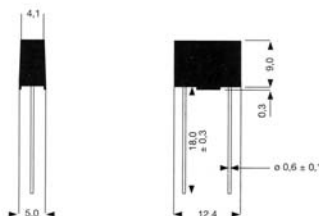

Schmelzeit-Grenzwert / Pre-arcing time limits

Bemessungsstrom Rated current	1,25 I _{rat} min.	2 I _{rat} max.	min	10 I _{rat} max.
160 mA – 6,3 A	1 h	2 min.	0,001 s	0,01 s



Aufbau:

Temperaturbeständiges Thermoplast -
kunststoffgehäuse

Anschlußstifte:

Rundstifte, Abstand 7,54 mm
Oberfläche verzinnt, steckbar und lötlbar

Verpackungsmöglichkeiten:

1.000 Stk. = Industrieverpackung

1.000 Stk. = Ammopack

Construction:

Temperature resistant thermoplastic body

Connection pins:

Round pins, distance 7,54 mm
surface tin – plated, pluggable and solderable

Packing opinions:

1.000 pcs = Industrial box

1.000 pcs = Ammo pack

Bemessungswerte / Ratings

Art.- No.	Strom Current	Spannung Voltage	Ausschaltvermögen Breaking capacity	Spannungsfall Voltage drop [mV] max.	Schmelzintegral Melting integral [A ² S]
910.006	80 mA	250 V	35 A		
910.007	100 mA	250 V	35 A	1.300	
910.008	125 mA	250 V	35 A	1.000	
910.009	160 mA	250 V	35 A	1.000	
910.010	200 mA	250 V	35 A	1.000	
910.011	250 mA	250 V	35 A	800	
910.012	315 mA	250 V	35 A	750	
910.013	400 mA	250 V	35 A	700	auf Anfrage/ on request
910.014	500 mA	250 V	35 A	600	
910.015	630 mA	250 V	35 A	500	
910.016	800 mA	250 V	35 A	400	
910.017	1 A	250 V	35 A	300	
910.018	1,25 A	250 V	35 A	300	
910.019	1,6 A	250 V	35 A	300	
910.020	2 A	250 V	35 A	300	

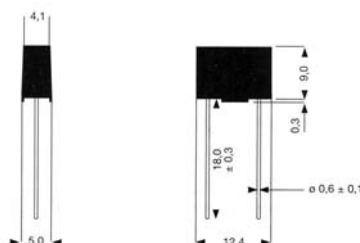

Schmelzeit-Grenzwert / Pre-arcing time limits

Bemessungstrom Rated current	1,25 I _{rat} min.	2 I _{rat} max.	min	10 I _{rat} max.
80 mA – 2 A	1 h	2 min.	0,01 s	0,1 ms



Aufbau:

Temperaturbeständiges Thermoplast - kunststoffgehäuse

Anschlußstifte:

Rundstifte, Abstand 5,08 mm

Oberfläche verzinkt, steckbar und lötbar

Verpackungsmöglichkeiten:

1.000 Stk. = Industrieverpackung

1.000 Stk. = Ampopack, z.B. 885.017G

Construction:

Temperature resistant thermoplastic body

Connection pins:

Round pins, distance 5,08 mm

surface tin - plated, pluggable and solderable

Packing opinions:

1.000 pcs = Industrial box

1.000 pcs = Ammo pack, e.g. 885.017G

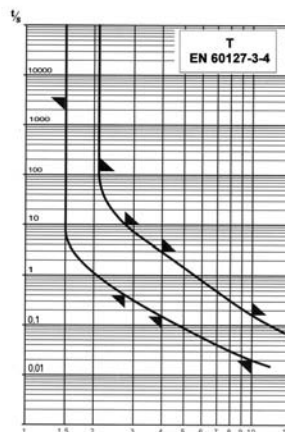

Bemessungswerte / Ratings

Art.- No.	Strom Current	Spannung Voltage	Ausschaltvermögen Breaking capacity	Spannungsfall Voltage drop (Volt) max.	Max. Verlustleistung Max. power dissipation [W]	Schmelzintegral Melting integral [A ² S]
885.004	50 mA	250 V	35 A	0,72	0,08	0,001
885.005	63 mA	250 V	35 A	0,65	0,09	0,001
885.006	80 mA	250 V	35 A	0,58	0,11	0,002
885.007	100 mA	250 V	35 A	0,52	0,12	0,003
885.008	125 mA	250 V	35 A	0,47	0,14	0,006
885.009	160 mA	250 V	35 A	0,27	0,10	0,010
885.010	200 mA	250 V	35 A	0,262	0,12	0,016
885.011	250 mA	250 V	35 A	0,254	0,15	0,027
885.012	315 mA	250 V	35 A	0,246	0,18	0,05
885.013	400 mA	250 V	35 A	0,239	0,22	0,08
885.014	500 mA	250 V	35 A	0,232	0,27	0,13
885.015	630 mA	250 V	35 A	0,106	0,15	0,13
885.016	800 mA	250 V	35 A	0,103	0,19	0,22
885.017	1 A	250 V	35 A	0,100	0,23	0,36
885.018	1,25 A	250 V	35 A	0,097	0,28	0,59
885.019	1,6 A	250 V	35 A	0,094	0,35	1,0
885.020	2 A	250 V	35 A	0,091	0,42	1,7
885.021	2,5 A	250 V	35 A	0,088	0,51	2,7
885.022	3,15 A	250 V	35 A	0,086	0,62	4,5
885.023	4 A	250 V	40 A	0,083	0,77	8,0
885.024	5 A	250 V	50 A	0,081	0,93	13,0
885.025	6,3 A	250 V	63 A	0,078	1,14	21,0

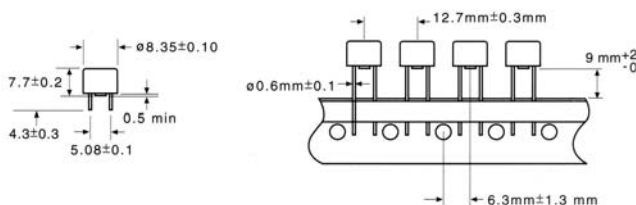

Schmelzeit-Grenzwert / Pre-arcing time limits

Bemessungsstrom Rated current	1,5 I _{rat} min.	2,1 I _{rat} max.	2,75 I _{rat} min. max.	4 I _{rat} min. max.	10 I _{rat} max.
50 mA – 6,3 A	1 h	30 min.	10 ms 3 s	3 ms 300 ms	20 ms



Aufbau:

Temperaturbeständiges Thermoplast -
kunststoffgehäuse

Anschlußstifte:

Rundstifte, Abstand 5,08 mm
Oberfläche verzinkt, steckbar und lötlbar

Verpackungsmöglichkeiten:

1.000 Stk. = Industrieverpackung
1.000 Stk. = Ammopack, z.B. 887.017G

Construction:

Temperature resistant thermoplastic body

Connection pins:

Round pins, distance 5,08 mm
surface tin – plated, pluggable and solderable

Packing opinions:

1.000 pcs = Industrial box
1.000 pcs = Ammo pack, e.g. 887.017G

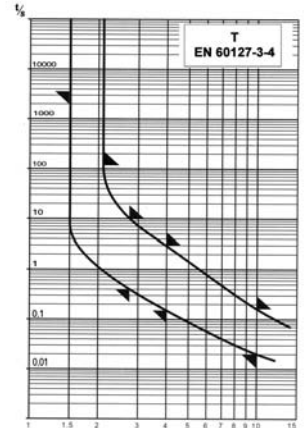

Bemessungswerte / Ratings

Art.- No.	Strom Current	Spannung Voltage	Ausschaltvermögen Breaking capacity	Spannungsfall Voltage drop @ 100 % /n (Volt) max.	Max. Verlustleistung Max. power dissipation [W]	Schmelzintegral Melting integral [A ² S]
887.006	80 mA	250 V	35 A	0,40	0,10	0,01
887.007	100 mA	250 V	35 A	0,35	0,11	0,02
887.008	125 mA	250 V	35 A	0,30	0,13	0,04
887.009	160 mA	250 V	35 A	0,26	0,15	0,06
887.010	200 mA	250 V	35 A	0,23	0,17	0,11
887.011	250 mA	250 V	35 A	0,22	0,19	0,41
887.012	315 mA	250 V	35 A	0,19	0,22	0,66
887.013	400 mA	250 V	35 A	0,16	0,25	1,0
887.014	500 mA	250 V	35 A	0,15	0,29	1,7
887.015	630 mA	250 V	35 A	0,13	0,33	2,6
887.016	800 mA	250 V	35 A	0,12	0,38	4,2
887.017	1 A	250 V	35 A	0,11	0,44	6,7
887.018	1,25 A	250 V	35 A	0,10	0,51	11,0
887.019	1,6 A	250 V	35 A	0,095	0,58	17,0
887.020	2 A	250 V	35 A	0,090	0,67	27,0
887.021	2,5 A	250 V	35 A	0,087	0,77	43,0
887.022	3,15 A	250 V	35 A	0,083	0,88	69,0
887.023	4 A	250 V	40 A	0,080	1,02	110,0
887.024	5 A	250 V	50 A	0,077	1,17	175,0
887.025	6,3 A	250 V	63 A	0,073	1,34	281,0

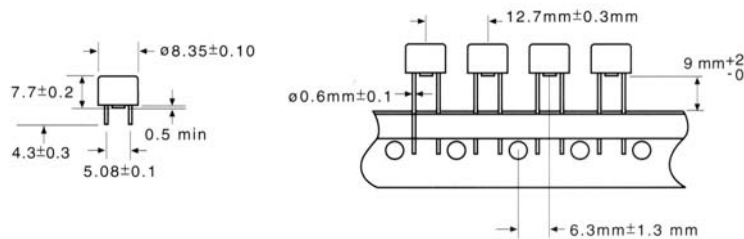

Schmelzeit-Grenzwert / Pre-arcing time limits

Bemessungsstrom Rated current	1,5 I _{rat}		2,1 I _{rat}		2,75 I _{rat}		4 I _{rat}		10 I _{rat}	
	min.	max.	min.	max.	min.	max.	min.	max.	min.	max.
80 mA – 6,3 A	1 h		2 min.		400 ms	10 s	150 ms	3 s	20 ms	150 ms



Aufbau:

Temperaturbeständiges Thermoplast -
kunststoffgehäuse

Anschlußstifte:

Rundstifte, Abstand 5,08 mm
Oberfläche verzinkt, steckbar und lötlbar

Verpackungsmöglichkeiten:

1.000 Stk. = Industrieverpackung
1.000 Stk. = Ammopack, z.B. 883.017G

Construction:

Temperature resistant thermoplastic body

Connection pins:

Round pins, distance 5,08 mm
surface tin - plated, pluggable and solderable

Packing opinions:

1.000 pcs = Industrial box
1.000 pcs = Ammo pack, 883.017G

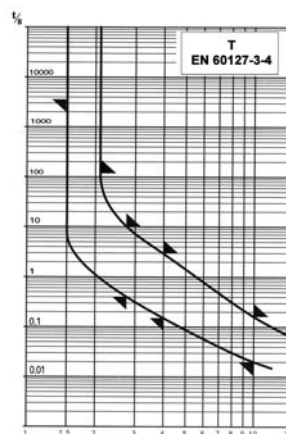

Bemessungswerte / Ratings

Art.- No.	Strom Current	Spannung Voltage	Ausschaltvermögen Breaking capacity	Spannungsfall Voltage drop @ 100 % /n (Volt) max.	Max. Verlustleistung Max. power dissipation [W]	Schmelzintegral Melting integral [A ² S]
883.006	80 mA	250 V	35 A	0,40	0,10	0,01
883.007	100 mA	250 V	35 A	0,35	0,11	0,02
883.008	125 mA	250 V	35 A	0,30	0,13	0,04
883.009	160 mA	250 V	35 A	0,26	0,15	0,06
883.010	200 mA	250 V	35 A	0,23	0,17	0,11
883.011	250 mA	250 V	35 A	0,22	0,19	0,41
883.012	315 mA	250 V	35 A	0,19	0,22	0,66
883.013	400 mA	250 V	35 A	0,16	0,25	1,00
883.014	500 mA	250 V	35 A	0,15	0,29	1,70
883.015	630 mA	250 V	35 A	0,13	0,33	2,60
883.016	800 mA	250 V	35 A	0,12	0,38	4,20
883.017	1 A	250 V	35 A	0,11	0,44	6,70
883.018	1,25 A	250 V	35 A	0,10	0,51	10,70
883.019	1,6 A	250 V	35 A	0,10	0,58	17,0
883.020	2 A	250 V	35 A	0,090	0,67	27,0
883.021	2,5 A	250 V	35 A	0,087	0,77	43,0
883.022	3,15 A	250 V	35 A	0,083	0,88	69,0
883.023	4 A	250 V	40 A	0,080	1,02	110,0
883.024	5 A	250 V	50 A	0,077	1,17	175,0
883.025	6,3 A	250 V	63 A	0,073	1,34	281,0

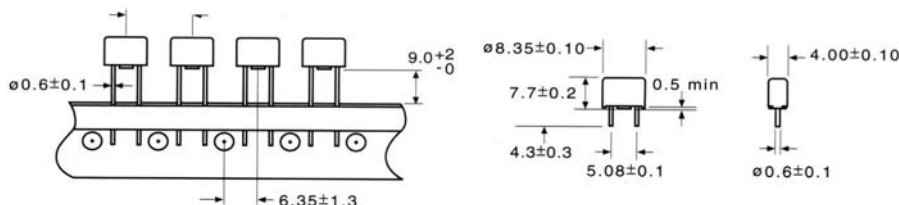

Schmelzzeit-Grenzwert / Pre-arcing time limits

Bemessungsstrom Rated current	1,5 I _{rat} min.	2,1 I _{rat} max.	2,75 I _{rat} min. max.	4 I _{rat} min. max.	10 I _{rat} min. max.
80 mA – 6,3 A	1 h	2 min.	400 ms 10 s	150 ms 3 s	20 ms 150 ms

Bemessungswerte/ Ratings	SMD – Sicherungen / SMD - Fuses			
Produktfoto / product picture				
Typ / type	SMP	SMD 223.000	SMD 224.000	SMD 888.400
Merkmal / characteristic		T	T	F
Strom / current	500 mA – 2 A	1 A – 16 A	1 A – 16 A	500 mA – 12 A
Spannung / voltage	600 V	250 V	250 V	125 V
Ausschaltvermögen / breaking capacity	60 A	400 A	1.500	50 A / 35 A
Prüfzeichen/ approvals				
Norm		IEC 60127-3	IEC 60127-3	UL 248-14
Katalogseite / catalogue page	69	70	71	72

Bemessungswerte/ Ratings	SMD – Sicherungen / SMD - Fuses			
Produktfoto / product picture				
Typ / type	SSQ 220.000	SST 222.000	SSQC	SSTC
Merkmal / characteristic	F	T	F	T
Strom / current	250 mA – 15 A	375 mA – 7 A	250 mA – 8 A	375 mA – 7 A
Spannung / voltage	125 V	125 V	125 V	125 V
Ausschaltvermögen / breaking capacity	50 A	50 A	50 A	50 A
Prüfzeichen/ approvals				
Norm	UL 248-14	UL 248-14		
Katalogseite / catalogue page	73	74	75	76



Material:
Keramikkörper
Verpackungsmöglichkeiten:
2.000 St./ Rolle

Materials:
Ceramic body
Packing opinions:
2.000 pcs. / reel

Technische Spezifikation / Technical Specification:

Schock / Shock Resistance:
MIL-STD-202G, Method 213 B, Test Condition I

Vibration / Vibration Resistance:
MIL – STD-202G, Method 201 A

Salznebel / Salt Spray:
MIL-STD-202G, Method 101 E,
Test condition B (48 hrs)

Isolationswiderstand / Insulation Resistance:
MIL-STD-202G, Method 302
Test Condition A 10.000 ohms min.

Lötbarkeit / Solderability:
MIL-STD-202G, Method 208 H

**Wärmebeständigkeit beim Löten /
Soldering Heat Resistance:**

MIL-STD-202G Method 210 F, Test Condition J

Temperaturtest / Thermal Shock:

MIL-STD-202G, Method 107G, Test Condition B

Temperaturbereich / Operating Temperature:
-55 °C to 125 °C

Bemessungswerte / Ratings

Art.- No.	Strom Current	Spannung Voltage	Ausschaltvermögen Breaking capacity	Spannungsfall Voltage drop (Volt) max.	Max. Verlustleistung Max. power dissipation [W]	Schmelzintegral Melting integral [A ² S]
ES-SMP 500	500 mA	600 V	60 A	0,23	0,20	2,3
ES-SMP 1,25	1,25 A	600 V	60 A	0,18	0,40	17,0
ES-SMP 2	2 A	600 V	60 A	0,16	0,52	37,0

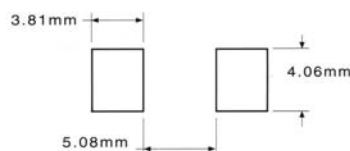
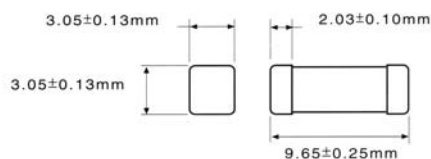

**Material:**

Keramikkörper
Palladium - Messingkappe

Verpackungsmöglichkeiten:

1.000 / 5.000 St. lose oder auf Rolle

Materials:

Ceramic body
Palladium Plated Brass Caps

Packing opinions:

1.000 / 5.000 pcs. in bulk or tape on ree

Bemessungswerte / Ratings

Art.- No.	Strom Current	Spannung Voltage	Ausschaltvermögen Breaking capacity	Spannungsfall Voltage drop (Volt) max.	Max. Verlustleistung Max. power dissipation [W]	Schmelzintegral Melting integral [A ² S]
223.024	1 A	250 V	400 A			
223.027	1,6 A	250 V	400 A			
223.030	2 A	250 V	400 A			
223.031	2,5 A	250 V	400 A			
223.034	3,15 A	250 V	400 A			
223.038	4 A	250 V	400 A	auf Anfrage/ on request	auf Anfrage/ on request	auf Anfrage/ on request
223.039	5 A	250 V	400 A			
223.042	7 A	250 V	400 A			
223.043	10 A	250 V	400 A			
223.044	12 A	250 V	400 A			
223.045	16 A	250 V	400 A			

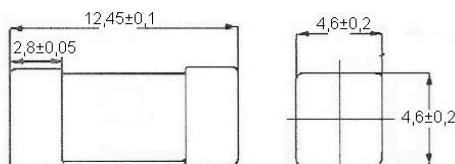



Material:

Keramikkörper
Palladium - Messingkappe

Verpackungsmöglichkeiten:

1.000 / 5.000 St. lose oder auf Rolle

Materials:

Ceramic body
Palladium Plated Brass Caps

Packing opinions:

1.000 / 5.000 pcs. in bulk or tape on reel

Bemessungswerte / Ratings

Art.- No.	Strom Current	Spannung Voltage	Ausschaltvermögen Breaking capacity	Spannungsfall Voltage drop (Volt) max.	Max. Verlustleistung Max. power dissipation [W]	Schmelzintegral Melting integral [A ² S]
224.024	1 A	250 V	1500 A			
224.027	1,6 A	250 V	1500 A			
224.030	2 A	250 V	1500 A			
224.031	2,5 A	250 V	1500 A			
224.034	3,15 A	250 V	1500 A			
224.038	4 A	250 V	1500 A	auf Anfrage/ on request	auf Anfrage/ on request	auf Anfrage/ on request
224.039	5 A	250 V	1500 A			
224.042	7 A	250 V	1500 A			
224.043	10 A	250 V	1500 A			
224.044	12 A	250 V	1500 A			
224.045	16 A	250 V	1500 A			

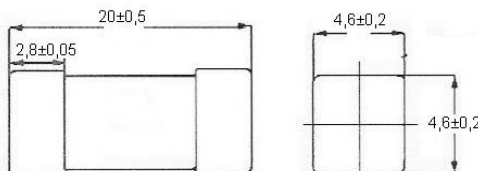



Aufbau:

Keramikrohr

Kontaktkappen:

Messing, versilbert

Verpackungsmöglichkeiten:

100 St. im Polybeutel

1.000 St. per Rolle

Construction:

Ceramik body,

Contact caps:

silver plated brass cap

Packing options:

100 pcs. per plastic bag

1.000 pcs. taped per reel

Bemessungswerte / Ratings

Art.- No.	Strom Current	Spannung Voltage	Ausschaltvermögen Breaking capacity	Spannungsfall Voltage drop max [mV]	Schmelzintegral Melting integral [A ² s]
888.414	500 mA	125 V	50 A	220	0,06
888.416	750 mA	125 V	50 A	170	0,07
888.417	1 A	125 V	50 A	170	0,20
888.419	1,5 A	125 V	50 A	170	0,45
888.420	2 A	125 V	50 A	170	0,64
888.421	2,5 A	125 V	50 A	170	1,25
888.422	3 A	125 V	50 A	150	1,98
888.437	3,5 A	125 V	50 A	150	3,18
888.423	4 A	125 V	50 A	150	3,84
888.424	5 A	125 V	50 A	150	5,60
888.442 ¹⁾	7 A	125 V	35 A	150	10,78
888.427	10 A	125 V	35 A	120	54,00
888.428	12 A	125 V	35 A	103	71,00



Schmelzzeit-Grenzwert / Pre-arcing time limits

Bemessungsstrom Rated current	Ampere rating		Ampere rating 200%
	100%	200%	
500 mA – 10 A 12 A	4 h min.	5 s max.	20 s max.

1) kein UL/ cUL



Material:
Keramikkörper
Palladium - Messingkappe
Verpackungsmöglichkeiten:
5.000 St./ Rolle

Materials:
Ceramic body
Palladium Plated Brass Caps
Packing options:
5.000 pcs. / reel

**Technische Spezifikation /
Technical Specification:**

Schock /Schock Resistance:
MIL-STD-202G, Method 213 B, Test Condition I
Vibration /Vibration Resistance:
MIL - STD-202G, Method 201 A
Salznebel /Salt Spray:
MIL-STD-202G, Method 101 E,
Test condition B (48 hrs)
Isolationswiderstand /Insulation Resistance:
MIL-STD-202G, Method 302
Test Condition A 10.000 ohms min.
Lötbarkeit /Solderability:
MIL-STD-202G, Method 208 H
**Wärmebeständigkeit beim Löten /
Soldering Heat Resistance:**
MIL-STD-202G Method 210 F, Test Condition C
Temperaturtest / Thermal Shock:
MIL-STD-202G, Method 107G, Test Condition B
Temperaturbereich / Operating Temperature:
-55 °C to 125 °C

Bemessungswerte / Ratings

Art.- No.	Strom Current	Spannung Voltage	Ausschaltvermögen Breaking capacity	Spannungsfall Voltage drop (Volt) max.	Schmelzintegral Melting integral [A ² S]	Max. Verlustleistung Max. power dissipation [W]
220.014	250 mA	125 V	50A	0,30	0,01	0,07
220.017	375 mA	125 V	50A	0,25	0,03	0,09
220.019	500 mA	125 V	50A	0,22	0,06	0,11
220.022	750 mA	125 V	50A	0,17	0,07	0,13
220.024	1 A	125 V	50A	0,17	0,14	0,17
220.026	1,25 A	125 V	50A	0,16	0,24	0,20
220.027	1,5 A	125 V	50A	0,15	0,41	0,23
220.030	2 A	125 V	50A	0,15	0,8	0,30
220.032	2,5 A	125 V	50A	0,14	1,4	0,36
220.034	3 A	125 V	50A	0,13	2,4	0,43
220.037	3,5 A	125 V	50A	0,13	3,3	0,47
220.038	4 A	125 V	50A	0,13	4,4	0,51
220.039	5 A	125 V	50A	0,12	7,8	0,62
220.041	6,3 A	125 V	50A	0,12	14,0	0,74
220.042	7 A	125 V	50A	0,114	19,0	0,81
220.015	8 A	125 V	50A	0,112	25,0	0,89
220.043	10 A	125 V	50A	0,107	44,0	1,07
220.044	12 A	125 V	50A	0,103	69,0	1,24
220.045	15 A	125 V	50A	0,098	124,0	1,54

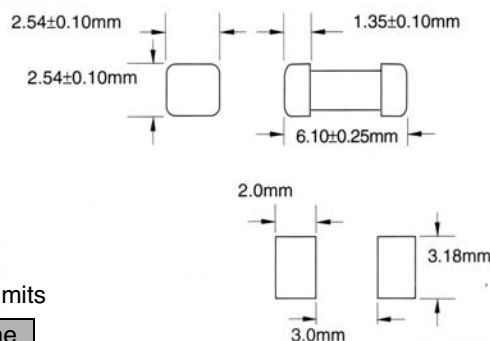

Schmelzeit-Grenzwert / Pre-arcing time limits

Prüfstrom Testing current	Schmelzeit/ Blow Time	
	min	max
100 %	4 h	N / A
200 %	N / A	5 s



Material:
Keramikkörper
Palladium - Messingkappe
Verpackungsmöglichkeiten:
5.000 St./ Rolle

Materials:
Ceramic body
Palladium Plated Brass Caps
Packing opinions:
5.000 pcs. / reel

**Technische Spezifikation /
Technical Specification:**

Schock / Shock Resistance:
MIL-STD-202G, Method 213 B, Test Condition I
Vibration / Vibration Resistance:
MIL - STD-202G, Method 201 A
Salznebel / Salt Spray:
MIL-STD-202G, Method 101 E,
Test condition B (48 hrs)
Isolationswiderstand / Insulation Resistance:
MIL-STD-202G, Method 302
Test Condition A 10.000 ohms min.
Lötbarkeit / Solderability:
MIL-STD-202G, Method 208 H
**Wärmebeständigkeit beim Löten /
Soldering Heat Resistance:**
MIL-STD-202G Method 210 F, Test Condition C
Temperaturtest / Thermal Shock:
MIL-STD-202G, Method 107G, Test Condition B
Temperaturbereich / Operating Temperature:
-55 °C to 125 °C

Bemessungswerte / Ratings

Art.- No.	Strom Current	Spannung Voltage	Ausschaltvermögen Breaking capacity	Spannungsfall Voltage drop (Volt) max.	Schmelzintegral Melting integral [A ² S]	Max. Verlustleistung Max. power dissipation [W]
222.017	375 mA	125 V	50A	0,47	0,15	0,25
222.019	500 mA	125 V	50A	0,43	0,28	0,30
222.020	625 mA	125 V	50A	0,39	0,47	0,35
222.022	750 mA	125 V	50A	0,37	0,69	0,39
222.024	1 A	125 V	50A	0,34	1,3	0,47
222.027	1,5 A	125 V	50A	0,29	3,1	0,62
222.030	2 A	125 V	50A	0,24	5,7	0,68
222.031	2,5 A	125 V	50A	0,21	9,0	0,74
222.034	3 A	125 V	50A	0,18	16,0	0,80
222.037	3,5 A	125 V	50A	0,17	20,0	0,84
222.038	4 A	125 V	50A	0,16	26,0	0,88
222.039	5 A	125 V	50A	0,14	43,0	0,95
222.040	6 A	125 V	50A	0,12	63,0	1,02
222.041	6,3 A	125 V	50A	0,12	70,0	1,03
222.042	7 A	125 V	50A	0,11	90,0	1,08

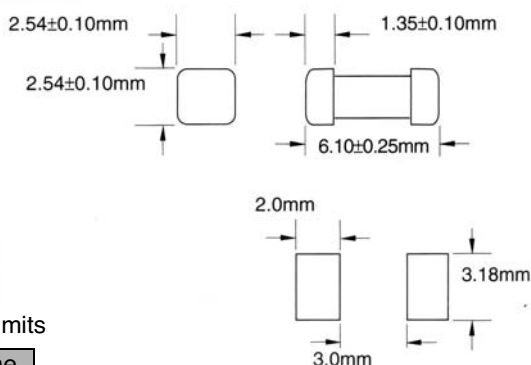

Schmelzzeit-Grenzwert / Pre-arcing time limits

Prüfstrom Testing current	Schmelzzeit/ Blow Time	
	min	max
100 %	4 h	N / A
200 %	1 s	60 s
300 %	0,2 s	3 s
800%	0,02 s	0,1 s

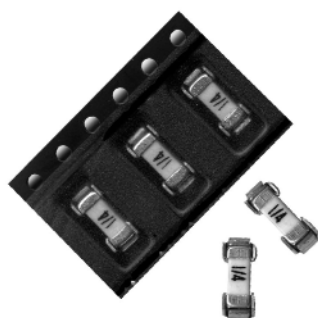
**Material:**

Anschlüsse: Kupferlegierung, verzinkt

Verpackungsmöglichkeiten:

2.000 St./ Rolle

Materials:

Clip Terminals: Tin Plated Inconel Alloy

Packing options:

2.000 pcs. / reel

Technische Spezifikation /**Technical Spezification:****Schock /Schock Resistance:**

MIL-STD-202G, Method 213 B, Test Condition I

Vibration /Vibration Resistance:

MIL – STD-202G, Method 201

Isolationswiderstand /Insulation Resestance:

MIL-STD-202G, Method 302

Test Condition A 10.000 ohms min.

Lötbarkeit /Solderability:

MIL-STD-202G, Method 208

Temperaturtest / Thermal Shock:

MIL-STD-202, Method 107, Test Condition B

Temperaturbereich / Operating Temperature:

-55 °C to 125 °C

Bemessungswerte / Ratings

SSQ Keramikkörper flink SSQ Square Ceramic Surface Mount Quick Action Fuse	
Bestellnummer	Strom / Current
SSQC 250	250 mA
SSQC 375	375 mA
SSQC 500	500 mA
SSQC 750	750 mA
SSQC 1	1 A
SSQC 1,25	1,25 A
SSQC 1,5	1,5 A
SSQC 2	2 A
SSQC 2,5	2,5 A
SSQC 3	3 A
SSQC 3,5	3,5 A
SSQC 4	4 A
SSQC 5	5 A
SSQC 6,3	6,3 A
SSQC 7	7 A
SSQC 8	8 A

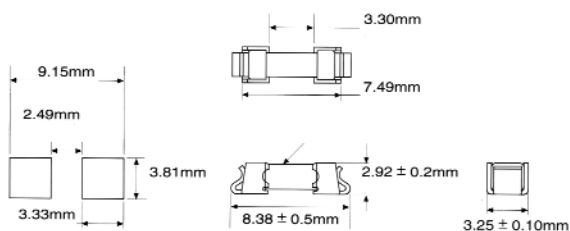

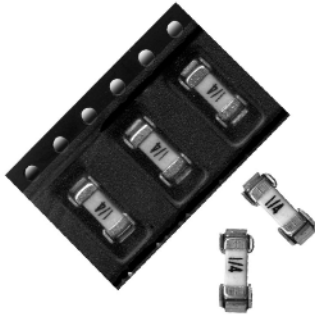
**Material:**

Anschlüsse: Kupferlegierung, verzinkt

Verpackungsmöglichkeiten:

2.000 St./ Rolle

Materials:

Clip Terminals: Tin Plated Inconel Alloy

Packing opinions:

2.000 pcs. / reel

Technische Spezifikation /**Technical Specification:****Schock / Shock Resistance:**

MIL-STD-202G, Method 213 B, Test Condition I

Vibration / Vibration Resistance:

MIL – STD-202G, Method 201

Isolationswiderstand / Insulation Resistance:

MIL-STD-202G, Method 302

Test Condition A 10.000 ohms min.

Lötbarkeit / Solderability:

MIL-STD-202G, Method 208

Temperaturtest / Thermal Shock:

MIL-STD-202, Method 107, Test Condition B

Temperaturbereich / Operating Temperature:

-55 °C to 125 °C

Bemessungswerte / Ratings

SST Keramikkörper träge SST Square Ceramic Surface Mount Slow Blow Fuse	
Bestellnummer	Strom / Current
SSTC 375	375 mA
SSTC 500	500 mA
SSTC 625	625 mA
SSTC 750	750 mA
SSTC 1	1 A
SSTC 1,5	1,5 A
SSTC 2	2 A
SSTC 2,5	2,5 A
SSTC 3	3 A
SSTC 3,5	3,5 A
SSTC 4	4 A
SSTC 5	5 A
SSTC 7	7 A

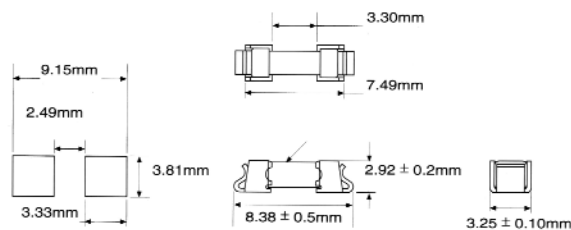

Bemessungswerte/ Ratings	SMD Chip Sicherungen / SMD Chip Fuses			
Produktfoto / product picture				
Typ / type	0402	0603	0805	1206
Merkmal / characteristic	FF	FF	FF	FF
Strom / current	1 A – 2 A	500 mA – 4 A	500 mA – 4 A	500 mA – 5 A
Spannung / voltage	24 V	32 V	32 V	63 V
Ausschaltvermögen / breaking capacity	50 A	50 A	50 A	50 A
Prüfzeichen / approvals				
UL – file-no.	E 163905	E 163905	E 163905	E 163905
Katalogseite / catalogue page	80	81	82	83

Bemessungswerte/ Ratings	SMD Chip Sicherungen / SMD Chip Fuses	
Produktfoto / product picture		
Typ / type	1206 430.000	
Merkmal / characteristic	T	
Strom / current	750 mA – 5 A	
Spannung / voltage	63 V	
Ausschaltvermögen / breaking capacity	50 A	
Prüfzeichen / approvals		
Katalogseite / catalogue page	91	

SMD Dünnschicht Chip Sicherung

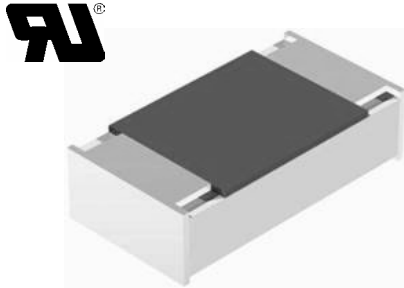

VORTEILE

- Fortschrittliche Dünnschichttechnologie
- Super-Flinke Auslösecharakteristik
- Herausragende Stabilität der Auslösecharakteristik
- Standard metrische SMD Baugrößen
- Umweltfreundliches Produkt, kompatibel zu allen gängigen bleifreien Lötverfahren

ANWENDUNGEN

- Informationstechnologie
- Industrieelektronik
- Automobilelektronik
- Telekommunikation
- Medizingerätetechnik
- Audio- und Videoelektronik

Die SMD Dünnschicht Chip Sicherung ist die optimale Wahl für eine Vielzahl modernster elektronischer Baugruppen. Das hochautomatisierte Herstellungsverfahren garantiert eine herausragende Stabilität der Auslösecharakteristik. Typische Anwendungsbereiche befinden sich in Applikationen aus der Informationstechnologie, Telekommunikation, Medizingerätetechnik, Industrieelektronik, Audio- und Videoelektronik, sowie Anwendungen aus der Automobilelektronik.

METRISCHE BAUGRÖSSEN				
ZÖLLISCH:	0402	0603	0805	1206
METRISCH:	RR 1005M	RR 1608M	RR 2012M	RR 3216M

TECHNISCHE SPEZIFIKATION				
BESCHREIBUNG	FUSE 0402 ⁽¹⁾	FUSE 0603	FUSE 0805	FUSE 1206
Metrische Baugröße	RR 1005M	RR 1608M	RR 2012M	RR 3216M
Bemessungsstrom I_R	1.0 A to 2.0 A	0,5 A to 4,0 A	0,5 A to 4,0 A	0,5 A to 5,0 A
Bemessungsspannung, U_{max} AC/DC	24V	32 V	32 V	63 V
Bemessungsausschaltvermögen, $I_{max}@U_{max}$ DC	50 A @ 24 V	50 A @ 32 V	50 A @ 32 V	50 A @ 63 V
Spannungsfall @ $1 \times I_R$	170 mV to 220 mV	140 mV to 415 mV	145 mV to 430 mV	150 mV to 460 mV
Kalt-Widerstand @ $0.1 \times I_R$	65 m Ω to 170 m Ω	23 m Ω to 640 m Ω	24 m Ω to 660 m Ω	24 m Ω to 670 m Ω
Klima Kategorie (LCT/UCT/Tage)	55/125/56	55/125/56	55/125/56	55/125/56
Zulässiger kontinuierlicher Dauerstrom @ $\vartheta_{amb.} = 23 \text{ }^\circ\text{C}$	$0.7 \times I_R$	$0,7 \times I_R$	$0,7 \times I_R$	$0,7 \times I_R$
Freigabe	UL -file-no. E163905	E163905	E163905	E163905

Hinweis:

1. FUSE 0402 nur auf Anfrage verfügbar.

BESTELLHINWEISE – Typenbeschreibung und Bestellnummern⁽¹⁾

FUSE	0603	-FF	PW	1A0
TYP	BAUGRÖSSE	AUSLÖSE-CHARAKTERISTIK	VERPACKUNGEN	BEMESSUNGSSTROM ⁽²⁾
FUSE = SMD Chip Sicherung	0402 0603 0805 1206	FF = Super Flink	Papierband 2 mm Lochabstand 0402 E0 = 20 000 Stück E5 = 5 000 Stück E1 = 1000 Stück Papierband 4 mm Lochabstand 0603 PW = 20 000 Stück 0805 P5 = 5 000 Stück 1206 P1 = 1 000 Stück	Siehe Nennwerttabellen

Hinweis:

- Um mögliche Fehler bei der Bestellung zu vermeiden, empfehlen wir die Klartextbestellbezeichnung zu verwenden.
- Bemessungsstrom in A.
Beispiele:
500 mA = 0A5
6,3 A = 6A3

ABMESSUNGEN

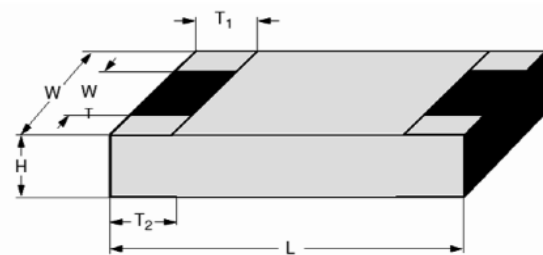

ABMESSUNGEN – SMD Chip Sicherungen, Abmessungen und relevante physikalische Maße

TYPE	H (mm)	L (mm)	W (mm)	W _T (mm)	T ₁ (mm)	T ₂ (mm)	MASSE (mg)
FUSE 0402	0.32 ±0.05	1.0 ±0.05	0.5 ±0.05	> 75 % of W	0.2 +0.1/-0.15	0.2 ±0.1	0.65
FUSE 0603	0.45 +0.1/-0.05	1.55 ±0.05	0.85 ±0.1	> 75 % of W	0.3 + 0.15/-0.2	0.3 + 0.15/-0.2	1.9
FUSE 0805	0.45 +0.1/-0.05	2.0 ±0.1	1.25 ±0.15	> 75 % of W	0.4 +0.1/-0.2	0.4 + 0.1/-0.2	4.7
FUSE 1206	0.55 ±0.1	3.2 +0.1/-0.2	1.6 ±0.15	> 75 % of W	0.5 ±0.25	0.5 ±0.25	9.5

**Metrische Baugröße:**

RR 1005M

Metric Size:

RR 1005M

Bemessungswerte / Ratings

Art.- No. ¹	Bauform Size	Strom Current ²	Spannung Voltage	Ausschaltvermögen Breaking capacity	Spannungsfall Voltage drop ³ [mV] max.	Schmelzintegral Melting integral ² [A ² S]
Fuse 0402-FF E0 1A0	0402	1 A	24 V	50 A	220	0,0028
Fuse 0402 FF E0 1A25	0402	1,25 A	24 V	50 A	182	0,0039
Fuse 0402 FF E0 1A5	0402	1,5 A	24 V	50 A	169	0,0059
Fuse 0402 FF E0 1A75	0402	1,75 A	24 V	50 A	160	0,0065
Fuse 0402 FF E0 2A0	0402	2 A	24 V	50 A	167	0,0077

Hinweis / Note:

1. Fuse 0402 nur auf Anfrage verfügbar / only on request
2. Weitere Bemessungsstromwerte sind auf Anfrage verfügbar / Other values of rated current are available on request
3. Typische Werte / Typical values
4. Für Verpackungseinheiten von 1.000 Stück E1 anstelle von E0 verwenden /
For packages with 1.000 pieces, please use for packaging E1 instead of E0
5. Für Verpackungseinheiten von 5.000 Stück E5 anstelle von E0 verwenden /
For packages with 5.000 pieces, please use for packaging E5 instead of E0

Metrische Baugröße:
RR 1608M

Metric Size:
RR 1608M

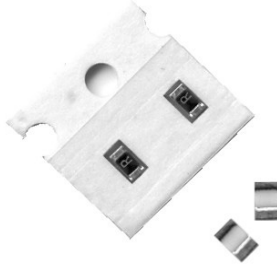

Bemessungswerte / Ratings

Art.- No. ^{3,4}	Bauform Size	Strom Current ¹	Spannung Voltage	Ausschaltvermögen Breaking capacity	Spannungsfall Voltage drop ² [mV] max.	Schmelzintegral Melting integral ² [A ² S]
Fuse 0603-FF PW 0A5	0603	500 mA	32 V	50 A	415	0,0009
Fuse 0603-FF PW0A63	0603	630 mA	32 V	50 A	334	0,0014
Fuse 0603-FF PW0A75	0603	750 mA	32 V	50 A	278	0,0020
Fuse 0603-FF PW 0A8	0603	800 mA	32 V	50 A	243	0,0023
Fuse 0603-FF PW 1A0	0603	1 A	32 V	50 A	220	0,0028
Fuse 0603-FF PW1A25	0603	1,25 A	32 V	50 A	182	0,0039
Fuse 0603-FF PW 1A5	0603	1,5 A	32 V	50 A	169	0,0059
Fuse 0603-FF PW 1A6	0603	1,6 A	32 V	50 A	160	0,0065
Fuse 0603-FF PW1A75	0603	1,75 A	32 V	50 A	167	0,0077
Fuse 0603-FF PW 2A0	0603	2 A	32 V	50 A	170	0,0101
Fuse 0603-FF PW 2A5	0603	2,5 A	32 V	50 A	150	0,0157
Fuse 0603-FF PW 3A0	0603	3 A	32 V	50 A	140	0,0227
Fuse 0603-FF PW3A15	0603	3,15 A	32 V	50 A	135	0,0250
Fuse 0603-FF PW 3A5	0603	3,5A	32 V	50 A	135	0,0308
Fuse 0603-FF PW 4A0	0603	4 A	32 V	50 A	142	0,0403

Hinweis / Note:

1. Weitere Bemessung sind auf Anfrage verfügbar / Other values of rated current are available on request
2. Typische Werte / Typical values
3. Für Verpackungseinheiten von 1.000 Stück P1 anstelle von PW verwenden /
For packages with 1.000 pieces, please use for packaging P1 instead of PW
4. Für Verpackungseinheiten von 5.000 Stück P5 anstelle von PW verwenden /
For packages with 5.000 pieces, please use for packaging P5 instead of PW



Metrische Baugröße:
RR 2012M

Metric Size:
RR 2012M

Bemessungswerte / Ratings

Art.- No. ³⁾⁴⁾	Bauform Size	Strom Current ¹⁾	Spannung Voltage	Ausschaltvermögen Breaking capacity	Spannungsfall Voltage drop ²⁾ @ 100 % /n (mV) max.	Schmelzintegral Melting integral ²⁾ I ² T@ 10 / _R [A ² Sec]
Fuse 0805-FF PW 0A5	0805	500 mA	32 V	50 A	430	0,0009
Fuse 0805-FF PW0A63	0805	630 mA	32 V	50 A	350	0,0014
Fuse 0805-FF PW0A75	0805	750 mA	32 V	50 A	297	0,0021
Fuse 0805-FF PW 0A8	0805	800 mA	32 V	50 A	259	0,0023
Fuse 0805-FF PW 1A0	0805	1 A	32 V	50 A	240	0,0028
Fuse 0805-FF PW1A25	0805	1,25 A	32 V	50 A	210	0,0040
Fuse 0805-FF PW 1A5	0805	1,5 A	32 V	50 A	180	0,0059
Fuse 0805-FF PW 1A6	0805	1,6 A	32 V	50 A	175	0,0065
Fuse 0805-FF PW1A75	0805	1,75 A	32 V	50 A	174	0,0077
Fuse 0805-FF PW 2A0	0805	2 A	32 V	50 A	173	0,0101
Fuse 0805-FF PW 2A5	0805	2,5 A	32 V	50 A	159	0,0157
Fuse 0805-FF PW 3A0	0805	3 A	32 V	50 A	149	0,0227
Fuse 0805-FF PW3A15	0805	3,15 A	32 V	50 A	145	0,0250
Fuse 0805-FF PW 3A5	0805	3,5 A	32 V	50 A	144	0,0308
Fuse 0805-FF PW 4A0	0805	4 A	32 V	50 A	145	0,0403

Hinweis / Note:

- Weitere Bemessung sind auf Anfrage verfügbar / Other values of rated current are available on request
- Typische Werte / Typical values
- Für Verpackungseinheiten von 1.000 Stück P1 anstelle von PW verwenden /
For packages with 1.000 pieces, please use for packaging P1 instead of PW
- Für Verpackungseinheiten von 5.000 Stück P5 anstelle von PW verwenden /
For packages with 5.000 pieces, please use for packaging P5 instead of PW

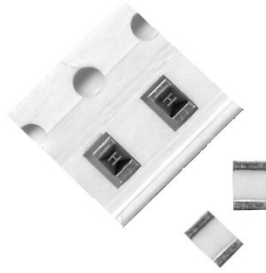

Metrische Baugröße:
RR 3216M

Metric Size:
RR 3216M

Bemessungswerte / Ratings

Art.- No. ^{3,4}	Bauform Size	Strom Current ¹	Spannung Voltage	Ausschaltvermögen Breaking capacity	Spannungsfall Voltage drop ² [mV] max.	Schmelzintegral Melting integral ² [A ² S]
Fuse 1206-FF PW 0A5	1206	500 mA	63 V	50 A	440	0,0009
Fuse 1206-FF PW0A63	1206	630 mA	63 V	50 A	366	0,0014
Fuse 1206-FF PW0A75	1206	750 mA	63 V	50 A	327	0,0022
Fuse 1206-FF PW 0A8	1206	800 mA	63 V	50 A	290	0,0023
Fuse 1206-FF PW 1A0	1206	1 A	63 V	50 A	264	0,0028
Fuse 1206-FF PW1A25	1206	1,25 A	63 V	50 A	231	0,0041
Fuse 1206-FF PW 1A5	1206	1,5 A	63 V	50 A	208	0,0059
Fuse 1206-FF PW 1A6	1206	1,6 A	63 V	50 A	180	0,0066
Fuse 1206-FF PW1A75	1206	1,75 A	63 V	50 A	176	0,0077
Fuse 1206-FF PW 2A0	1206	2 A	63 V	50 A	182	0,0102
Fuse 1206-FF PW 2A5	1206	2,5 A	63 V	50 A	162	0,0159
Fuse 1206-FF PW 3A0	1206	3 A	63 V	50 A	143	0,0229
Fuse 1206-FF PW3A15	1206	3,15 A	63 V	50 A	137	0,0251
Fuse 1206-FF PW 3A5	1206	3,5A	63 V	50 A	129	0,0310
Fuse 1206-FF PW 4A0	1206	4 A	63 V	50 A	132	0,0404
Fuse 1206-FF PW 5 A0	1206	5 A	63 V	50 A	180	0,0631

Hinweis / Note:

- Weitere Bemessung sind auf Anfrage verfügbar / Other values of rated current are available on request
- Typische Werte / Typical values
- Für Verpackungseinheiten von 1.000 Stück P1 anstelle von PW verwenden /
For packages with 1.000 pieces, please use for packaging P1 instead of PW
- Für Verpackungseinheiten von 5.000 Stück P5 anstelle von PW verwenden /
For packages with 5.000 pieces, please use for packaging P5 instead of PW

BESCHREIBUNG

Um die Reproduzierbarkeit sicherzustellen, folgt die Produktion einem umfassenden Satz an Verfahrens-Anweisungen und wird strengstens kontrolliert. Eine gleichmäßige und homogene Metallschicht wird auf einen hochwertigen keramischen Grundkörper (96 % Al₂O₃) aufgetragen. Das Sicherungselement wird durch eine Schutzabdeckung vor elektrischen, mechanischen und klimatischen Einflüssen geschützt. Die Kontakte erhalten auf der Nickel-Sperrschicht eine Reinzinn-Oberfläche.

Jedes einzelne Produkt wird zielgerichtet gefertigt und durch einen umfassenden Prüfablauf getestet. Lediglich Produkte die unserem hohen Qualitätsniveau genügen werden direkt in einen Papiergurt gemäß **IEC 60286-3** verpackt.

VERARBEITUNG

Die Sicherungen können durch vollautomatische SMD-Bestückungsautomaten und durch automatische Lötanlagen, wie Wellen-, Reflow-, und Dampfphasenanlagen, verarbeitet werden. Die Schutzabdeckung ist gegen übliche Reinigungslösungen der Elektronikindustrie, wie Alkohole, Ester und wässrige Lösungen, beständig. Die Sicherungen sind bleifrei (Kategorie **e3**), die Reinzinn-Oberfläche ist kompatibel zu bleifreien als auch zu bleihaltigen Lötverfahren. Die Immunität gegenüber dem Wachstum von Zinn-Whisker wurde durch umfassende Prüfungen bestätigt. Alle Produkte erfüllen die gesetzlichen vorgeschriebenen CEFIC-EECA-EICTA Verbotsrichtlinien der Verwendung gefährliche Substanzen.

Dies schließt die vollständige Einhaltung der folgenden Richtlinien mit ein:

- 2000/53/EC End of Vehicle life Directive (ELV)
- 2000/53/EC Annex II to End of Vehicle Life Directive (ELV II)
- 2002/95/EC Restriction of the use of Hazardous Substances Directive (RoHS)
- 2002/96/EC Waste Electrical and Electronic Equipment Directive (WEEE)

Die Lötbarkeit ist mit 2 Jahren nach Herstellung oder nach einer entsprechenden Re-Qualifizierung spezifiziert. Die zulässige Lagerzeit beträgt 20 Jahre.

ANERKENNUNGEN

Die Sicherungen sind im Einklang mit den Normen **UL 248-14** und **IEC 60127-4**, welche auf die Normen **UL 248-1**, **IEC 60127-1** und der **IEC 60068** Serie verweisen, getestet.

Die Anerkennung der Sicherung gemäß der Norm **UL 248-14** wird durch das entsprechende **UL** Zeichen auf dem Etikett gekennzeichnet.



**Bleifrei-Kennzeichnung
auf dem Etikett**

CHARAKTERISTISCHE EIGENSCHAFTEN

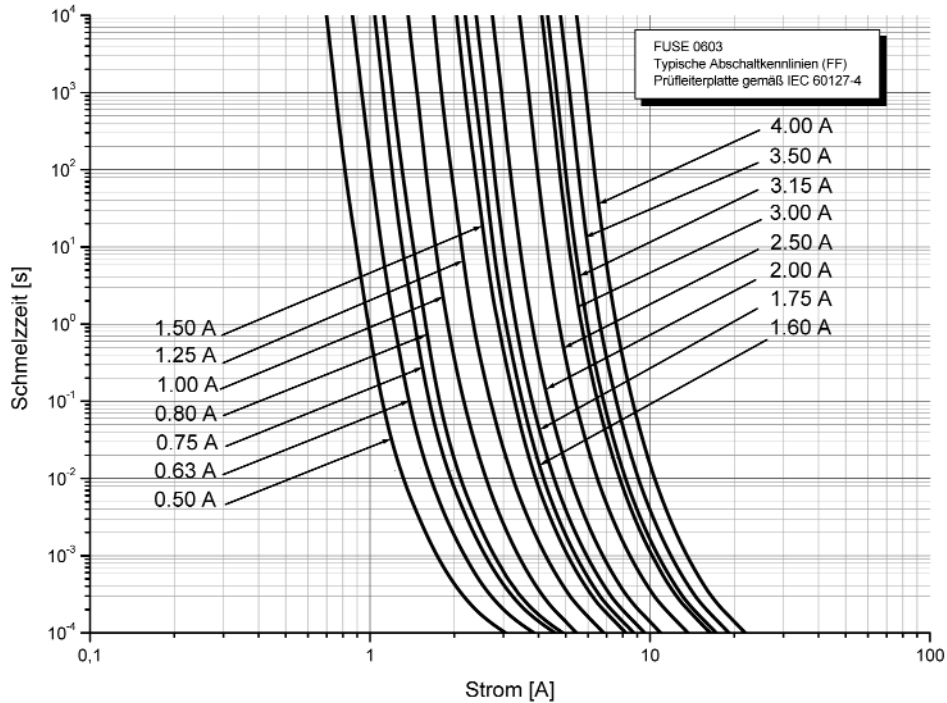

Typische I-t-Abschaltkurven der FUSE 0603

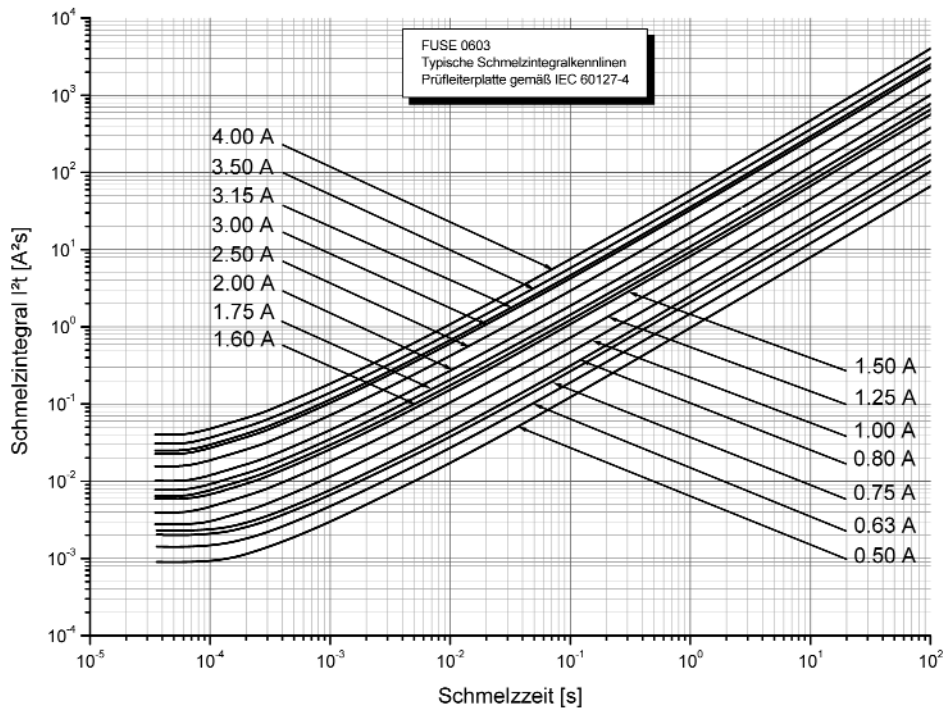

Typische I²t - t Kurven der FUSE 0603

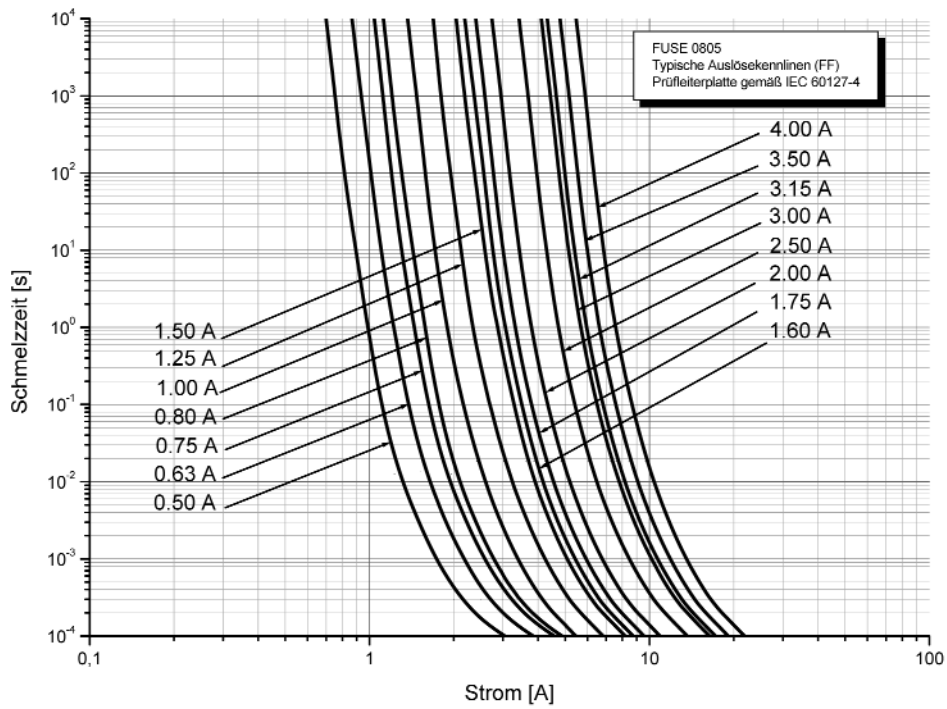

Typische I-t-Abschaltkurven der FUSE 0805

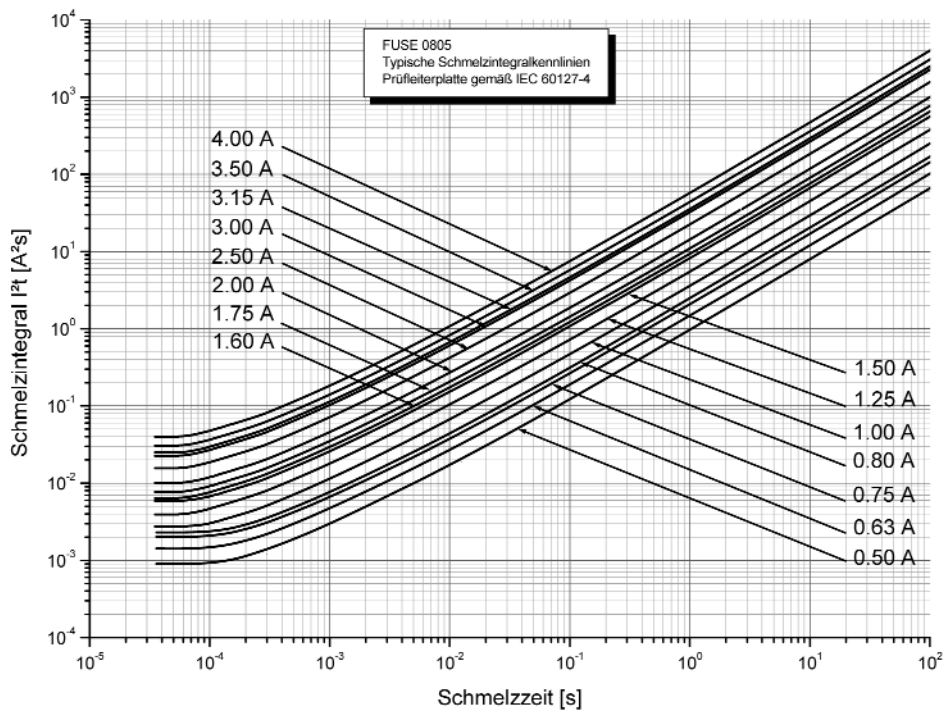

Typische I^2t - t Kurven der FUSE 0805

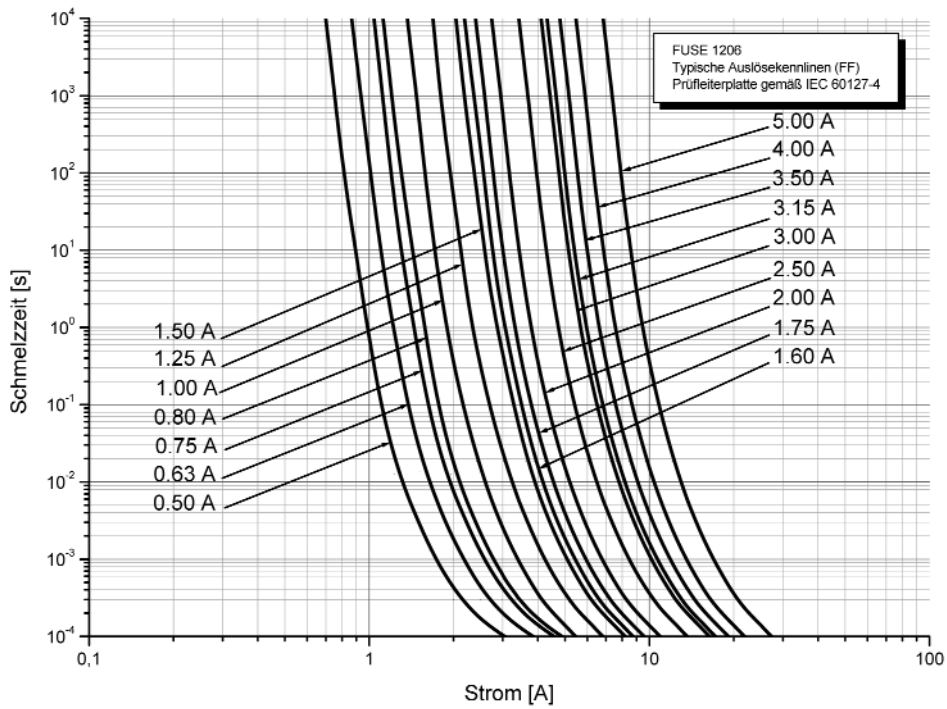

Typische I-t-Abschaltkurven der FUSE 1206

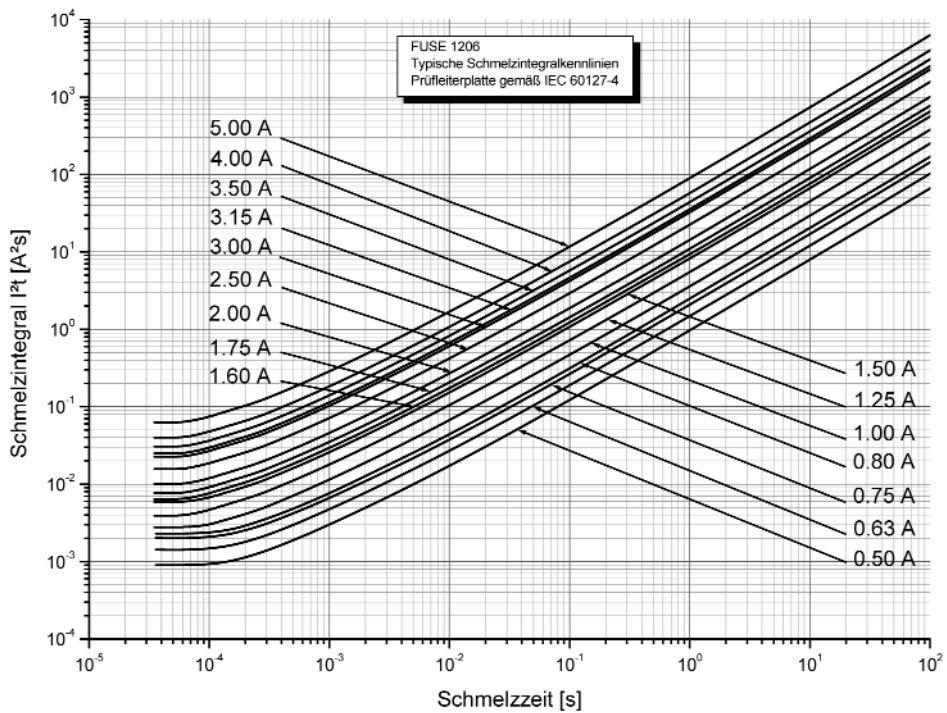

Typische I^2t - t Kurven der FUSE 1206

PRÜFUNGEN UND ANFORDERUNGEN

Alle Prüfungen werden in Einklang mit den folgenden Normen durchgeführt:

IEC 60127-1, Miniature fuse – Part 1: Definitions for miniature fuses and general requirements for miniature fuse-links

IEC 60127-4, Universal Modular Fuse Links (UMF)

UL 248-1, Low voltage fuses – Part1: General Requirements

UL 248-14, Low voltage fuses – Part14: Supplemental Fuses

Der vollständige Prüfplan kann den obigen Dokumenten entnommen werden. Durch diese Prüfungen werden die meisten Anforderungen seitens METI und CCC erfüllt.

Die Prüfungen werden gemäß IEC 60068 und unter normalen atmosphärischen Bedingungen gemäß IEC 60068-1 durchgeführt, 5.3 Klimakategorie LCT/UCT/56 (Nenntemperaturbereich: Untere Kategorietemperatur, Obere Kategorietemperatur, Feuchte-Wärme, Langzeit, 56 Tage) sind zulässig.

Solange keine anderen Werte festgelegt werden, kommen folgende Werte zur Anwendung:

Temperatur: 15 °C bis 35 °C

Relative Feuchtigkeit: 45 % bis 75 %

Luftdruck: 86 kPa bis 106 kPa (860 mbar bis 1 060 mbar).

Solange nicht anders festgelegt wurde, werden die Prüflinge auf eine Prüfleiterplatte gemäß IEC 60127-4 befestigt.

Die Anforderungen, wie in der Tabelle: Prüfverfahren und Anforderungen festgelegt sind entsprechen den Prüfbedingungen und zulässigen Grenzwerten der IEC 60127-1 bzw. IEC 60127-4. Jedoch sind einige zusätzliche Prüfungen und Verbesserungen diesen geringsten Anforderungen hinzugefügt worden.

PRÜFVERFAHREN UND ANFORDERUNGEN				
				W (ΔR/R)
8.3.2	21 (Ue ₁)	Trägerbiegeprüfung	Tiefe 1mm; Geschwindigkeit 1 mm/s Widerholungen: 1	kein sichtbarer Schaden ΔR/R ≤ ± 10 %
8.6.2	58 (Td)	Lötbarkeit	Lötbadmethode; SnPb40; kein aktiviertes Flussmittel; (215 ± 3) °C; (3 ± 0,3) s	gute Benetzbarkeit (95 % bedeckt); kein sichtbarer Schaden
			Lötbadmethode; SnAg3Cu0,5 oder SnAg3,5; kein aktiviertes Flussmittel; (235 ± 3) °C; (2 ± 0,2) s	gute Benetzbarkeit (95 % bedeckt); kein sichtbarer Schaden
8.7.2	58 (Td)	Lötwärmebeständigkeit	Lötbadmethode; (260 ± 5) °C; (10 ± 1) s	kein sichtbarer Schaden ΔR/R ≤ ± 10 %
			Reflow-Lötverfahren 2 (IR/erzwungene Gaskonvektion); (260 ± 5) °C; (10 ± 1) s	kein sichtbarer Schaden ΔR/R ≤ ± 10 %
9.2.1	—	Auslösecharakteristik bei Raumtemperatur	Kaltwiderstand bei 0.1 x I _R ; zerstörende Prüfung durch Überlastbedingungen (Gleichstrom)	bei 1.25 x I _R , t _{pre-arc} > 1 h bei 2.0 x I _R , t _{pre-arc} < 5 s bei 10 x I _R , t _{pre-arc} < 0.001 s (FF)
9.3.2	—	Bemessungsabschaltvermögen	50 A bei Nennspannung gemäß UL 248-14	Sichtprüfung kein sichtbarer Schaden

PRÜFVERFAHREN UND ANFORDERUNGEN						
9.3.3	—	Restwiderstand	50 A bei Nennspannung gemäß UL 248-14	Isolationswiderstandwert bei $2.0 \times U_R$ (DC) größer $0,1 \text{ M}\Omega$		
				W ($\Delta R/R$)		
9.4	—	Dauerprüfung gemäß IEC 60127-1	a) $I = 1.0 \times I_R$ (DC) 1.0 h Ein; 0,25 h Aus; 23 °C; 100 Zyklen b) $I = 1.25 \times I_R$ (DC) 1.0 h Ein 23 °C; 1 Zyklus	FUSE 0603	$\leq 3.15 \text{ A}$	kein sichtbarer Schaden $\Delta R/R \leq \pm 10 \%$
				FUSE 0805	$\leq 3.15 \text{ A}$	
				FUSE 1206	$\leq 3.15 \text{ A}$	
—	—	Überprüfung des Temperaturanstieges und der Strombelastbarkeit gemäß UL 248-14 Abschnitt 8.2.3	$I = 1.0 \times I_R$ (DC)	FUSE 0603	$\leq 4.0 \text{ A}$	Temperaturanstieg der wärmsten Stelle $\leq 75 \text{ K}$ gemäß UL 248-14 Abschnitt 8.2.4
				FUSE 0805	$\leq 4.0 \text{ A}$	
				FUSE 1206	$\leq 4.0 \text{ A}$	
9.5	—	Maximale zulässige Dauerverlustleistung gemäß IEC 60127-1	Berechnung der Werte aus den Ergebnissen der Prüfung Abschnitt 9.4 b)	Dauerverlustleistung \leq gemäß IEC 60127-4 Tabelle 2		
9.7	—	Anschlusstemperatur	Prüfung ist während er letzten 5 Minuten von Abschnitt 9.4 b) durchzuführen	FUSE 0603	$\leq 3.15 \text{ A}$	Temperaturanstieg der Anschlüsse $\leq 85 \text{ K}$
				FUSE 0805	$\leq 3.15 \text{ A}$	
				FUSE 1206	$\leq 3.15 \text{ A}$	
—	78 (Cab)	Feuchte-Wärme-Konstant	$(40 \pm 2) \text{ °C}$; 56 Tage; $(93 \pm 3) \%$ RF	$\Delta R/R \leq \pm 10\%$ Auslösekennlinien		
—	14 (Na)	Temperaturwechsel	30 min. bei LCT; 30 min. bei UCT LCT = -55 °C UCT = 125 °C 5 Zyklen	$\Delta R/R \leq \pm 10\%$		
—	6 (Fc)	Vibrationen	Frequenzbereich bei 10 bis 2 000 Hz; keine Resonanz; Amplitude 1,5 mm oder 200 m/s^2 ; 6 h	$\Delta R/R \leq \pm 10\%$		
—	45 (XA)	Lösemittelbeständigkeit	Isopropylalkohol; 50 °C; Methode 2	kein sichtbarer Schaden		
—	45 (XA)	Lösemittelbeständigkeit der Kennzeichnung	Isopropylalkohol; 50 °C; Methode 1,	Kennzeichnung lesbar, kein sichtbarer Schaden		
—	21 (Ue ₃)	Abscherfestigkeit	RR 1608M; 9 N	kein sichtbarer Schaden		
			RR 2012M; 45 N			
—	—	Entflammbarkeit	IEC 60695-2-2, Nadelflammentest; 10 s	keine Flammen nach 30 s		

MATERIAL REFERENZNUMMER

Bauelemente können durch die Verwendung einer einfachen Klartext-Bestellbezeichnung bestellt werden, siehe Tabelle "BESTELLHINWEISE – Typenbeschreibung und Bestellnummern".

Zusätzlich können die Bauelemente über eine 18-stellige alphanumerische Material Referenznummer identifiziert werden.

MATERIAL REFERENZNUMMER KODIERUNG – FUSE Serie

TYP	BAU-GRÖSSE	AUSLÖSE-KENNLINIE	BEMESSUNGS-STROM	VERPACKUNG	SONDER-KENNZEICHNUNG
FUSE	0603	FF	01000	PW	0
4 Stellen	4 Stellen	2 Stellen	5 Stellen	2 Stellen	1 Stelle
FUSE =SMD Sicherung	0603 0805 1206	FF = Super Flick	Bemessungs- strom in mA. Beispiele: 0,5 A = 00500 6,3 A = 06300	Papierband 4 mm Abstand PW = 20 000 Stück P5 = 5 000 Stück P1 = 1 000 Stück	0 = Standard Produkt

**Aufbau:**

Keramikkörper

Verpackungsmöglichkeiten:

5.000 St. / Rolle

Construction:

Ceramic tube

Packing opinions:





5.000 pcs. / reel



Bemessungswerte / Ratings



Art.- No.	Strom Current	Spannung Voltage	Ausschaltvermögen Breaking capacity	Spannungsfall Voltage drop max [mV]	Verlustleistung power dissip. Max [W]	Schmelzintegral Melting integral [A ² s]
430.022	750 mA	63 V	50 A	0,442	0,40	0,037
430.017	1 A	63 V	50 A	0,325	0,39	0,068
430.018	1,25 A	63 V	50 A	0,363	0,54	0,11
430.019	1,5 A	63 V	50 A	0,313	0,56	0,24
430.020	2 A	63 V	50 A	0,250	0,60	0,44
430.021	2,5 A	63 V	50 A	0,212	0,64	0,74
430.016	3 A	63 V	50 A	0,189	0,68	1,11
430.037	3,5 A	63 V	50 A	0,173	0,74	1,58
430.023	4 A	63 V	50 A	0,165	0,79	2,00

Schmelzzeit-Grenzwert / Pre- arcing time limits

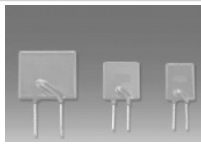
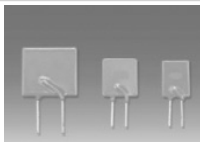
Prüfstrom Testing current	Schmelzzeit / Blow Time	
	Minimum	Maximum
100 %	4 hrs	N / A
200 %	1 sec	120 sec
300 %	0,1 sec	3 sec
800 %	0,002 sec	0,05 sec



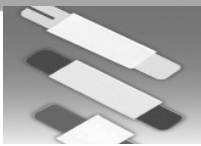

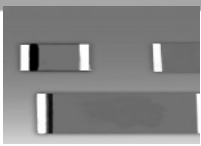
Bemessungswerte/ Ratings	PTC – Sicherungen / PTC -Fuses			
Produktfoto / product picture				
Typ / type	LB	LBV	LP 60	LBR
Abmessungen / dimensions	4,8-13,5 x 9,3-14,6 mm	13,5 x 14,5 mm	5,7-28,5 x 10,5-32,5 mm	5,5-13,0x7,6 mm
V max.	250 V	600 V	60 V	90 V
I max.	3 A - 10 A	3 A	40 A	20 A
I H	0,080 A - 0,180 A	0,150 A - 0,160 A	0,05 A - 3,75 A	0,20 A - 0,90 A
I T	0,160 A - 0,360 A	0,300 A - 0,320 A	0,10 A - 7,50 A	0,40 A - 1,80 A
Besonderheiten / features	runder Körper; ab IH 0,120 A rechteckiger Körper / round corpus; ex IH 0,120 A square corpus	rechteckiger Körper / square corpus	gesickte Drähte; ab IH 1,10 A gerade Drähte / kinked lead options; ex IH 1,10 A straight wires	runder Körper / round corpus





Bemessungswerte/ Ratings	PTC – Sicherungen / PTC -Fuses			
Produktfoto / product picture				
Typ / type	LP 30	LP 16	LP 06	LP
Abmessungen / dimensions	6,0-24,5 x 13,8-36,4 mm	7,8-28,6 x 11,7-28,7 mm	6,4-11,5 x 11,4-20,4 mm	20,0-31,0 x 5,2-13,3 mm
V max.	30 V	16 V	6 V	15 - 30 V
I max.	40 A	100 A	40 A	100 A
I H	0,90 A - 9,00 A	3,0 A - 14,0 A	0,75 A - 2,50 A	0,70 A - 4,20 A
I T	1,80 A - 18,00 A	5,1 A - 23,8 A	1,30 A - 5,00 A	1,45 A - 7,60 A
Besonderheiten / features	rechteckiger Körper / square corpus	rechteckiger Körper / square corpus	rechteckiger Körper; IH 0,75 A und 1,20 A runder Körper /square corpus; IH 0,75 A and 1,20 A round corpus	Streifen-Sicherung / Strip-Fuse

Bemessungswerte/ Ratings	PTC – Sicherungen / PTC -Fuses		
Produktfoto / product picture			
Typ / type	LP-CW	LP-SM	LP-MSM
Abmessungen / dimensions	17,5-43,0 x 3,8-17,3 mm	7,98-9,50 x 3,00-3,18 mm	4,73-11,51 x 3,41-5,33 mm
V max.	16 V	6 V - 60 V	6 V - 60 V
I max.	100 A	10 A - 40 A	10 A - 100 A
I H	1,70 A - 2,50 A	0,30 A - 3,00 A	0,10 A - 2,60 A
I T	3,40 A - 5,40 A	0,60 A - 6,00 A	0,20 A - 5,20 A
Besonderheiten / features	Streifen-Sicherung / Strip-fuse	Oberflächenmontage / Surface mount	Oberflächenmontage / Surface mount

Bemessungswerte/ Ratings	CPTC – Sicherungen / CPTC -Fuses			
Produktfoto / product picture				
Typ / type	SCA	SCB	SCC	SCD
Abmessungen / dimensions	9,0-14,0 x 11,0-16,5 mm	6,5-22,0 x 9,0-25,5 mm	10-14 x 10-20 mm	6,5-9,5 x 11-13 mm
V max.	220 - 650 V	140 - 600 V	16 - 48 V	500 - 1000 V
I max.	siehe Katalog	0,2 A - 8 A	3 A - 8 A	0,25 A - 0,5 A
I H	0,060 A - 0,220 A	0,015 A - 0,600 A	0,200 A - 1,600 A	0,004 A - 0,025 A
I T	0,120 A - 0,440 A	0,040 A - 1,200 A	0,500 A - 3,200 A	0,0065 A-0,055 A
Besonderheiten / features	runder Körper / round corpus	runder Körper / round corpus	runder Körper / round corpus	runder Körper / round corpus

Bemessungswerte/ Ratings	CPTC – Sicherungen / CPTC -Fuses			
Produktfoto / product picture				
Typ / type	SCE	SCF	SCG	SCP
Abmessungen / dimensions	20 x 20 mm	13,2 x 13,2 mm	30 x 30 mm	11,5 x 8,1 mm
V max.	380 - 600 V	140 - 270 V	48 - 500 V	220 - 380 V
I max.	7 A - 13 A	siehe Katalog	6 A - 20 A	siehe Katalog
I H	siehe Katalog	siehe Katalog	0,65 A - 4 A	0,060 A - 0,140 A
I T	siehe Katalog	siehe Katalog	1,30 A - 8,00 A	0,140 A - 0,280 A
Besonderheiten / features	runder Körper ohne Drahtanschlüsse / round corpus without pins	runder Körper ohne Drahtanschlüsse / round corpus without pins	rechteckiger Körper ohne Draht- anschlüsse / square corpus without pins	runder Körper ohne Drahtanschlüsse / round corpus without pins

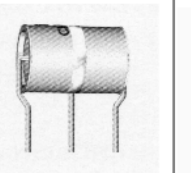
Bemessungswerte/ Ratings	Gasentladungsableiter / Gas Discharge Tube				
Produktfoto / product picture					
Bauform / construction	2 polig 2 electrode	2 polig 2 electrode	2 polig 2 electrode	2 polig 2 electrode	Glas / Metall glass / metal
Typ / type	BA 600.000	BB 610.000	BH 620.000	CA8BC 630.000	P 100 640.000
Ansprechspannung / breakdown voltage (V)	90 - 550	75 - 550	90 - 3.500	230 - 540	150 - 750
Dynamik (1kV/μs)	<700 - <1.200	<700 - <1.200	<700 - <4.600	<700 - <1.200	< 700 - <1.600
Löschspannung / holdover voltage (V)	>60 / >80	>60 / >80	>80 / >120	> 80	>80
Stoßstrom/ discharge current (kA)	5	5 / 10	5 / 10 / 20	10	150
Wechselstrom / AC Discharge (A)	5	5 / 10	5 / 10 / 20	20	100
Bedrahtung/ lead wire	Axial	Axial	Axial		Axial
Katalogseite / catalogue page	95	95	96	96	97

Bemessungswerte/ Ratings	Gasentladungsableiter / Gas Discharge Tube				
Produktfoto / product picture					
Bauform / construction	3 polig 3 electrode	3 polig 3 electrode	3 polig 3 electrode	3 polig 3 electrode	3 polig 3 electrode
Typ / type	BM 650.000	BMS 660.000	BM CMS 670.000	BT 680.000	BT 10 690.000
Ansprechspannung / breakdown voltage (V)	90 - 550	90 - 550	90 - 550	90 - 700	230 - 420
Dynamik (1kV/μs)	<700 - <1.200	<700 - <1.200	<700 - <1.200	<700 - <1.200	< 700 - <1.200
Löschspannung / holdover voltage (V)	>60 / >80	>60 / >80	>60 / >80	>70 / > 80	>80
Stoßstrom/ discharge current (kA)	10	10	10	10 / 20	20
Wechselstrom / AC Discharge (A)	10	10	10	10 / 20	20
Bedrahtung/ lead wire	Kurzschluss / fail safe Axial	Kurzschluss / fail safe Axial / Radial		Kurzschluss / fail safe Axial / Radial	Kurzschluss / fail safe
Katalogseite / catalogue page	97	98	98	99	99

Gasableiter

No. 600.000

Gas Discharge Tube

BA

2 polig

2 electrode



Keramisch 2polig
Isolationswiderstand 100 V DC: > 1G Ω
Kapazität 1MHz (pF) : < 1
Bogenbrennungsspannung: ≤ 25 V
Bedrahtung: Axial

2 Electrode Gas Discharge Tube
Insulation Resistance: 1G Ω
Capacitance 1MHz (pF): < 1
Arc Voltage: ≤ 25 V
Lead Wire: Axial

Bestell/ Order Nr.: 600.000

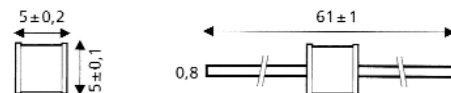

Bemessungswerte / Ratings:

Art.-No.	Ansprechspannung / Breakdown Voltage			Löschspannung Holdover Voltage (V)	Stoßstrom Discharge Current (8/20 μs)	Wechselstrom AC Discharge (A)
	Nominal (V)	Toleranz (%)	Dynamik (1kV/μs)			
600.090	90	+/- 20	< 700 V	> 60	5 kA	5
600.230	230	+/- 20	< 700 V	> 80	5 kA	5
600.350	350	+/- 20	< 900 V	> 80	5 kA	5
600.550	550	+/- 20	< 1200 V	> 80	5 kA	5

Gasableiter

No. 610.000

Gas Discharge Tube

BB

2 polig

2 electrode



Keramisch 2polig
Isolationswiderstand 100 V DC: > 1GΩ
Kapazität 1MHz (pF) : < 1
Bogenbrennungsspannung: ≤ 25 V
Bedrahtung: Axial

2 Electrode Gas Discharge Tube
Insulation Resistance: 1G Ω
Capacitance 1MHz (pF): < 1
Arc Voltage: ≤ 25 V
Lead Wire: Axial

Bestell/ Order Nr.: 610.000

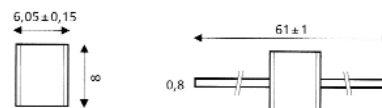

Bemessungswerte / Ratings

Art.-No.	Ansprechspannung / Breakdown Voltage			Löschspannung Holdover Voltage (V)	Stoßstrom Discharge Current (8/20 μs)	Wechselstrom AC Discharge (A)
	Nominal (V)	Toleranz (%)	Dynamik (1kV/μs)			
610.075	75	+/- 25	< 700 V	> 60	10 kA	10
610.090	90	+/- 20	< 700 V	> 60	10 kA	10
610.150	150	+/- 20	< 700 V	> 80	10 kA	10
610.230	230	+/- 15	< 750 V	> 80	10 kA	10
610.350	350	+/- 20	< 900 V	> 80	5 kA	5
610.420	420	+/- 20	< 1000 V	> 80	5 kA	5
610.550	550	+/- 20	< 1200 V	> 80	5 kA	5

Alle Gasableiter ohne radioaktive Elemente / All our products are radioactive free.

Gasableiter

No. 620.000

Gas Discharge Tube

BH

2 polig

2 electrode



Keramisch 2polig
Isolationswiderstand 100 V DC: > 1G Ω
Kapazität 1MHz (pF) : < 1
Bogenbrennspannung: \leq 25 V
Bedrhtung: Axial

2 Electrode Gas Discharge Tube
Insulation Resistance: 1G Ω
Capacitance 1MHz (pF) : < 1
Arc Voltage: \leq 25 V
Lead Wire: Axial

Bestell/ Order Nr.: 620.000

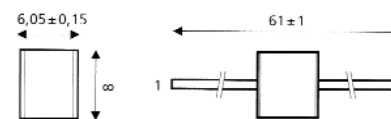

Bemessungswerte / Ratings

Art.-No.	Ansprechspannung / Breakdown Voltage			Lschspannung Holdover Voltage (V)	Stostrom Discharge Current (8/20 μ s)	Wechselstrom AC Discharge (A)
	Nominal (V)	Toleranz (%)	Dynamik (1kV/ μ s)			
620.090	90	+/- 20	< 700 V	> 80	20 kA	20
620.230	230	+/- 15	< 700 V	> 80	20 kA	20
620.350	350	+/- 20	< 900 V	> 80	10 kA	10
620.600	600	+/- 15	< 1200 V	> 80	10 kA	10
620.800	800	+/- 15	< 1400 V	> 120	5 kA	5
620.1400	1400	+/- 15	< 2000 V	> 120	5 kA	5
620.1500	1500	+/- 20	< 2000 V	> 120	5 kA	5
620.2500	2500	+/- 20	< 3800 V	> 120	5 kA	5
620.3500	3500	+/- 20	< 4600 V	> 120	5 kA	5

Gasableiter

No. 630.000

Gas Discharge Tube

CA8BC

2 polig

2 electrode



Keramisch 2polig
Isolationswiderstand 100 V DC: > 1G Ω
Kapazitt: 1MHz (pF) : < 1
Bogenbrennspannung: \leq 25 V

2 Electrode Gas Discharge Tube
Insulation Resistance: 1G Ω
Capacitance 1MHz (pF) : < 1
Arc Voltage: \leq 25 V

Bestell/ Order Nr.: 630.000

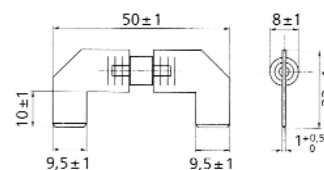

Bemessungswerte / Ratings

Art.-No.	Ansprechspannung / Breakdown Voltage			Lschspannung Holdover Voltage (V)	Stostrom Discharge Current (8/20 μ s)	Wechselstrom AC Discharge (A)
	Nominal (V)	Toleranz (%)	Dynamik (1kV/ μ s)			
630.230	230	+/- 15	< 700 V	> 80	10 kA	20
630.250	250	+/- 15	< 1000 V	> 80	10 kA	20
630.350	350	+/- 15	< 1000 V	> 80	10 kA	20
630.540	540	+/- 15	< 1200 V	> 80	10 kA	20



Alle Gasableiter ohne radioaktive Elemente / All our products are radioactive free.

Gasableiter

No. 640.000

Gas Discharge Tube

P 100

Glas / Metall

glass / metal

ESKA



Glas / Metall
Isolationswiderstand 100 V DC: > 1G Ω
Kapazität 1MHz (pF): < 10
Bogenbrennspannung: \leq 25 V
Bedrahtung: Axial

Glass / Metal
Insulation Resistance: 10 G Ω
Capacitance 1MHz (pF): < 1
Arc Voltage: \leq 25 V
Lead Wire: Axial

Bestell/ Order Nr.: 640.000

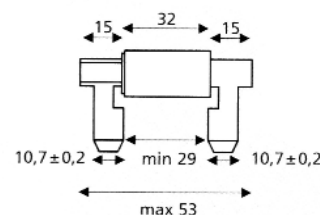

Bemessungswerte / Ratings

Art.-No.	Ansprechspannung / Breakdown Voltage			Löschspannung Holdover Voltage (V)	Stoßstrom Discharge Current (8/20 μ s)	Wechselstrom AC Discharge (A)
	Nominal (V)	Toleranz (%)	Dynamik (1kV/ μ s)			
640.150	150	+/- 20	< 700 V	> 80	150 kA	100 A
640.250	250	+/- 20	< 900 V	> 80	150 kA	100 A
640.350	350	+/- 20	< 1000 V	> 80	150 kA	100 A
640.500	500	+/- 20	< 1200 V	> 80	150 kA	100 A
640.750	750	+/- 20	< 1600 V	> 80	150 kA	100 A

Gasableiter

No. 650.000

Gas Discharge Tube

BM

3 polig

3 electrode



Keramisch 3polig
Isolationswiderstand 100 V DC: > 1G Ω
Kapazität: 1MHz (pF) : < 2
Bogenbrennspannung: \leq 25 V
Bedrahtung: Axial
Kurzschluss: c

3 Electrode Gas Discharge Tube
Insulation Resistance: 1G Ω
Capacitance 1MHz (pF): < 2
Arc Voltage: \leq 25 V
Lead Wire: Axial
Fail Safe: c

Bestell/ Order Nr.: 650.000

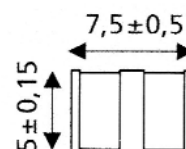

Bemessungswerte / Ratings

Art.-No.	Ansprechspannung / Breakdown Voltage			Löschspannung Holdover Voltage (V)	Stoßstrom Discharge Current (8/20 μ s)	Wechselstrom AC Discharge (A)
	Nominal (V)	Toleranz (%)	Dynamik (1kV/ μ s)			
650.090	90	+/- 20	< 700 V	> 60	10 kA	10
650.230	230	+/- 20	< 800 V	> 80	10 kA	10
650.350	350	+/- 20	< 1100 V	> 80	10 kA	10
650.420	420	+/- 20	< 1200 V	> 80	10 kA	10
650.550	550	+/- 20	< 1200 V	> 80	10 kA	10

Alle Gasableiter ohne radioaktive Elemente / All our products are radioactive free.

Gasableiter

No. 660.000

Gas Discharge Tube

BMS

3 polig

3 electrode

ESKA



Keramisch 3polig
Isolationswiderstand 100 V DC: > 1G Ω
Kapazität: 1MHz (pF) : < 2
Bogenbrennspannung: \leq 25 V
Bedrahtung: Axial, Radial
Kurzschluss: c

3 Electrode Gas Discharge Tube
Insulation Resistance: 1G Ω
Capacitance 1MHz (pF): < 2
Arc Voltage: \leq 25 V
Lead Wire: Axial, Radial
Fail Safe: c

Bestell/ Order Nr.: 660.000

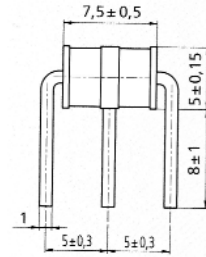

Bemessungswerte / Ratings

Art.- No.	Ansprechspannung / Breakdown Voltage			Löschspannung Holdover Voltage (V)	Stoßstrom Discharge Current (8/20 μ s)	Wechselstrom AC Discharge (A)
	Nominal (V)	Toleranz (%)	Dynamik (1kV/ μ s)			
660.090	90	+/- 20	< 700 V	> 60	10 kA	10 A
660.230	230	+/- 20	< 800 V	> 80	10 kA	10 A
660.350	350	+/- 20	< 1100 V	> 80	10 kA	10 A
660.420	420	+/- 20	< 1200 V	> 80	10 kA	10 A
660.550	550	+/- 20	< 1200 V	> 80	10 kA	10 A

Gasableiter

No. 670.000

Gas Discharge Tube

BM CMS

3 polig

3 electrode



Keramisch 3polig
Isolationswiderstand 100 V DC: > 1G Ω
Kapazität: 1MHz (pF) : < 2
Bogenbrennspannung: \leq 25 V

3 Electrode Gas Discharge Tube
Insulation Resistance: 1G Ω
Capacitance 1MHz (pF): < 2
Arc Voltage: \leq 25 V

Bestell/ Order Nr.: 670.000

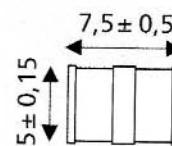

Bemessungswerte / Ratings

Art.- No.	Ansprechspannung / Breakdown Voltage			Löschspannung Holdover Voltage (V)	Stoßstrom Discharge Current (8/20 μ s)	Wechselstrom AC Discharge (A)
	Nominal (V)	Toleranz (%)	Dynamik (1kV/ μ s)			
670.090	90	+/- 20	< 700 V	> 60	10 kA	10
670.230	230	+/- 20	< 800 V	> 80	10 kA	10
670.350	350	+/- 20	< 1100 V	> 80	10 kA	10
670.420	420	+/- 20	< 1200 V	> 80	10 kA	10
670.550	550	+/- 20	< 1200 V	> 80	10 kA	10



Alle Gasableiter ohne radioaktive Elemente / All our products are radioactive free.

Gasableiter

No. 680.000

Gas Discharge Tube

BT

3 polig

3 electrode

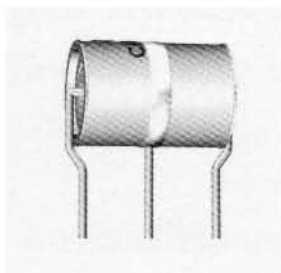

Keramisch 3polig
Isolationswiderstand 100 V DC: > 1G Ω
Kapazität: 1MHz (pF): < 2
Bogenbrennspannung: ≤ 25 V
Bedrahtung: Axial, Radial
Kurzschluss: c

3 Electrode Gas Discharge Tube
Insulation Resistance: 1G Ω
Capacitance 1MHz (pF): < 2
Arc Voltage: ≤ 25 V
Lead Wire: Axial, Radial
Fail Safe: c

Bestell/ Order Nr.: 680.000

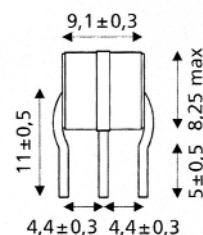

Bemessungswerte / Ratings

Art.-No.	Ansprechspannung / Breakdown Voltage			Löschspannung Holdover Voltage (V)	Stoßstrom Discharge Current (8/20 μs)	Wechselstrom AC Discharge (A)
	Nominal (V)	Toleranz (%)	Dynamik (1kV/μs)			
680.090	90	+/- 20	< 700 V	> 70	20 kA	20 A
680.230	230	+/- 20	< 800 V	> 80	20 kA	20 A
680.350	350	+/- 20	< 1100 V	> 80	20 kA	20 A
680.470	470	+/- 20	< 1150 V	> 80	10 kA	10 A
680.550	550	+/- 20	< 1200 V	> 80	10 kA	10 A
680.700	700	+/- 20	< 1200 V	> 80	10 kA	10 A

Gasableiter

No. 690.000

Gas Discharge Tube

BT 10

3 polig

3 electrode



Keramisch 3polig
Isolationswiderstand 100 V DC: > 1G Ω
Kapazität: 1MHz (pF): < 5
Bogenbrennspannung: ≤ 20 V
Kurzschluss: c

3 Electrode Gas Discharge Tube
Insulation Resistance: 1G Ω
Capacitance 1MHz (pF): < 5
Arc Voltage: ≤ 20 V
Fail Safe: c

Bestell/ Order Nr.: 690.000

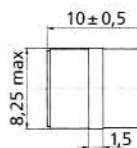

Bemessungswerte / Ratings

Art.-No.	Ansprechspannung / Breakdown Voltage			Löschspannung Holdover Voltage (V)	Stoßstrom Discharge Current (8/20 μs)	Wechselstrom AC Discharge (A)
	Nominal (V)	Toleranz (%)	Dynamik (1kV/μs)			
690.230	230	+/- 15	< 700 V	> 80	20 kA	20
690.250	250	+/- 20	< 700 V	> 80	20 kA	20
690.260	260	+/- 20	< 700 V	> 80	20 kA	20
690.350	350	+/- 20	< 1000 V	> 80	20 kA	20
690.420	420	+/- 17	< 1200 V	> 80	20 kA	20

Alle Gasableiter ohne radioaktive Elemente / All our products are radioactive free.

Bemessungswerte/ Ratings	KFZ-Sicherung / Car Fuses			
Produktfoto / product picture				
Typ / type	Mini 341.100	Standard 340.000	Maxi 343.400	ATS 300.000
Strom / current	2 A – 30 A	1 A – 40 A	30 A – 100 A	5 A – 25 A
Spannung / voltage	32 V	32 V	32 V	36 V
Ausschaltvermögen / breaking capacity	1.000 A	1.000	1.000	Auf Anfrage / on request
RoHS				
Norm	ISO 8820-3	ISO 8820-3	ISO 8820-3	DIN 72581/1

Bemessungswerte/ Ratings	KFZ-Sicherung / Car Fuses			
Produktfoto / product picture				
Typ / type	Midi 341.400	Mega 341.300	Power 341.500	Streifen ZN 341.200
Strom / current	30 A – 125A	100 A – 250A	Cal. 1 – Cal. 4	30 A – 100 A
Spannung / voltage	32 V	32 V	32 V	32 V
Ausschaltvermögen / breaking capacity	1.000 A	1.000 A	2.000 A	1.000 A
RoHS				
Norm	ISO 8820-5	ISO 8820-5	Renault 36-05-805	DIN 72581/2

Anwendungsbereiche / Typical Applications	Automobilelektrik und – elektronik Motorensteuerung Klimaanlage Automatikgetriebe Starter- und Zündanlagen Elektrische Sitz- und Spiegelverstellung Lichtmaschinen Schiffbautechnologie Allgemeine Industrieanwendungen Lichttechnik	Automobilelectric- and electronic Motor control center Air condition Automatic gearbox Ignitionsystems Electrical seat- and mirrorshift Generators Ship building industry General industrial applications Light technology
--	---	---









Weitere Informationen können Sie unserem Sonderkatalog "Automotive" entnehmen.









Bemessungswerte/ Ratings	Temperatursicherungen / Thermal cutoffs				
Produktfoto / product picture					
Typ / type	E 4	E 5	E 6	E 7	E 8
Bauform / construction	axial	axial	axial	axial	axial
Bemessungstemperatur/ calibration Range C°	70 – 240	70 - 240	70 – 240	70 – 205	70 – 240
Strom / current max.	10 A	16 A	16 A	5 A	25 A
Spannung / voltage	250 V	250 V	250 V	250 V	250 V
Beschreibung / description	Nicht rückstellbar One-Shot Thermal Fuse	Nicht rückstellbar One-Shot Thermal Fuse	Nicht rückstellbar One-Shot Thermal Fuse	Nicht rückstellbar One-Shot Thermal Fuse	Nicht rückstellbar One-Shot Thermal Fuse
RoHS	*	*	*	*	*
Prüfzeichen / approvals	IEC 691 / EN60691 VDE/DIN EN 60691 UL E40667 CSA / LR26323	IEC 691 / EN60691 VDE/DIN EN 60691 UL E40667 CSA / LR26323	IEC 691 / EN60691 VDE/DIN EN 60691 UL E40667 CSA / LR26323	IEC 691 / EN60691 VDE/DIN EN 60691 UL E40667 CSA / LR26323	IEC 691 / EN60691 VDE/DIN EN 60691 UL E40667 CSA / LR26323







Bemessungswerte/ Ratings	Temperatursicherungen / Thermal cutoffs						
Produktfoto / product picture							
Typ / type	N	H	E	K	T	V	Y
Bauform / construction	radial	radial	radial	axial	axial	axial	axial
Bemessungstemperatur / calibration Range C°	65 – 169	65 – 169	65 – 169	65 - 145	65 - 169	65 - 187	65 - 145
Strom / current max.	1 A	2 A	3 A	1 A	1 A	3 A	5 A
Spannung / voltage max.	250 V	250 V	250 V	250 V	250 V	250 V	250 V
Beschreibung / description	Nicht rückstellbar One-Shot Thermal Fuse	Nicht rückstellbar One-Shot Thermal Fuse	Nicht rückstellbar One-Shot Thermal Fuse	Nicht rückstellbar One-Shot Thermal Fuse	Nicht rückstellbar One-Shot Thermal Fuse	Nicht rückstellbar One-Shot Thermal Fuse	Nicht rückstellbar One-Shot Thermal Fuse
RoHS	*	*	*	*	*	*	*
Prüfzeichen / approvals	UL / C-UL CCC / VDE BEAB	UL / C-UL CCC / VDE BEAB	UL / C-UL CCC / VDE BEAB	UL / C-UL CCC / VDE BEAB	UL / C-UL CCC / VDE BEAB	UL / C-UL CCC / VDE BEAB	UL / C-UL CCC / VDE BEAB





Anwendungsbereiche / Typical Applications	Elektrische Heizgeräte, Klimaanlage, Haushaltsgeräte, Transformatoren, Zentralheizungen, Solaranlagen, Akkumulatoren, Automotive Medizintechnik, Labortechnik Steuer- und Meßtechnik	Electric Heating & Air Conditioning Household appliances, Transformers, Central heatings, Solar installations, Accumulators, Automotive, Medical technology, Laboratories Control & Measuring Technics
--	--	--







Im Bereich Temperaturschutz sind auch Temperaturschalter in den verschiedensten Bauformen erhältlich. Informationen zu diesen speziellen Schaltern entnehmen Sie bitte unserem Sonderkatalog "Temperature".







Technische Daten / Technical specifications	Sicherungshalter / Fuse – holders			
Produktfoto / product picture				
Typ / type	5 x 20 601.100	5 x 20 601.800	5 x 20 502.630	5 x 20 502.610
Strom / current	6,3 A	10 A	10 A / 6,3 A	6,3 A
Spannung / voltage	250 V	250 V	250 V	250 V
Übergangswiderstand / contact resistance	< 5 m	< 5 m	< 5 m	< 5 m
Isolationswiderstand / Insulation resistance	> 100 M	> 100 M	> 100 M	> 100 M
Durchschlagsfestigkeit / dielectric strength	> 3000 Vac/60s	> 1500 Vac/ 60s	> 4000 Vac/ 60s	> 3000 Vac/ 60s
Prüfzeichen / approvals				
Katalogseite / catalogue page	106	106	106	107









Technische Daten / Technical specifications	Sicherungshalter / Fuse – holders			
Produktfoto / product picture				
Typ / type	5 x 20 502.910	5 x 20 502.710	5 x 20 502.730	5 x 20 502.840
Strom / current	6,3 A	6,3 A	10 A	6,3 A
Spannung / voltage	250 V	250 V	250 V	250 V
Übergangswiderstand / contact resistance	< 5 m	< 5 m	< 5 m	< 5 m
Isolationswiderstand / Insulation resistance	> 100 M	> 100 M	> 100 M	> 100 M
Durchschlagsfestigkeit / dielectric strength	> 3000 Vac/60s	> 3000 Vac/60s	4000 Vac/60s	> 3000 Vac/60s
Prüfzeichen / approvals				
Katalogseite / catalogue page	107	107	108	108









Technische Daten / Technical specifications	Sicherungshalter / Fuse – holders			
	Produktfoto / product picture			
Typ / type	5 x 20 502.810	5 x 20 502.010	5 x 25 502.510	Schraubkappen / screw caps
Strom / current	6,3 A	6,3 A	6,3 A	
Spannung / voltage	250 V	250 V	250 V	
Übergangswiderstand / contact resistance	< 5 m			
Isolationswiderstand / Insulation resistance	> 100 M			
Durchschlagsfestigkeit / dielectric strength	> 3000 Vac/60s			
Prüfzeichen / approvals				
Katalogseite / catalogue page	108	109	109	109

Technische Daten / Technical specifications	Sicherungshalter / Fuse – holders			
	Produktfoto / product picture			
Typ / type	5 x 20 502.830	5 x 20 502.740	5 x 20 FX 0357 / FX 0359	5 x 20 FX 0367 / FX 0369
Strom / current	10 A	10 A	10 A	10 A
Spannung / voltage	250 V	250 V	250 V	250 V
Übergangswiderstand / contact resistance	< 5 m	< 5 m	< 10 m	< 10 m
Isolationswiderstand / Insulation resistance	> 100 M	auf Anfrage/ on request	> 100 M	> 100 M
Durchschlagsfestigkeit / dielectric strength	> 4000 Vac/60s	auf Anfrage/ on request	7 kV @ 50 HZ	7 kV @ 50 HZ
Prüfzeichen / approvals				
Katalogseite / catalogue page	110	110	110	111

Technische Daten / Technical specifications	Sicherungshalter / Fuse – holders			
	Produktfoto / product picture			
Typ / type	5 x 20 FX 0454 / FX 0455	5 x 20 FX 0454S / FX 0455S	5 x 20 FX 0458	5 x 20 FX 0457 / FX 0456
Strom / current	10 A	10 A	10 A	10 A
Spannung / voltage	250 V	250 V	250 V	250 V
Übergangswiderstand / contact resistance	< 10 m	< 10 m	< 10 m	< 10 m
Isolationswiderstand / Insulation resistance	> 100 M	> 100 M	> 100 M	> 100 M
Durchschlagsfestigkeit / dielectric strength	7 kV @ 50Hz	7 kV @ 50Hz	7 kV @ 50Hz	4 kV @ 50Hz
Prüfzeichen / approvals				
Katalogseite / catalogue page	111	111	112	112

Technische Daten / Technical specifications	Sicherungshalter / Fuse – holders			
	Produktfoto / product picture			
Typ / type	5 x 20 FX 0430	6,3 x 32 602.400	6,3 x 32 602.000	6,3 x 32 FX 0418
Strom / current	10 A	15 A	15 A	16 A
Spannung / voltage	250 V	250 V	250 V	250 V
Übergangswiderstand / contact resistance	< 10 m	< 5 m	< 5 m	< 10 m
Isolationswiderstand / Insulation resistance	> 10 M	> 100 M	> 100 M	> 10 ⁶ M
Durchschlagsfestigkeit / dielectric strength	> 2 kV	> 1500 Vac/60s	> 1500 Vac/60s	> 2 kV
Prüfzeichen / approvals				
Katalogseite / catalogue page	112	113	113	113

Technische Daten / Technical specifications	Sicherungshalter / Fuse – holders			
Produktfoto / product picture				
Typ / type	6,3 x 32 FX 0415 / FX 0416	6,3 x 32 FX 0415S / FX 0416S	6,3 x 32 FX 0417	10,3 x 38,1 1038.215
Strom / current	13 A	13 A	16 A	30 A
Spannung / voltage	250 V	250 V	250 V	600 V
Übergangswiderstand / contact resistance	< 5 m	< 5 m	< 10 m	< 5 m
Isolationswiderstand / Insulation resistance	> 10 ⁵ M	> 10 ⁵ M	> 10 ⁶ M	> 100 M
Durchschlagsfestigkeit / dielectric strength	4 kV @ 50Hz	4 kV @ 50Hz	> 2 kV	3000 V/60s
Prüfzeichen / approvals				
Katalogseite / catalogue page	114	114	114	115

Technische Daten / Technical specifications	Sicherungshalter / Fuse – holders			
Produktfoto / product picture				
Typ / type	5x20 / 6,3x25 / 6,3x32 FX0380 / FX0280 / FX0180	5x20 / 6,3x25 / 6,3x32 FX0385 / FX0285 / FX0185	UMF 920.000	Socket / socket 886.000
Strom / current	10 A	10 A	6,3 A	6,3 A
Spannung / voltage	250 V	250 V	250 V	250 V
Übergangswiderstand / contact resistance	< 10 m	< 10 m	auf Anfrage / on request	< 4,3 m
Isolationswiderstand / Insulation resistance	> 10 ⁵ M	> 10 ⁵ M	auf Anfrage / on request	> 100 M
Durchschlagsfestigkeit / dielectric strength	2 kV	2 kV	auf Anfrage / on request	> 3000 Vac/60s
Prüfzeichen / approvals				
Katalogseite / catalogue page	115	115	116	116

G-Sicherungshalter 5 x 20 mm

601.100 / 601.800 / 502.630

Fuse-holders



G-Sicherungshalter für Sicherungen / für 5 x 20 mm mit Schraubkappe

Bemessungsstrom: 6,3 A
Bemessungsspannung: 250 V
Übergangswiderstand: < 5 m
Isolationswiderstand: > 100 M
Durchschlagsfestigkeit: > 3000 Vac/60s

Fuse-holder for fuses for 5 x 20 mm with screw cap
Nominal current: 6,3 A
Voltage: 250 V
Contact resistance: < 5 m
Insulation resistance: 100 M
Dielectric strength: > 3000 Vac/60s

Bestell/ Order Nr.: 601.100
6011 EL

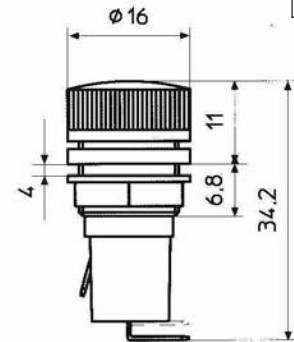

G-Sicherungshalter für Sicherungen / für 5 x 20 mm mit Schraubkappe

Bemessungsstrom: 10 A
Bemessungsspannung: 250 V
Übergangswiderstand: < 5 m
Isolationswiderstand: > 100 M
Durchschlagsfestigkeit: > 1500 Vac/60s

Fuse-holder for fuses for 5 x 20 mm with screw cap
Nominal current: 10 A
Voltage: 250 V
Contact resistance: < 5 m
Insulation resistance: 100 M
Dielectric strength: > 1500 Vac/60s

Bestell/ Order Nr.: 601.800
6018 ED

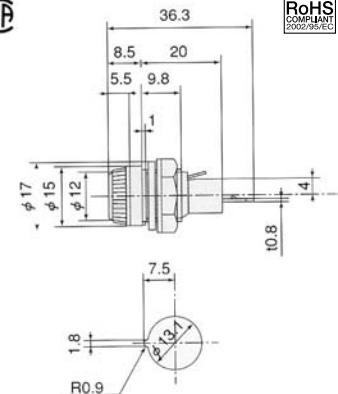

G-Sicherungshalter für Sicherungen / für 5 x 20 mm mit Renkverschlußkappe

Bemessungsstrom: 10 A
Bemessungsstrom: 6,3 A (Semko)
Bemessungsspannung: 250 V
Übergangswiderstand: < 5 m
Isolationswiderstand: > 100 M
Durchschlagsfestigkeit: > 4000 Vac/60s

Fuse-holder for fuses for 5 x 20 mm with bayonet cap
Nominal current: 10 A
Nominal current: 6,3 A (Semko)
Voltage: 250 V
Contact resistance: < 5 m
Insulation resistance: 100 M
Dielectric strength: > 4000 Vac/60s

Bestell/ Order Nr.: 502.630
5026 ED

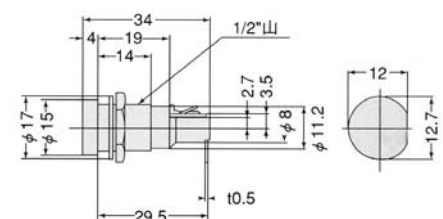

G-Sicherungshalter 5 x 20 mm

502.610 / 502.910 / 502.710

Fuse-holders



G-Sicherungshalter für Sicherungen / für 5 x 20 mm mit Schraubkappe

Bemessungsstrom: 6,3 A
Bemessungsspannung: 250 V
Verlustleistung: 2,5 W
Übergangswiderstand: < 5m
Isolationswiderstand: > 100 M
Durchschlagsfestigkeit: > 3000 Vac/60s

Fuse-holder for fuses for 5 x 20 mm with screw cap
Nominal current: 6,3 A
Voltage: 250 V
Sustained dissipation: 2,5 W
Contact resistance: < 5m
Insulation resistance: 100 M
Dielectric strength: > 3000 Vac/60s

Bestell/ Order Nr.: 502.610

5026 EL

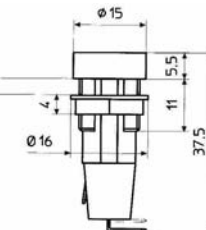

G-Sicherungshalter für Sicherungen / für 5 x 20 mm mit Renkverschlußkappe

Bemessungsstrom: 6,3 A
Bemessungsspannung: 250 V
Übergangswiderstand: < 5m
Isolationswiderstand: > 100 M
Durchschlagsfestigkeit: > 3000 Vac/60s

Fuse-holder for fuses for 5 x 20 mm with bayonet cap
Nominal current: 6,3 A
Voltage: 250 V
Contact resistance: < 5m
Insulation resistance: 100 M
Dielectric strength: > 3000 Vac/60s

Bestell/ Order Nr.: 502.910

5029 FI

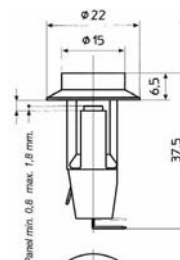

G-Sicherungshalter für Sicherungen / für 5 x 20 mm mit Renkverschlußkappe

Bemessungsstrom: 6,3 A
Bemessungsspannung: 250 V
Verlustleistung: 2,5 W
Übergangswiderstand: < 5m
Isolationswiderstand: > 100 M
Durchschlagsfestigkeit: > 3000 Vac/60s

Fuse-holder for fuses for 5 x 20 mm with bayonet cap
Nominal current: 6,3 A
Voltage: 250 V
Sustained dissipation: 2,5 W
Contact resistance: < 5m
Insulation resistance: 100 M
Dielectric strength: > 3000 Vac/60s

Bestell/ Order Nr.: 502.710

5027 EL

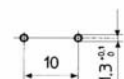
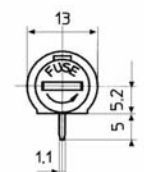
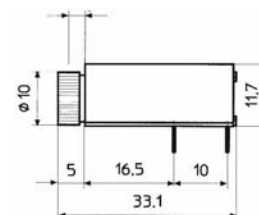

G-Sicherungshalter 5 x 20 mm

502.730 / 502.840 / 502.810

Fuse-holders



G-Sicherungshalter für Sicherungen / für 5 x 20 mm mit Renkverschlußkappe

Bemessungsstrom: 10 A
Bemessungsspannung: 250 V
Übergangswiderstand: < 5m
Isolationswiderstand: 100 M
Durchschlagsfestigkeit: 4000 Vac/60s

Fuse-holder for fuses for 5 x 20 mm with bayonet cap

Nominal current: 10 A
Voltage: 250 V
Contact resistance: < 5m
Insulation resistance: 100 M
Dielectric strength: 4000 Vac/60s

Bestell/ Order Nr.: 502.730
5027 ED

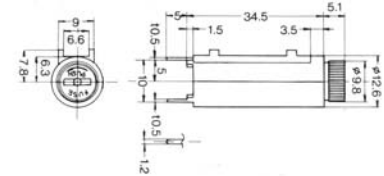

G-Sicherungshalter für Sicherungen / für 5 x 20 mm mit Renkverschlußkappe

Bemessungsstrom: 6,3 A
Bemessungsspannung: 250 V
Pinabstand: 7,5 mm

Fuse-holder for fuses for 5 x 20 mm with bayonet cap

Nominal current: 6,3 A
Voltage: 250 V
Pin distance: 7,5 mm

Bestell/ Order Nr.: 502.840
5028

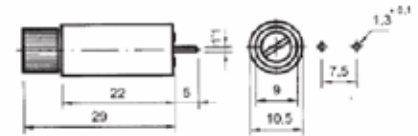

G-Sicherungshalter für Sicherungen / für 5 x 20 mm mit Renkverschlußkappe

Bemessungsstrom: 6,3 A
Bemessungsspannung: 250 V
Verlustleistung: 2,5 W
Übergangswiderstand: < 5m
Isolationswiderstand: > 100 M
Durchschlagsfestigkeit: > 3000 Vac/60s

Fuse-holder for fuses for 5 x 20 mm with bayonet cap

Nominal current: 6,3 A
Voltage: 250 V
Sustained dissipation: 2,5 W
Contact resistance: < 5m
Insulation resistance: >100 M
Dielectric strength: > 3000 Vac/60s

Bestell/ Order Nr.: 502.810
5028 EL

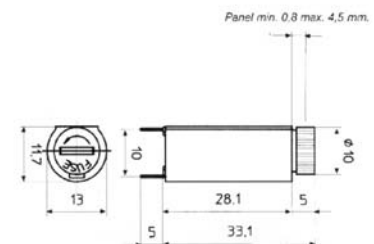

G-Sicherungshalter 5 x 20 mm

502.010 / 502.510 / Schraubkappen

Fuse-holders + Screw caps

ESKA



G-Sicherungshalter für Sicherungen /
für 5 x 20 mm
Gewinde: PG 11
Bemessungsstrom: 6,3 A
Bemessungsspannung: 250 V

Fuse-holder for fuses
for 5 x 20 mm
Thread: PG 11
Nominal current: 6,3 A
Voltage: 250 V

Schraubkappen / screw caps¹⁾:

5021
5022
5023

Bestell/ Order Nr.: 502.010
B 5020
DIN 41672

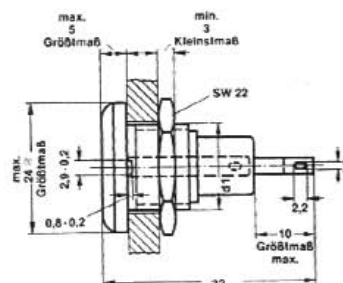

G-Sicherungshalter für Sicherungen /
für 5 x 25 mm
Gewinde: PG 11
Bemessungsstrom: 6,3 A
Bemessungsspannung: 250 V

Fuse-holder for fuses
for 5 x 25 mm
Thread: PG 11
Nominal current: 6,3 A
Voltage: 250 V

Schraubkappen / screw caps¹⁾:

5021
5022
5023

Bestell/ Order Nr.: 502.510
B 5025
DIN 41672

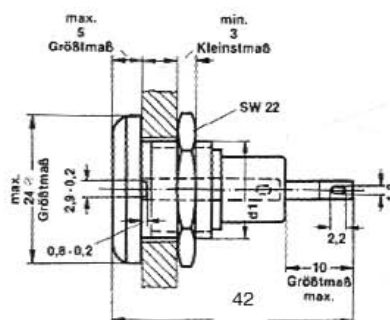

G-Schraubkappen für Sicherungshalter
Screw caps for fuse-holders

5021: glatt / plain

5022: mit Fenster / with glass

5023: mit Schlitz für Schraubendreher /
with screw-driver-slot

Bestell/ Order Nr.:
502.100/ 502.200/ 502.300
5021 / 5022 / 5023



1) nicht enthalten / not included

G-Sicherungshalter 5 x 20 mm

502.830 + 502.740 / FX 0357 + FX 0359

Fuse-holders



G-Sicherungshalter für Sicherungen / für 5 x 20 mm mit Renkverschlußkappe

Bemessungsstrom: 10 A
Bemessungsspannung: 250 V
Übergangswiderstand: < 5m
Isolationswiderstand: >100 M
Durchschlagsfestigkeit: 4000 Vac/60s

Fuse-holder for fuses for 5 x 20 mm with bayonet cap
Nominal current: 10 A
Voltage: 250 V
Contact resistance: < 5m
Insulation resistance: >100 M
Dielectric strength: 4000 Vac/60s

Bestell/ Order Nr.: 502.830
5028 ED

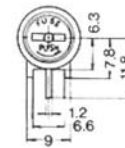
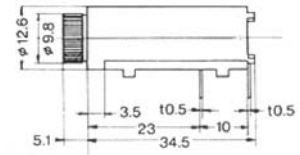

G-Sicherungshalter für Sicherungen / für 5 x 20 mm mit Renkverschlußkappe

Bemessungsstrom: 10 A
Bemessungsspannung: 250 V
Übergangswiderstand: < 5m

Fuse-holder for fuses for 5 x 20 mm with bayonet cap
Nominal current: 10 A
Voltage: 250 V
Contact resistance: < 5m

Bestell/ Order Nr.: 502.740
5027 S

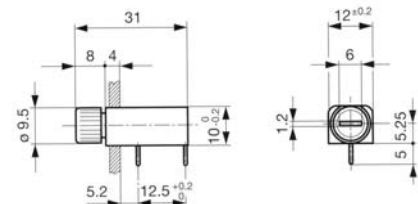

G-Sicherungshalter für Sicherungen / für 5 x 20 mm mit Renkverschlußkappe

Bemessungsstrom: 10 A
Bemessungsspannung: 250 V
Ausgangsleistung: 2,5 W (@ 23 °C)
Übergangswiderstand: < 10 m
Isolationswiderstand: > 10² M @ 500 V d.c
Durchschlagsfestigkeit: 7 kV @ 50Hz

Fuse-holder for fuses for 5 x 20 mm with bayonet cap
Nominal current: 10 A
Voltage: 250 V
Operating power: 2,5 W (@ 23 °C)
Contact resistance: < 10 m
Insulation resistance: > 10² M @ 500 V d.c
A.C Breakdown: 7 kV @ 50Hz

Bestell/ Order Nr.: FX 0357 / FX 0359

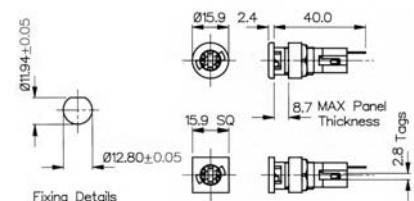

G-Sicherungshalter 5 x 20 mm

FX 0367 + FX 0369 / FX0454 + FX 0455 /

FX 0454S + FX 0455S Fuse-holders

ESKA



G-Sicherungshalter für Sicherungen / für 5 x 20 mm mit Renkverschlußkappe

Bemessungsstrom: 10 A
Bemessungsspannung: 250 V
Verlustleistung: 2,5 W (@ 23 °C)
Übergangswiderstand: < 10 m
Isolationswiderstand: > 10² M @ 500 V d.c
Durchschlagsfestigkeit: 7 kV @ 50Hz

Fuse-holder for fuses for 5 x 20 mm with bayonet cap
Nominal current: 10 A
Voltage: 250 V
Sustained dissipation: 2,5 W (@ 23 °C)
Contact resistance: < 10 m
Insulation resistance: > 10² M @ 500 V d.c
A.C Breakdown: 7 kV @ 50Hz

Bestell/ Order Nr.: FX 0367
FX 0369

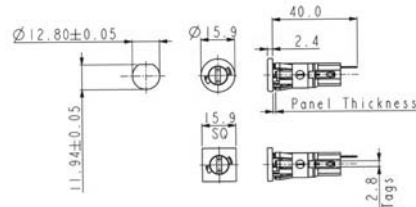

G-Sicherungshalter für Sicherungen / für 5 x 20 mm mit Schraubkappe

Bemessungsstrom: 10 A
Bemessungsspannung: 250 V
Verlustleistung: 2,5 W (@ 23 °C)
Übergangswiderstand: < 10 m
Isolationswiderstand: > 10² M @ 500 V d.c
Durchschlagsfestigkeit: 7 kV @ 50Hz

Fuse-holder for fuses for 5 x 20 mm with screw cap
Nominal current: 10 A
Voltage: 250 V
Sustained dissipation: 2,5 W (@ 23 °C)
Contact resistance: < 10 m
Insulation resistance: > 10² M @ 500 V d.c
A.C Breakdown: 7 kV @ 50Hz

Bestell/ Order Nr.: FX 0454
FX 0455

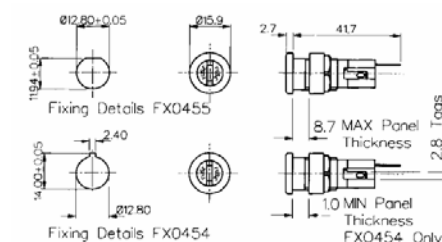

G-Sicherungshalter für Sicherungen / für 5 x 20 mm mit Schraubkappe

Bemessungsstrom: 10 A
Bemessungsspannung: 250 V
Verlustleistung: 2,5 W (@ 23 °C)
Übergangswiderstand: < 10 m
Isolationswiderstand: > 10² M @ 500 V d.c
Durchschlagsfestigkeit: 7 kV @ 50Hz

Fuse-holder for fuses for 5 x 20 mm with screw cap
Nominal current: 10 A
Voltage: 250 V
Sustained dissipation: 2,5 W (@ 23 °C)
Contact resistance: < 10 m
Insulation resistance: > 10² M @ 500 V d.c
A.C Breakdown: 7 kV @ 50Hz

Bestell/ Order Nr.: FX 0454/S
FX 0455/S

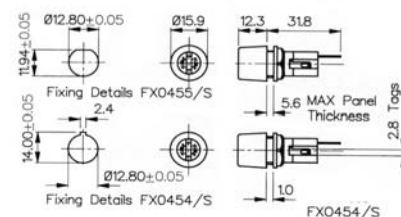

G-Sicherungshalter 5 x 20 mm

FX 0458 / FX 0457 + FX 0456 / FX 0430

Fuse-holders

ESKA



G-Sicherungshalter für Sicherungen / für 5 x 20 mm mit Schraubkappe

Bemessungsstrom: 10 A
Bemessungsspannung: 250 V
Verlustleistung: 2,5 W (@ 23 °C)
Übergangswiderstand: < 10 m
Isolationswiderstand: > 10² M @ 500 V d.c
Durchschlagsfestigkeit: 7 kV @ 50Hz

Fuse-holder for fuses for 5 x 20 mm with screw cap
Nominal current: 10 A
Voltage: 250 V
Sustained dissipation: 2,5 W (@ 23 °C)
Contact resistance: < 10 m
Insulation resistance: > 10² M @ 500 V d.c
A.C Breakdown: 7 kV @ 50Hz

Bestell/ Order Nr.: FX 0458

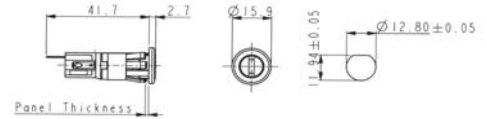

G-Sicherungshalter für Sicherungen / für 5 x 20 mm mit Renkverschlußkappe

Bemessungsstrom: 10 A
Bemessungsspannung: 250 V
Verlustleistung: 2,5 W (@ 23 °C)
Übergangswiderstand: < 10 m
Isolationswiderstand: > 10² M @ 500 V d.c
Durchschlagsfestigkeit: 4 kV @ 50Hz

Fuse-holder for fuses for 5 x 20 mm with bayonet cap
Nominal current: 10 A
Voltage: 250 V
Sustained dissipation: 2,5 W (@ 23 °C)
Contact resistance: < 10 m
Insulation resistance: > 10² M @ 500 V d.c
A.C Breakdown: 4 kV @ 50Hz

**Bestell/ Order Nr.: FX 0457
FX 0456**

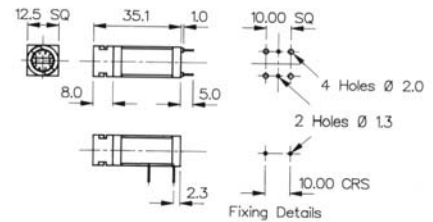

G-Sicherungshalter für Sicherungen / für 5 x 20 mm

Bemessungsstrom: 10 A
Bemessungsspannung: 250 V
Verlustleistung: 2,5 W (@ 23 °C)
Übergangswiderstand: < 10 m
Isolationswiderstand: > 10 M @ 500 V d.c
Durchschlagsfestigkeit: > 2 kV

Fuse-holder for fuses for 5 x 20 mm
Nominal current: 10 A
Voltage: 250 V
Sustained dissipation: 2,5 W (@ 23 °C)
Contact resistance: < 10 m
Insulation resistance: > 10 M @ 500 V d.c
A.C Breakdown: > 2 kV

Bestell/ Order Nr.: FX 0430

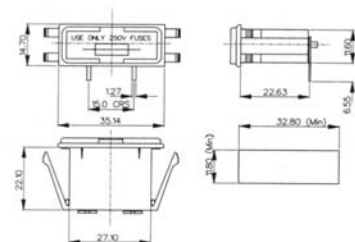

G-Sicherungshalter 6,3 x 32 mm

602.400 / 602.000 / FX 0418

Fuse-holders



G-Sicherungshalter für Sicherungen / für 6,3 x 32 mm mit Renkverschlußkappe

Bemessungsstrom: 15 A
Bemessungsspannung: 250 V
Übergangswiderstand: < 5m
Isolationswiderstand: >100 M
Durchschlagsfestigkeit: 1500 Vac/60s

Fuse-holder for fuses for 6,3 x 32 mm with bayonet cap
Nominal current: 15 A
Voltage: 250 V
Contact resistance: < 5m
Insulation resistance: >100 M
Dielectric strength: 1500 Vac/60"

Bestell/ Order Nr.: 602.400
E 6024

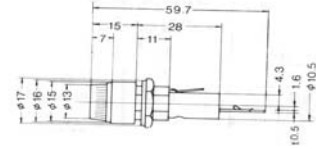

G-Sicherungshalter für Sicherungen / für 6,3 x 32 mm mit Renkverschlußkappe

Bemessungsstrom: 15 A
Bemessungsspannung: 250 V
Übergangswiderstand: < 5m
Isolationswiderstand: >100 M
Durchschlagsfestigkeit: 1500 Vac/60s

Fuse-holder for fuses for 6,3 x 32 mm with bayonet cap
Nominal current: 15 A
Voltage: 250 V
Contact resistance: < 5m
Insulation resistance: >100 M
Dielectric strength: 1500 Vac/60"

Bestell/ Order Nr.: 602.000
E 6020

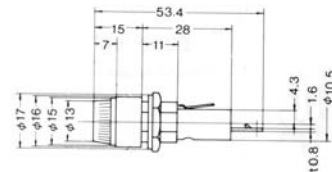

G-Sicherungshalter für Sicherungen / für 6,3 x 32 mm mit Schraubdeckel

Bemessungsstrom: 16 A
Bemessungsspannung: 250 V
Ausgangsleistung: 4 W (@ 23 °C)
Übergangswiderstand: < 10 m
Isolationswiderstand: > 10⁶ M @ 500 V d.c
Durchschlagsfestigkeit: > 2 kV

Fuse-holder for fuses for 6,3 x 32 mm with screw cap
Nominal current: 16 A
Voltage: 250 V
Operating power: 4 W (@ 23 °C)
Contact resistance: < 10 m
Insulation resistance: > 10⁶ M @ 500 V d.c
A.C Breakdown: > 2 kV

Bestell/ Order Nr.: FX 0418

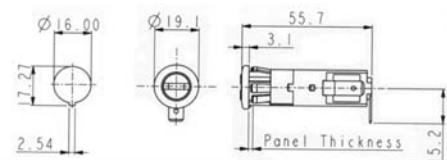

G-Sicherungshalter 6,3 x 32 mm

FX 0415 + FX 0416 / FX 0415S + FX 0416S / FX 0417



Fuse-holders



G-Sicherungshalter für Sicherungen / für 6,3 x 32 mm mit Schraubdeckel

Bemessungsstrom: 13 A
Bemessungsspannung: 250 V
Verlustleistung: 4 W (@ 23 °C)
Übergangswiderstand: < 5mΩ
Isolationswiderstand: > 10⁵ MΩ @ 500 V d.c
Durchschlagsfestigkeit: 4 kV @ 50 Hz

Fuse-holder for fuses for 6,3 x 32 mm with screw cap

Nominal current: 13 A
Voltage: 250 V
Sustained dissipation: 4 W (@ 23 °C)
Contact resistance: < 5mΩ
Insulation resistance: > 10⁵ MΩ @ 500 V d.c
A.C Breakdown: 4 kV @ 50 Hz

Bestell/ Order Nr.: FX 0415
FX 0416

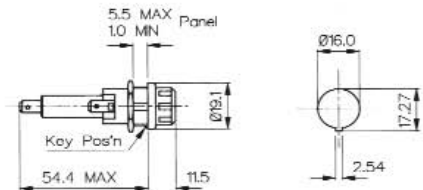

G-Sicherungshalter für Sicherungen / für 6,3 x 32 mm mit Schraubdeckel

Bemessungsstrom: 13 A
Bemessungsspannung: 250 V
Verlustleistung: 4 W (@ 23 °C)
Übergangswiderstand: < 5mΩ
Isolationswiderstand: > 10⁵ MΩ @ 500 V d.c
Durchschlagsfestigkeit: 4 kV @ 50 Hz

Fuse-holder for fuses for 6,3 x 32 mm with screw cap

Nominal current: 13 A
Voltage: 250 V
Sustained dissipation: 4 W (@ 23 °C)
Contact resistance: < 5mΩ
Insulation resistance: > 10⁵ MΩ @ 500 V d.c
A.C Breakdown: 4 kV @ 50 Hz

Bestell/ Order Nr.: FX 0415 S
FX 0416 S

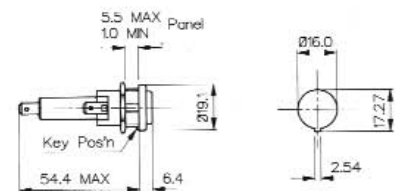

G-Sicherungshalter für Sicherungen / für 6,3 x 32 mm mit Schraubdeckel

Bemessungsstrom: 16 A
Bemessungsspannung: 250 V
Verlustleistung: 4 W (@ 23 °C)
Übergangswiderstand: < 10 mΩ
Isolationswiderstand: > 10⁶ MΩ @ 500 V d.c
Durchschlagsfestigkeit: > 2 kV

Fuse-holder for fuses for 6,3 x 32 mm with screw cap

Nominal current: 16 A
Voltage: 250 V
Sustained dissipation: 4 W (@ 23 °C)
Contact resistance: < 10 mΩ
Insulation resistance: > 10⁶ MΩ @ 500 V d.c
A.C Breakdown: > 2 kV

Bestell/ Order Nr.: FX 0417

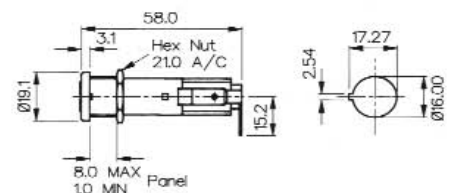

G-Sicherungshalter 10,3 x 38,1 mm

1038.215

Fuse-holders



G-Sicherungshalter für Sicherungen /
für 10,3 x 38,1 mm mit Schraubkappe
Bemessungsstrom: 30 A
Bemessungsspannung: 600 V
Übergangswiderstand: 5 mΩ
Isolationswiderstand: 100 MΩ
Durchschlagsfestigkeit: AC3000V/60"

Fuse-holder for fuses
for 10,3 x 38,1 mm with Screw cap
Nominal current: 30 A
Voltage: 600 V
Contact resistance: 5 mΩ
Insulation resistance: 100 MΩ
Dielectric strength: AC3000V/60"

Bestell/ Order Nr.: 1038.215

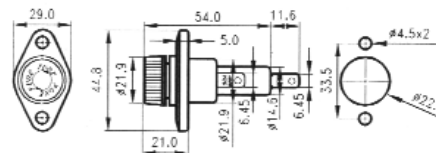

In-Line-Sicherungshalter 5 x 20 mm / 6,3 x 25 mm / 6,3 x 32 mm



G-Sicherungshalter für Sicherungen /
für 5 x 20 mm = FX 0380
für 6,3 x 25 mm = FX 0280
für 6,3 x 32 mm = FX 0180
Bemessungsstrom: 10 A
Bemessungsspannung: 250 V
Übergangswiderstand: < 10 mΩ
Isolationswiderstand: > 10⁵ MΩ @ 500 V d.c
Durchschlagsfestigkeit: 2 kV @ 50Hz

Fuse-holder for fuses
for 5 x 20 mm / 6,3 x 25mm / 6,3 x 32 mm
Nominal current: 10 A
Voltage: 250 V
Contact resistance: < 10 mΩ
Insulation resistance: > 10⁵ MΩ @ 500 V d.c
A.C Breakdown: 2 kV @ 50Hz

Bestell/ Order Nr.: FX 0180



FX 0280
FX 0380

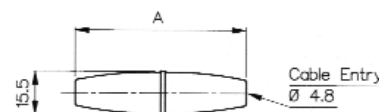

List No.	DIM A
FX0180	60.3
FX0280	54.5
FX0380	48.6



G-Sicherungshalter für Sicherungen /
für 5 x 20 mm = FX 0385
für 6,3 x 25 mm = FX 0285
für 6,3 x 32 mm = FX 0185
Bemessungsstrom: 10 A
Bemessungsspannung: 250 V
Übergangswiderstand: < 10 mΩ
Isolationswiderstand: > 10⁵ MΩ @ 500 V d.c
Durchschlagsfestigkeit: 2 kV @ 50Hz

Fuse-holder for fuses
for 5 x 20 mm / 6,3 x 25mm / 6,3 x 32 mm
Nominal current: 10 A
Voltage: 250 V
Contact resistance: < 10 mΩ
Insulation resistance: > 10⁵ MΩ @ 500 V d.c
A.C Breakdown: 2 kV @ 50Hz

Bestell/ Order Nr.: FX 0185



FX 0285
FX 0385

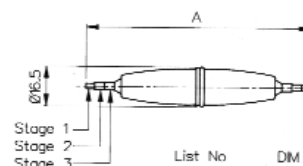

List No.	DIM A
FX0185	91.0
FX0285	85.2
FX0385	79.2



Sicherungshalter für UMF Sicherungen
Bemessungsstrom: 6,3 A
Bemessungsspannung: 250 V
Übergangswiderstand: auf Anfrage
Isolationswiderstand: auf Anfrage
Durchschlagsfestigkeit: auf Anfrage

Fuse-holder for UMF fuses
Nominal current: 6,3 A
Voltage: 250 V
Contact resistance: on request
Insulation resistance: on request
Dielectric strength: on request

Bestell/ Order Nr.: 920.000

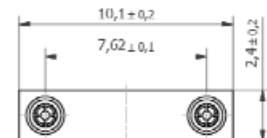
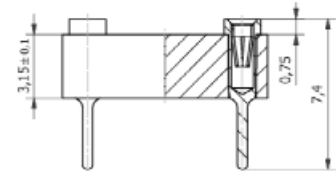

Socket für Kleinstsicherungen

886.000

Fuse-holder for sub-miniature fuses



Socket für Kleinstsicherungen
Stifte: Kupfer-Legierung, lötlbar, verzinkt
Bemessungsstrom: 6,3 A
Bemessungsspannung: 250 V
Verlustleistung: 1,6 W
Übergangswiderstand: < 4,3 mΩ

Fuse holder for sub-miniature fuses
Pins: Copper-alloy, solderable, tin plated
Nominal current: 6,3 A
Voltage: 250 V
Sustained dissipation: 1,6 W
Contact resistance: < 4,3 mΩ

Bestell/ Order Nr.: 886.000

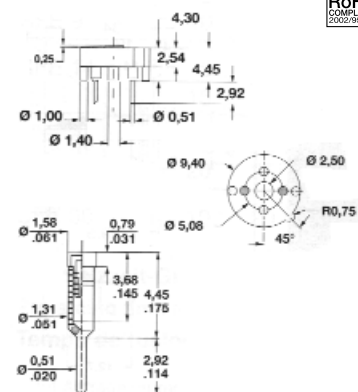

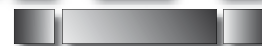

Technische Daten / Technical specifications	Offene Sicherungshalter / Open Fuse – holders			
Produktfoto / product picture				
Typ / type	5 x 20 503.000 / 503.100	5 x 20 503.200 / 503.600	5 x 20 503.300	5 x 20 503.400
Strom / current	6,3 A	6,3 A	6,3 A	6,3 A
Spannung / voltage	250 V	250 V	250 V	250 V
Übergangswiderstand / contact resistance	auf Anfrage / on request	auf Anfrage / on request	auf Anfrage / on request	< 5 mΩ
Isolationswiderstand / Insulation resistance	auf Anfrage / on request	auf Anfrage / on request	auf Anfrage / on request	> 100 MΩ
Durchschlagsfestigkeit / dielectric strength	auf Anfrage / on request	auf Anfrage / on request	auf Anfrage / on request	> 3000 Vac/60"
Verlustleistung / sustained dissipation (W)	auf Anfrage / on request	auf Anfrage / on request	1,6	1,6
Prüfzeichen / approvals			DIN IEC 60695-2-11 	
Katalogseite / catalogue page	119	119	119	120

Technische Daten / Technical specifications	Offene Sicherungshalter / Open Fuse – holders			
Produktfoto / product picture				
Typ / type	5 x 20 503.500	Abdeckkappe / Plastic - cover	5 x 20 503.370	5 x 20 503.550
Strom / current	6,3 A		6,3 A	6,3 A
Spannung / voltage	250 V		250 V	250 V
Übergangswiderstand / contact resistance	< 5 mΩ		auf Anfrage / on request	auf Anfrage / on request
Isolationswiderstand / Insulation resistance	> 100 MΩ		auf Anfrage / on request	auf Anfrage / on request
Durchschlagsfestigkeit / dielectric strength	> 3000 Vac/60"		auf Anfrage / on request	auf Anfrage / on request
Verlustleistung / sustained dissipation (W)	1,6		2,5 / 1,6	2,5 / 1,6
Prüfzeichen / approvals				
Katalogseite / catalogue page	120	120	121	121

Technische Daten / Technical specifications	Offene Sicherungshalter / Open Fuse – holders				
Produktfoto / product picture					
Typ / type	5 x 20 Einführhilfe / fuse puller	5 x 20 506.000	5 x 20 501.100	6,3 x 32 503.700 / 503.800	6,3 x 32 503.900 / 504.000
Strom / current		6,3 A	6,3 A	6,3 A	6,3 A
Spannung / voltage		250 V	250 V	250 V	250 V
Übergangswiderstand / contact resistance		< 5 mΩ	auf Anfrage / on request	auf Anfrage / on request	auf Anfrage / on request
Isolationswiderstand / Insulation resistance		> 100 MΩ	auf Anfrage / on request	auf Anfrage / on request	auf Anfrage / on request
Durchschlagsfestigkeit / dielectric strength		> 3000 Vac/60"	auf Anfrage / on request	auf Anfrage / on request	auf Anfrage / on request
Verlustleistung / sustained dissipation(W)		1,6	1,6	auf Anfrage / on request	auf Anfrage / on request
Prüfzeichen / approvals					
Katalogseite / catalogue page	121	122	122	123	123

Technische Daten / Technical specifications	Sicherungshalter / Fuse – holders			
Produktfoto / product picture				
Typ / type	5 x 20 121.000	6,3 x 32 120.100	Hochspannung / high tension Geschlossen / closed	Hochspannung / high tension offen / open
Strom / current	6,3 A	6,3 A	6,3 A / 2 A	6,3 A / 2 A
Spannung / voltage	250 V	250 V	0,5 kV – 3,0 kV	0,5 kV – 10 kV
Prüfzeichen / approvals				
Katalogseite / catalogue page	124	124	125	125

Offene Sicherungshalter

5 x 20 mm

503.000 / 503.100

Open Fuse-holders



5030

5031

Offene Sicherungshalter für gedruckte Schaltungen 5 x 20 mm

Rastermaß: 22,5 mm
Bemessungsstrom: 6,3 A
Bemessungsspannung: 250 V
Schraubbefestigung: M 3 x 4,5 mm

Open fuse-holders for printed circuits 5 x 20 mm

Module: 22,5 mm
Nominal current: 6,3 A
Voltage: 250 V
Fastening with screws: M 3 x 4,5 mm

Bestell/ Order Nr.:

503.000 / 503.100
5030 / 5031



Offene Sicherungshalter

5 x 20 mm

503.200 / 503.600

Open Fuse-holders

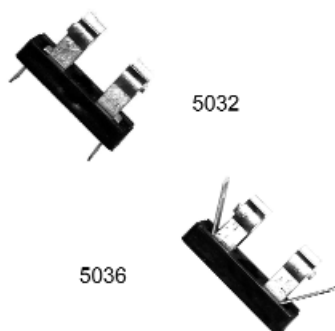

5032

5036

Offene Sicherungshalter für gedruckte Schaltungen 5 x 20 mm

Rastermaß: 22,5 mm
Bemessungsstrom: 6,3 A
Bemessungsspannung: 250 V
Schraubbefestigung: M 3 x 4,5 mm

Open fuse-holders for printed circuits 5 x 20 mm

Module: 22,5 mm
Nominal current: 6,3 A
Voltage: 250 V
Fastening with screws: M 3 x 4,5 mm

Bestell/ Order Nr.:

503.200 / 503.600
5032 / 5036



Offener Sicherungshalter

5 x 20 mm

503.300

Open Fuse-holder



Offener Sicherungshalter für gedruckte Schaltungen 5 x 20 mm

Bemessungsstrom: 6,3 A
Bemessungsspannung: 250 V
Verlustleistung: 1,6 W

Open fuse-holder for printed circuits 5 x 20 mm

Nominal current: 6,3 A
Voltage: 250 V
Sustained dissipation: 1,6 W

Bestell/ Order Nr.: 503.300

5033 VDE

DIN IEC 60695-2-11

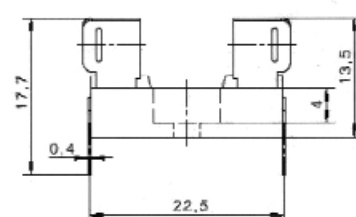

Offener Sicherungshalter 5 x 20 mm

503.400

Open Fuse-holder



Offener Sicherungshalter für gedruckte Schaltungen 5 x 20 mm
Bemessungsstrom: 6,3 A
Bemessungsspannung: 250 V
Verlustleistung: 1,6 W
Übergangswiderstand: < 5mΩ
Isolationswiderstand: > 100 MΩ
Durchschlagsfestigkeit: > 3000 Vac/60"

Open fuse-holder for printed circuits 5 x 20 mm
Nominal current: 6,3 A
Voltage: 250 V
Sustained dissipation: 1,6 W
Contact resistance: < 5mΩ
Insulation resistance: 100 MΩ
Dielectric strength: > 3000 Vac/60"

Bestell/ Order Nr.:503.400
5034

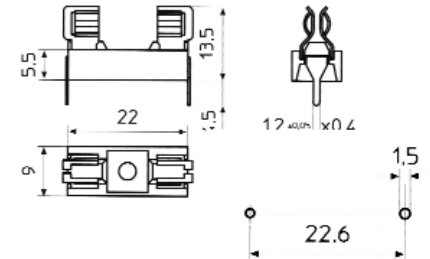

Offener Sicherungshalter 5 x 20 mm

503.500

Open Fuse-holder



Offener Sicherungshalter für gedruckte Schaltungen 5 x 20 mm
Bemessungsstrom: 6,3 A
Bemessungsspannung: 250 V
Verlustleistung: 1,6 W
Übergangswiderstand: < 5mΩ
Isolationswiderstand: > 100 MΩ
Durchschlagsfestigkeit: > 3000 Vac/60"

Open fuse-holder for printed circuits 5 x 20 mm
Nominal current: 6,3 A
Voltage: 250 V
Sustained dissipation: 1,6 W
Contact resistance: < 5mΩ
Insulation resistance: 100 MΩ
Dielectric strength: > 3000 Vac/60"

Bestell/ Order Nr.:503.500
5035

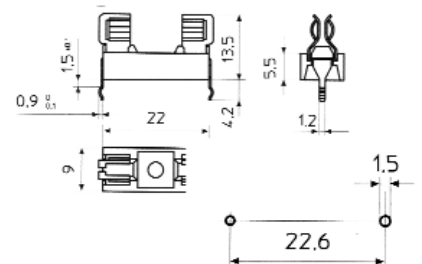

Abdeckkappe

503.310

Plastic-cover



Abdeckkappe für Sicherungshalter durchsichtig

Plastic – cover for fuse-holder transparent

Bestell/ Order Nr.:503.310

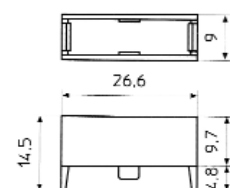

Offener Sicherungshalter 5 x 20 mm

503.370

Open Fuse-holder



Offener Sicherungshalter für gedruckte Schaltungen 5 x 20 mm

Bemessungsstrom: 6,3 A
Bemessungsspannung: 250 V
Verlustleistung: 2,5 W / 1,6 W

Open fuse-holder for printed circuits 5 x 20mm
Nominal current: 6,3 A
Voltage: 250 V
Sustained dissipation: 2,5 W / 1,6 W

Bestell/ Order Nr.:503.370

DIN 60695-2-13



Offener Sicherungshalter 5 x 20 mm

503.550

Open Fuse-holder



Offener Sicherungshalter für gedruckte Schaltungen 5 x 20 mm

Bemessungsstrom: 6,3 A
Bemessungsspannung: 250 V
Verlustleistung: 2,5 W / 1,6 W

Open fuse-holder for printed circuits 5 x 20mm
Nominal current: 6,3 A
Voltage: 250 V
Sustained dissipation:: 2,5 W / 1,6 W

Bestell/ Order Nr.:503.550

DIN 60695-2-13



Einführhilfe

503.360

Fuse puller



Einführhilfe für 5 x 20 mm Sicherungen

Material: Noryl
Farben: schwarz / braun / rot / weiß / blau / grün, weitere Farben auf Anfrage

Lieferungszustand: lose oder mit Sicherungshalter 503.370 / 503.550 magaziniert / lose

Fuse puller for 5 x 20 mm fuses
Material: Noryl
Colour: black / brown / red / white / blue green, further colours on request
Delivery condition: loose or with fuse-holder 503.370 / 503.550 magazined / loose

Bestell/ Order Nr.:503.360



1)

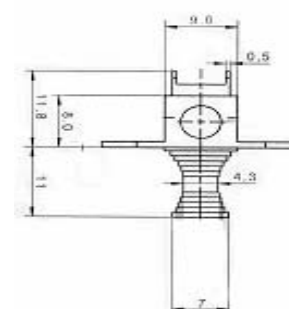

1) In Verbindung mit Sicherungshalter 503.370 (max. 6,3 A/ Bemessungsstrom 2,5W/1,6W)
To be in contact with fuse-holder 503.370 (max 6,3 A /rated power 2,5W/1,6W)

Offener Sicherungshalter 5 x 20 mm

506.000

Open Fuse-holder



G-Sicherungshalter für Sicherungen /
5 x 20 mm, mit Kappe
Bemessungsstrom: 6,3 A
Bemessungsspannung: 250 V
Verlustleistung: 1,6 W
Übergangswiderstand: < 5m
Isolationswiderstand: >100 M
Durchschlagsfestigkeit: > 3000 Vac/60s
Kontakte: CuZn37 + Ni + Sn

Fuse-holder for fuses
5 x 20 mm, with cap
Nominal current: 6,3 A
Voltage: 250 V
Sustained dissipation: 1,6 W
Contact resistance: < 5m
Insulation resistance: >100 M
Dielectric strength: > 3000 Vac/60"
Contact: CuZn37 + Ni + Sn

Bestell/ Order Nr.: 506.000
5060 I

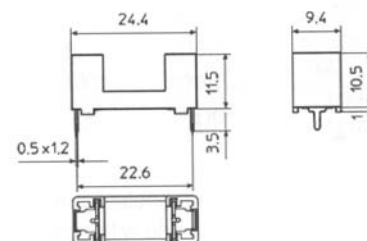

Offener Sicherungshalter 5 x 20 mm

501.100

Open Fuse-holder



G-Sicherungshalter für Sicherungen /
5 x 20 mm
Bemessungsstrom: 6,3 A
Bemessungsspannung: 250 V
Verlustleistung: 1,6 W
Halter: weißes Thermoplast, UL 94V0
Kontakte: CuSn 7 + Sn

Fuse-holder for fuses
5 x 20 mm
Nominal current: 6,3 A
Voltage: 250 V
Sustained dissipation: 1,6 W
Holder: white Thermoplast, UL 94V0
Contacts: CuSn 7 + Sn

Bestell/ Order Nr.: 501.100

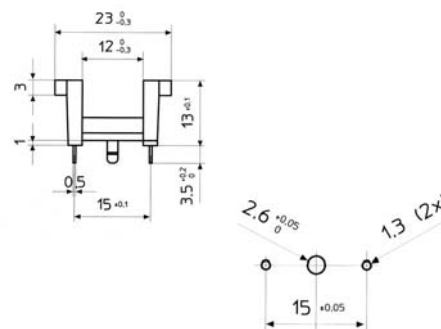

Offene Sicherungshalter 6,3 x 32 mm

503.700 / 503.800

Open Fuse-holders



5037



5038

Offene Sicherungshalter für gedruckte Schaltungen für 6,3 x 32 mm
Bemessungsstrom: 6,3 A
Bemessungsspannung: 250 V
Schraubbefestigung: M 3 x 4,5 mm

Open fuse-holders for printed circuits for 6,3 x 32 mm
Nominal current: 6,3 A
Voltage: 250 V
Fastening with screws: M 3 x 4,5 mm

Bestell/ Order Nr.:

503.700 / 503.800

5037 / 5038



Offene Sicherungshalter 6,3 x 32 mm

503.900 / 504.000

Open Fuse-holders



5039



5040

Offene Sicherungshalter für gedruckte Schaltungen für 6,3 x 32 mm
Bemessungsstrom: 6,3 A
Bemessungsspannung: 250 V
Schraubbefestigung: M 3 x 4,5 mm

Open fuse-holders for printed circuits for 6,3 x 32 mm
Nominal current: 6,3 A
Voltage: 250 V
Fastening with screws: M 3 x 4,5 mm

Bestell/ Order Nr.:

503.900 / 504.000

5039 / 5040





Hochspannungs-G-Sicherungshalter -geschlossene Bauart mit Schraubkappe-

Bemessungsstrom/ 0,5kV / 6,3 A
Bemessungsspannung: 1,2kV / 6,3 A
3,0 kV / 2,0 A

Prüfspannung(50Hz,1min): 10kV
Länge (Maß L): 54 - 99 mm
Gewicht 39 - 45 g
Sicherungsdurchmesser: 8 mm
Schutzgrad: IP 40

High tension fuse holder -closed type with screw cap-

Voltage / current: 0,5 kV / 6,3 A
1,2 kV / 6,3 A
3,0 kV / 2,0 A

Test voltage (50Hz,1min): 10 kV
Length (dimension L): 54 - 99 mm
Weight: 39 - 45 g
Fuse diameter: 8 mm
Level of protection: IP 40

Bestell/ Order Nr.:

556.200
557.200
558.200



Hochspannungs-G-Sicherungshalter -offene Bauart -

Bemessungsstrom/ 0,5 kV / 6,3 A
Bemessungsspannung: 1,2 kV / 6,3 A
3,0 kV / 4,0 A
6,0 kV / 6,3 A
10 kV / 6,3 A

Länge (Maß L): 42 - 152 mm
Gewicht: 7,4 - 14,4 g
Sicherungsdurchmesser: 8 mm
Schutzgrad: IP 00

High tension fuse holder -base mount-







Voltage / current: 0,5 kV / 6,3 A
1,2 kV / 6,3 A
3,0 kV / 4,0 A
6,0 kV / 6,3 A
10 kV / 6,3 A







Length (dimension L): 42 - 152 mm
Weight: 7,4 - 14,4 g
Fuse diameter: 8 mm
Level of protection: IP 00

Bestell/ Order Nr.:

556.100
557.100
558.100
559.100
560.100

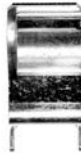

Technische Daten / Technical specifications	Haltefedern für Sicherungen / Fuse Clips		
Produktfoto / product picture			
Typ / type	5 x 20 120.700 / 120.800	5 x 20 121.700	5 x 20 122.000
Strom / current	6,3 A	8 A / 5 A	6,3 A
Spannung / voltage	500 V	250 V	500 V max
RoHS			
Katalogseite / catalogue page	127	127	127

Technische Daten / Technical specifications	Haltefedern für Sicherungen / Fuse Clips		
Produktfoto / product picture			
Typ / type	5 x 20 / 6,3 x 32 120.500	6,3 x 32 121.500	10,3 x 38 120.600
Strom / current	10 A	10 A	20 A max.
Spannung / voltage	250 V	250 V	600 V
RoHS			
Katalogseite / catalogue page	128	128	128

Haltefedern

5 x 20 mm

No. 120.700 / 120.800

Clips for fuses

ESKA

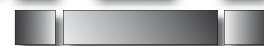

1207



1208

Haltefedern für Sicherungen für 5 x 20 mm

Bemessungsstrom: 6,3 A
Bemessungsspannung: 500 V max.
Material: Kupferlegierung lötlbar, verzinkt

Clips for fuses for 5 x 20 mm

Nominal current: 6,3 A
Voltage: 500 V max
Material: copper alloy solderable, tin-plated

	1207	1208
b 2 x l 2	4 x 9,5	4 x 8
b 1 x l 1	1,2 x 2,5	1,2 x 3,5
l 3	8	7,5
a	5	5
Material, s	Ms 0,4	Ms 0,4 Bz 0,4
gr ‰ ≈	350	370 390

Bestell/ Order Nr.:

120.700 / 120.800

1207 / 1208

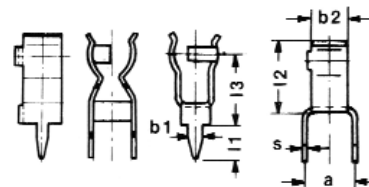

Haltefedern

5 x 20 mm

No. 121.700

Clips for fuses



Haltefedern für Sicherungen 5 x 20 mm

Bemessungsstrom: 8 A / 5 A
Bemessungsspannung: 250 V
Material: Kupferlegierung lötlbar, verzinkt

Clips for fuses 5 x 20 mm

Nominal current: 8 A / 5 A
Voltage: 250 V
Material: copper alloy solderable, tin-plated

Bestell/ Order Nr.: 121.700

1217

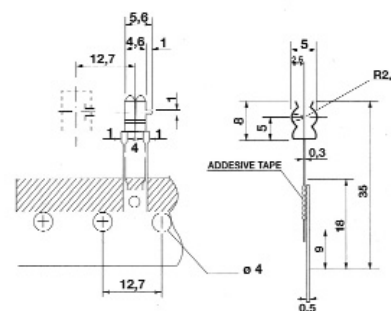

Haltefedern

5 x 20 mm

No. 122.000

Clips for fuses



Haltefedern für Sicherungen 5 x 20 mm

Bemessungsstrom: 6,3 A
Bemessungsspannung: 500 V max.

Material: Vernickelt $4 \pm 2 \mu\text{m}$ und galv. glanzverzinkt $8 \pm 3 \mu\text{m}$
Verpackungsmöglichkeiten:
Blistergurtverpackung aus Polyester, farblos.
12 mm breit, 0,3 mm dick, mit dissipativem Abdeckband, auf Pappspulen $\varnothing 560$ mm aufgewickelt.

Clips for fuses 5 x 20 mm

Nominal current: 6,3 A
Voltage: 500 V max
Material: nickel-plated $4 \pm 2 \mu\text{m}$ and tin-plated $8 \pm 3 \mu\text{m}$
Packing opinions:
Transparent belted blister pack, material: polyester.
Width: 12 mm, thickness: 0,3 mm, with dissipative cover band, reeled on paperboard-reel $\varnothing 560$ mm.

Bestell/ Order Nr.:122.000

1220

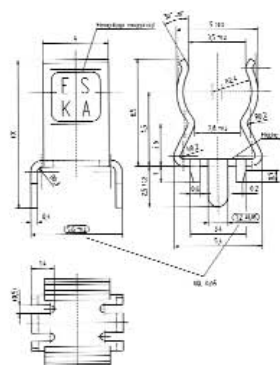

Haltefedern

No. 120.500

Clips for fuses

5 x 20 mm / 6,3 x 32 mm

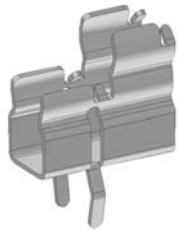

Haltefedern für Sicherungen
5 x 20 mm / 6,3 x 32 mm
Bemessungsstrom: 10 A
Bemessungsspannung: 250 V
Material: CuZn37, lötlbar, verzinkt

Clips for fuses
5 x 20 mm / 6,3 x 32 mm
Nominal current: 10 A
Voltage: 250 V
Material: CuZn37 bright tin plated

Bestell/ Order Nr.: 120.500

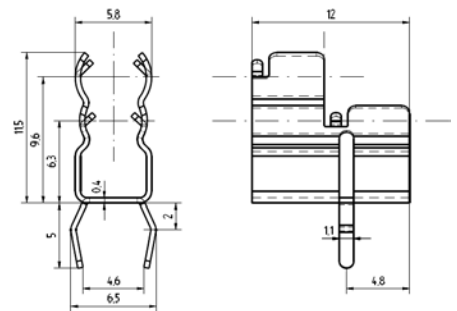

Haltefedern

No. 121.500

Clips for fuses

6,3 x 32 mm



Haltefedern für Sicherungen
6,3 x 32 mm
Bemessungsstrom: 10 A
Bemessungsspannung: 250 V
Material: Kupferlegierung lötlbar, verzinkt

Clips for fuses 6,3 x 32 mm
Nominal current: 10 A
Voltage: 250 V
Material: copper alloy solderable, tin-plated

Bestell/ Order Nr.: 121.500
1215

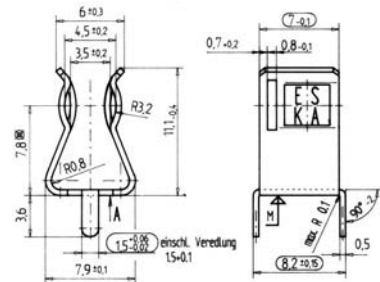

	1215
b 2 x l 2	7 x 11
b 1 x l 1	1,5 x 3,5
l 3	7,2
d + 0,1	-
Material, s	Ms 0,5
gr ‰	830

Haltefedern

No. 120.600

Clips for fuses

10,3 x 38 mm

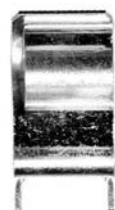

Haltefedern für Sicherungen
10,3 x 38 mm
Bemessungsstrom: 20 A max
Bemessungsspannung: 600 V
Material: Bronze, glänzend verzinkt

Clips for fuses 10,3 x 38 mm
Nominal current: 20 A max
Voltage: 600 V
Material: bronze, bright tin

Bestell/ Order Nr.: 120.600

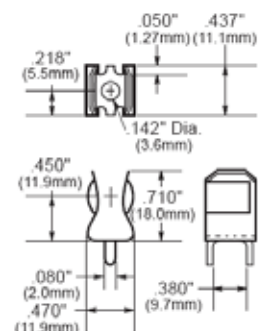



Diverse Varianten von Baugruppen mit 5 x 20 mm Sicherungen.

Diverse variations of assemblies with 5 x 20 mm fuses.

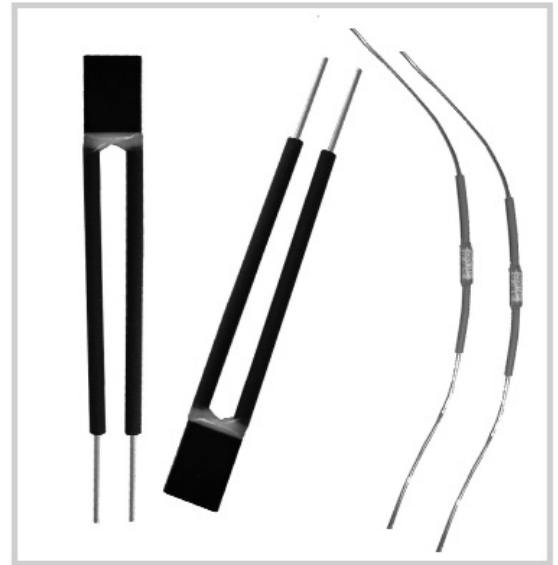

Kundenspezifische Ausführungen von Temperatursicherungen.

Customized versions of thermal cutoffs.



Mögliche Optionen für Bimetall-Temperatur – schalter, Temperatursensoren, etc.

Possible options for bimetal thermostats, sensors, etc.

Magazinierte Verpackungsformen für Feinsicherungen, auch mit Sicherungshaltern.

Magazined packing units for fuses, also with fuseholders.

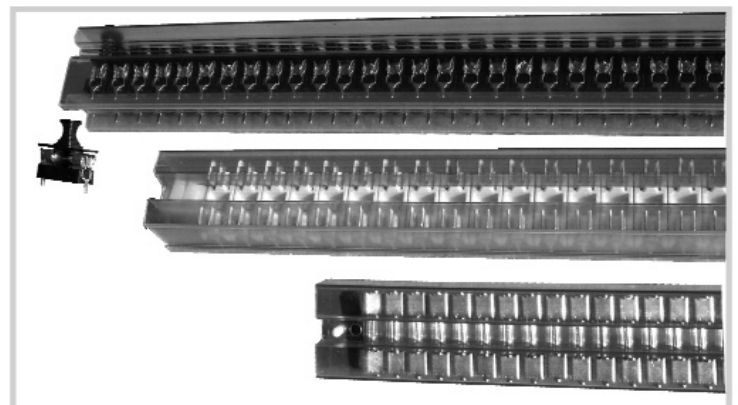

Peter Baack
Rosenstraße 26
59379 Selm

Tel.: 0 23 06 / 75 52 02
Fax: 0 23 06 / 75 52 03

peter.baack@bossmail.de

Handy 01 72 / 9 40 50 33

Walter Daniel
Saarwerdenstr. 17a
41541 Dormagen

Tel.: 0 21 33 / 50 23 32
Fax: 0 21 33 / 50 23 34

walter.daniel@t-online.de

Hipp Industrievertretung GmbH
Zum Engelberg 4
79249 Merzhausen

Tel.: 07 61 / 40 24 25
Fax: 07 61 / 40 83 51

info@hipp-gmbh-fr.de

Frank Husmann
Handelsvertretungen
Hermann-Löns-Weg 5
27711 Osterholz-Scharmbeck

Tel.: 0 47 95 / 4 98
Fax: 0 47 95 / 73 51

info@fhusmann.de
www.fhusmann.de





Ing.-Büro Theodor Metz
Werksvertretungen
Badenstr. 1
40883 Ratingen

Tel.: 0 21 02 / 6 75 21
Fax: 0 21 02 / 6 83 26

th.metz@t-online.de

Ing.-Büro M. K. Schneider
Am Sportfeld 7a
64665 Alsbach-Hähnlein

Tel.: 0 62 57 / 93 45 20
Fax: 0 62 57 / 90 45 45

info@schneider-elektrovertrieb.de
www.schneider-elektrovertrieb.de

Streb GmbH
Industriervertretungen
Albrecht-Dürer-Str. 24
90522 Oberasbach

Tel.: 09 11 / 69 90 63
Fax: 09 11 / 69 77 76

info@streb-gmbh.de
www.streb-gmbh.de

Wilhelm Weissinger
Industriervertretungen
Inh. Peter Wanner
Bruckstr. 42
70734 Fellbach

Tel.: 07 11 / 57 76 69 80
Fax: 07 11 / 57 76 69 66

info@weissinger.de
www.weissinger.de

Partner International



Australien	SWE-CHECK PTY LTD. AUS - 3191 Sandringham	T: 0061 / 3 / 95216133 F: 0061 / 3 / 95216177	sales@swecheck.com.au www.swecheck.com.au
Belgien	Conrad Electronic Benelux BV Michel Decamp S.A./N.V. 1400 Nivelles	T: 0032 / 2 / 3850035 F: 0032 / 2 / 3850368	
	L. Vandenberghe n.v./s.a. B - 2970 Schilde	T: 0032 / 3 / 3538795 F: 0032 / 3 / 3533795	vandenberghe_luc@skynet.be www.vandenberghe.com
Bulgarien	K1 Electronics Ltd. BG - 1606 Sofia	T: 00359 / 2 / 9531550 F: 00359 / 2 / 9524908	office@k1-bg.com www.k1-bg.com
Dänemark	Dansk Belysnings Service A/S DK - 2600 Glostrup	T: 0045 / 43 / 453544 F: 0045 / 43 / 432332	dbbs@dbbslys.dk www.dbbslys.dk
England	Conrad Electronic SE		
Finnland	TELE-TUKKU OY FIN - 04430 Järvenpää	T: 00358 / 9 / 41332200 F: 00358 / 9 / 41332244	eira@tele-tukku.fi www.tele-tukku.fi
Frankreich	Conrad Electronic S.A.S. ENDRICH Bauelemente F - 75012 Paris	T: 0033 / 1 / 55782250 F: 0033 / 1 / 55782251	p.gaydan@endrich.com
	ENDRICH Bauelemente F - 71210 Montchanin	T: 0033 / 3 / 85785076 F: 0033 / 3 / 85788002	c.magny@endrich.com
Israel	Dawntek Electronics Ltd. IL - 43106 Ra'anana	T: 00972 / 9 / 7444562 F: 00972 / 9 / 7444568	dov@dawntek.co.il
Italien	ENDRICH Elettronica S.r.l. I - 20027 Rescaldina (Milano)	T: 0039 / 0331 / 576925 F: 0039 / 0331 / 466021	endrichel@iol.it
	ENDRICH Elettronica S.r.l. I - 20090 Segrate (Milano)	T: 0039 / 02 / 26923295 F: 0039 / 02 / 26953870	acsell.js@tiscalinet.it
Korea	Myung Shin Industronic Co., Ltd. KR - Seoul	T: 0082 / 2 2275 2535 F: 0082 / 2 2278 4401	sales@msfuse.co.kr www.msfuse.co.kr
Niederlande	Conrad Electronic Benelux BV Koula & Dijkers B.V. NL - 1190 AA Ouderkerk a/d Amstel	T: 0031 / 204965056 F: 0031 / 204965906	l.hesterman@kodik.nl www.kodik.nl
Norwegen	Staubo Elektro-Maskin AS N - 0666 Oslo	T: 0047 / 23 / 258900 F: 0047 / 23 / 258901	ellen.hansen@staubo.no www.staubo.no
Österreich	Conrad Electronic SE & Co. KG ENDRICH Bauelemente A - 2344 Maria Enzersdorf am Gebirge	T: 0043 / 223623621 F: 0043 / 223623619	w.eichberger@endrich.com
Polen	Strecker- Electronic PL - 50457 Wroclaw Transfer Multisort Elektronik PL - 93350 Lodz	T: 0048 / 71 3422907 F: 0048 / 71 3418464 T: 0048 / 42 / 6400106 F: 0048 / 42 / 6400107	tme@tme.pl www.tme.pl
Portugal	Lopedifer LDA. P - 2795-144 Linda a Velha	T: 00351 / 214146920 F: 00351 / 214146929	comptronica@mail.telepac.pt

Partners international



Schweden

AAAAA Nordic AB
S - 23539 Vellinge

T: 0046 / 40 / 426630
F: 0046 / 40 / 426633

sales@aaaaa.se
www.aaaaa.se

Conrad Elektronik Norden AB

InterOptron AB
S - 17506 Järfälla

T: 0046 / 8 / 7958500
F: 0046 / 8 / 7957777

info@interoptron.se
www.interoptron.se

Schweiz

Conrad Electronic AG

VIBRATEC AG
CH - 5507 Mellingen

T: 0041 / 56 / 4910181
F: 0041 / 56 / 4910188

info@vibratec.ch
www.vibratec.ch

Slowakei

Conrad Electronic S.R.O.

Slowenien

Conrad Electronic D.O.O. K.D.

IC elektronika d.o.o.
SI - 1000 Ljubljana

T: 00386 / 1 / 5680133
F: 00386 / 1 / 5689107

info@ic-elect.si
www.ic-elect.si

Spanien

Aldinet S.L.
E - 20240 Ordizia

T: 0034 / 943 / 805420
F: 0034 / 943 / 163033

aldinet@aldinet.com
www.aldinet.com

ENDRICH Bauelemente S.L.
E - 28440 Guadarama

T: 0034 / 918 / 491058

spain@endrich.com

ENDRICH Bauelemente S.L.
E - 08006 Barcelona

T: 0034 / 932 / 173144
F: 0034 / 932 / 179720

spain@endrich.com

Südafrika

AVNET KOPP (PTY) Ltd.
ZA - Rivonia 2128

T: 0027 / 11 / 4442333
F: 0027 / 11 / 4441706

sales@avnet.co.za
www.avnetkopp.co.za

FUSECOMP cc
ZA - Rivonia 2128

T: 0027 / 11 / 8027072
F: 0027 / 11 / 8043098

gunth@worldonline.co.za
www.fusecomp.com

Tschechien

EST Elektro-System-Technik S.R.O
CZ - 19000 Praha 9 Vysocany

T: 00420 / 2 / 66090711
F: 00420 / 2 / 66090717

est@est-praha.cz
www.est-praha.cz

Mechatronic spol. s.r.o.
CZ - 14800 Praha 4

T: 00420 / 2 / 67913973
F: 00420 / 2 / 67913973

mechatronic@volny.cz

Türkei

SE-YA Elektro
TR - 35280 Kücükalyi- IZMIR

T: 0090 / 232 2437970
F: 0090 / 232 2434297

Süreyya Elektrik
TR - 80020 Karaköy- Istanbul

T: 0090 / 212 2456448
F: 0090 / 212 2456448

Ukraine

FTF Impuls
UA - 93400 Lugansk region

T: 00380 / 645227715
F: 00380 / 645227715

vtfimp@is.ua

Ungarn

Compex Kft
H - 1115 Budapest

T: 0036 / 1 2065771
F: 0036 / 1 2065725

compex@vnet.hu

Endrich GmbH
H - 1138 Budapest

T: 0036 / 1 / 2974191
F: 0036 / 1 / 2974192

endrich@endrich.com
www.endrich.com

Robtron Elektronik Trade Kft.
H - 6726 Szeged

T: 0036 / 62 / 549605
F: 0036 / 62 / 549610

purchasing@ret.hu
www.ret.hu

USA

Dynamic Marine Electric
USA - 33023 Hollywood, Fla.

T: 001 / 954 / 9642880
F: 001 / 954 / 9647077

dynamicm@ix.netcom.com

Katalog-Distributoren:

■	ASWO	Eime
■	Bürklin	München und Düsseldorf
■	Conrad	Hirschau
■	Reichelt	Sande
■	Schukat	Monheim

Distributoren Industrie:

■	AL-Elektronik	Braunschweig
■	Dibtronic	Nürnberg
■	Endrich	Nagold
■	PR-Tronik	Karlsbad / Ittersbach
■	Repro	Neu-Anspach

Distributoren Großhandel:

■	Scharnberger + Hasenbein	Nordstemmen
---	---------------------------------	-------------

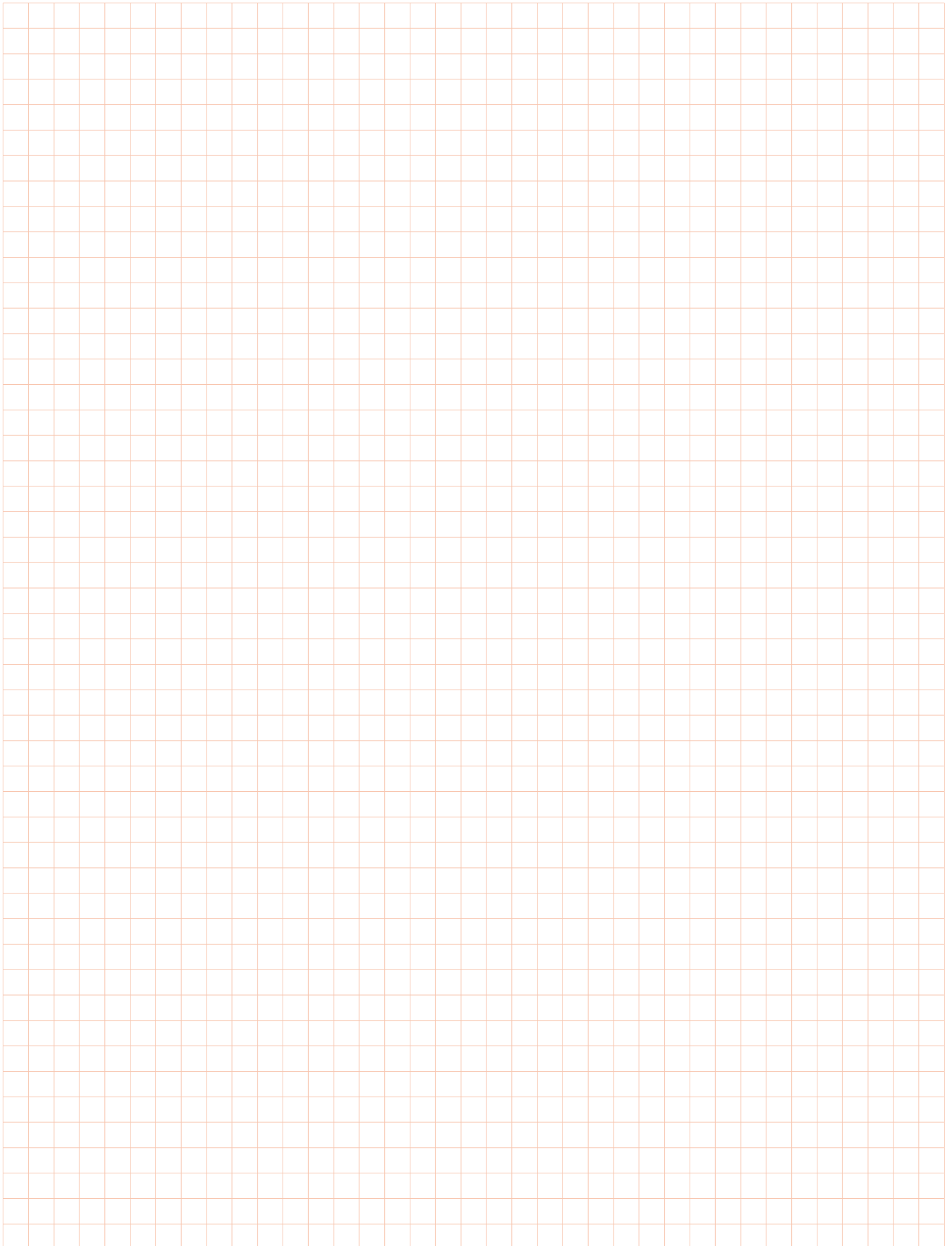

AUTOMOTIVE

ESKA

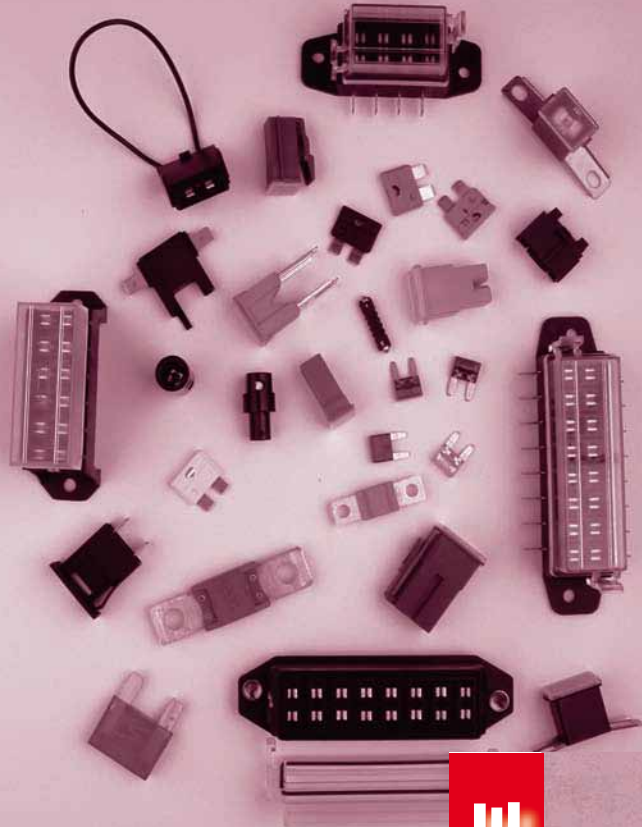

Weitere Informationen können Sie unserem Sonderkatalog „Automotive“ entnehmen.

TEMPERATURE

ESKA

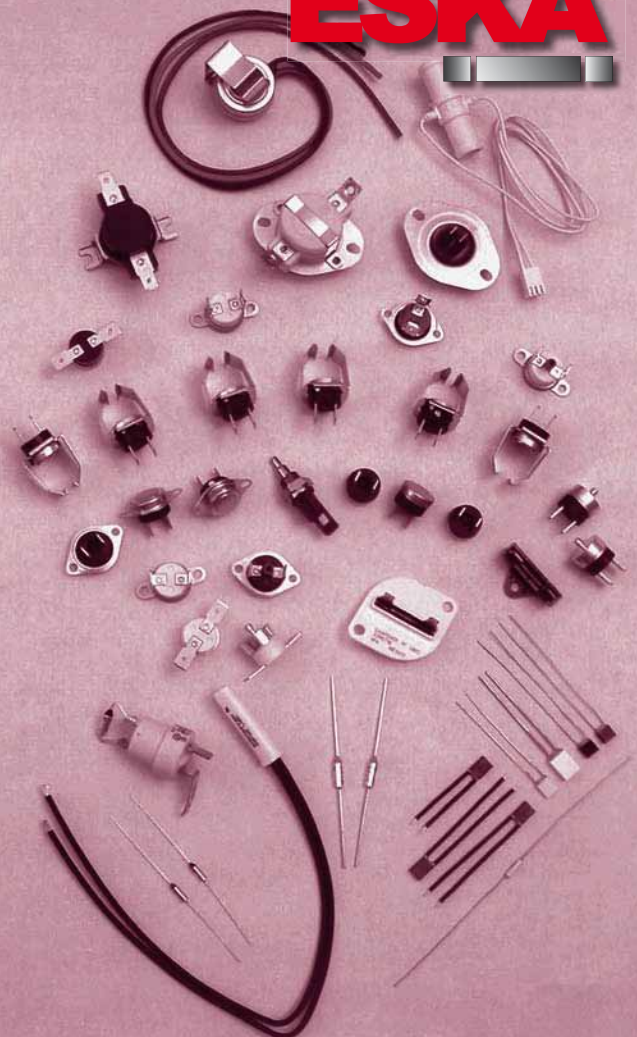

Weitere Informationen können Sie unserem Sonderkatalog „Temperature“ entnehmen.

EU-Richtlinien 2002/95/EG / Verbot des Einsatzes von Gefahrstoffen

Die Richtlinie über Stoffverbote (Richtlinie zur Beschränkung der Verwendung bestimmter gefährlicher Stoffe in Elektro- und Elektronikgeräten, RoHS) regelt die Beschränkung des Inverkehrbringens von Blei, Cadmium, Quecksilber, sechswertigem Chrom, polybromierten Biphenylen (PBB) und polybromiertem Diphenylether (PBDE), beginnend am 01. Juli 2006.

In diesem Geltungsbereich fallen z. B. folgende Geräte und die in diesen Geräten eingebauten Komponenten:

- Haushaltsgeräte
- Haushaltskleingeräte
- IT- und Telekommunikationsgeräte
- Unterhaltungselektronikgeräte
- Beleuchtungskörper, Glühlampen und Leuchten
- Elektrische und elektronische, mobile Werkzeuge
- Spielzeug, Sport- und Freizeitgeräte
- Automatische Ausgabegeräte
- Fest mit den vorstehend genannten Geräten verbundene Stecker und Anschlussleitungen

Selbstverständlich sind auch noch die bekannten, „verbleiten“ Typen lieferbar; in diesem Fall setzen Sie bei Ihren Bestellungen bitte ein „L“ vor die gewünschte Artikelnummer, z. B. ESKA L522.517 (5x20mm, träge, 250V, 1A, verbleit); generell wird seit Juli 2005 RoHS-Kompatible Ware geliefert.

ESKA Erich Schweizer GmbH
Elektrotechnische Fabrik

Stand: Oktober 2006 - Änderungen vorbehalten.

EU-Directive 2002/95/EG / Restriction of hazardous substances

These new European Directive introduces new environmental responsibilities for electrical and electronics equipment manufacturers. The RoHS (Restriction of use of certain hazardous substances) directive, part of the WEEE (Waste electrical and electronic equipment) directive, is due to come into force on 1st July 2006 and effectively bans the use of certain chemicals, defined as lead, cadmium, mercury, hexavalent chromium, polybrominated biphenyl (PBB) - flame retardant, polybrominated diphenyl ether (PBDE) - flame retardant. The following units and components integrated in these units belong to this ambit:

- Big domestic appliances
- Small domestic appliances
- IT and Tele-Communication units
- Entertainment electronics
- Lighting fixture, incandescent lamps
- Electrical and electronic tools
- Toys, sport- and leisure time units
- Automatical output devices
- Connectors and power supply cords which are firmly linked with a. m. units

Well known „lead“ types are still available certainly; in this case please set an „L“ in front of wanted article number on your orders, for example ESKA L522.517 (5x20 mm, time-lag, 250V, 1A, leaded); since Juli 2005 RoHS-compliant goods are delivered in general.

ESKA Erich Schweizer GmbH
Elektrotechnische Fabrik

State of affairs: October 2006 – Subject to change without notice



ESKA

A graphic element consisting of three horizontal bars of varying lengths, stacked vertically, positioned below the 'ESKA' text.

ERICH SCHWEIZER GMBH
Elektrotechnische Fabrik

Antonius - Raab - Str. 10
D-34123 Kassel

Telefon (0561) 5 89 04-0
Telefax (0561) 5 89 04-22

Postfach 200134
D-34080 Kassel

Internet: <http://www.eska-fuses.de>
e-mail: mail@eska-fuses.de