

Datasheet

RS PRO Aluminium die-cast EX Enclosure, silver grey, IP66, ATEX

Stock No: 2131641



Technical Specifications:

Material	DIN EN 1706 EN AC-Alsi 12 (Fe)
Colour	Powder coating, RAL 7001, silver grey
Dimension	120 x 220 x 91 mm (HxWxL)
NEMA	1, 3S, 4x, 12
IP Rating	IP66
Impact resistance	IK 09 in reference to EN 60068-2-75
Seal	Polyurethane seal
Temperature range	-50° up to +125°C
Approvals	ATEX, IEC Ex, EAC-approved UL 508 A, Maritime Register of shipping, Lloyds register

Features & Benefits:

- incl. in delivery: base, lid, seal, captive +/- stainless steel screws, 4 cooper plated earthing screws
- Ex-U certified enclosure for chemical and hazardous atmospheres
- EMC base shielded enclosure (even in standard execution more than 90-99% attenuation)
- high level of corrosion protection by use of alloy with low copper content
- watertight solution for outdoor and indoor application

Dimensional line drawings

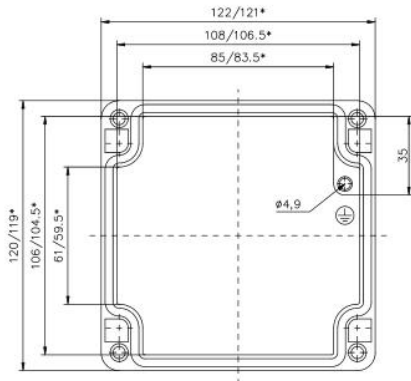

Deckel

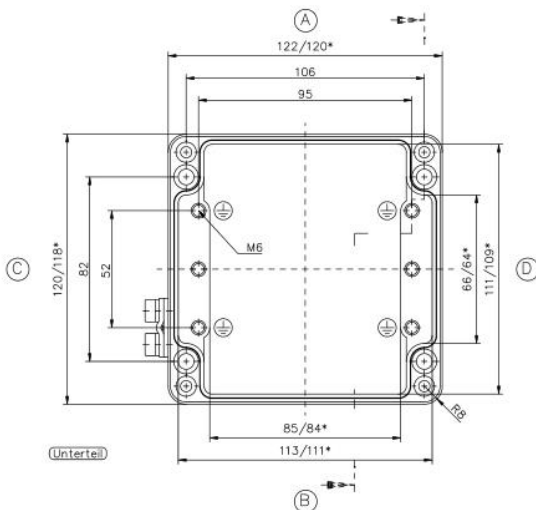

Unterteil

