

USB-OTG BUS-Port ESD Protection for $V_{BUS} = 28\text{ V}$

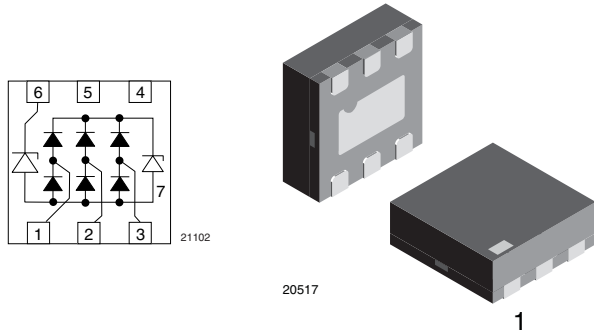

FEATURES

- Ultra compact LLP75-7L package
- Low package height < 0.6 mm
- 3-line USB ESD protection with max. working range = 5.5 V
- V_{BUS} -protection with 28 V working range
- Low leakage current
- Low load capacitance $C_D = 0.7\text{ pF}$
- ESD immunity to IEC 61000-4-2
± 15 kV contact discharge
± 15 kV air discharge
- Surge current acc. IEC 61000-4-5 $I_{PP} > 3\text{ A}$
- e4 - precious metal (e.g. Ag, Au, NiPd, NiPdAu) (no Sn)
- Material categorization: for definitions of compliance please see www.vishay.com/doc?99912



MARKING (example only)

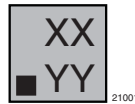

Dot = pin 1 marking
 XX = date code
 YY = type code (see table below)

DESIGN SUPPORT TOOLS

[click logo to get started](#)



ORDERING INFORMATION			
DEVICE NAME	ORDERING CODE	TAPED UNITS PER REEL (8 mm TAPE on 7" REEL)	MINIMUM ORDER QUANTITY
VBUS053CZ-HAF	VBUS053CZ-HAF-G-08	3000	15 000

PACKAGE DATA						
DEVICE NAME	PACKAGE NAME	TYPE CODE	WEIGHT	MOLDING COMPOUND FLAMMABILITY RATING	MOISTURE SENSITIVITY LEVEL	SOLDERING CONDITIONS
VBUS053CZ-HAF	LLP75-7L	UA	4.2 mg	UL 94 V-0	MSL level 1 (according J-STD-020)	Peak temperature max. 260 °C

ABSOLUTE MAXIMUM RATINGS VBUS053CZ-HAF				
PARAMETER	TEST CONDITIONS	SYMBOL	VALUE	UNIT
Data line D+, D-, ID: Pin 1, 2 and 3 to ground (pin 7)				
Peak pulse current	acc. IEC 61000-4-5; $t_p = 8/20\ \mu\text{s}$; single shot	I_{PPM}	3	A
Peak pulse power	acc. IEC 61000-4-5; $t_p = 8/20\ \mu\text{s}$; single shot	P_{PP}	54	W
ESD immunity	Contact discharge acc. IEC 61000-4-2; 10 pulses	V_{ESD}	± 15	kV
	Air discharge acc. IEC 61000-4-2; 10 pulses		± 15	kV
V_{BUS}: Pin 6 to ground (pin 7)				
Peak pulse current	acc. IEC 61000-4-5; $t_p = 8/20\ \mu\text{s}$; single shot	I_{PPM}	3	A
Peak pulse power	acc. IEC 61000-4-5; $t_p = 8/20\ \mu\text{s}$; single shot	P_{PP}	156	W
ESD immunity	Contact discharge acc. IEC 61000-4-2; 10 pulses	V_{ESD}	± 30	kV
	Air discharge acc. IEC 61000-4-2; 10 pulses		± 30	kV
Operating temperature	Junction temperature	T_J	-40 to +125	°C
Storage temperature		T_{STG}	-55 to +150	°C

ELECTRICAL CHARACTERISTICS VBUS053CZ-HAF All inputs (pin 1, 2, and 3) to ground (pin 7)						
PARAMETER	TEST CONDITIONS/REMARKS	SYMBOL	MIN.	TYP.	MAX.	UNIT
Protection paths	Number of line which can be protected	N_{channel}	-	-	3	lines
Reverse working voltage	Reverse stand-off voltage	V_{RWM}	-	-	5.5	V
Reverse voltage	at $I_{\text{R}} = 0.1 \mu\text{A}$	V_{R}	5.5	-	-	V
Reverse current	at $V_{\text{R}} = 3.3 \text{ V}$	I_{R}	-	-	0.02	μA
	at $V_{\text{R}} = 3.3 \text{ V}; T = 65 \text{ }^\circ\text{C}$	I_{R}	-	-	0.085	μA
	at $V_{\text{R}} = V_{\text{RWM}} = 5.5 \text{ V}$	I_{R}	-	-	0.1	μA
Forward voltage	at $I_{\text{F}} = 15 \text{ mA}$	V_{F}	0.7	-	1.2	V
Reverse breakdown voltage	at $I_{\text{R}} = 1 \text{ mA}$	V_{BR}	6.5	-	10	V
Reverse clamping voltage	at $I_{\text{PP}} = 1 \text{ A}; \text{acc. IEC 61000-4-5}$	V_{C}	-	10	12	V
	at $I_{\text{PP}} = 3 \text{ A}; \text{acc. IEC 61000-4-5}$	V_{C}	-	15	18	V
Forward clamping voltage	at $I_{\text{F}} = 3 \text{ A}; \text{acc. IEC 61000-4-5}$	V_{F}	-	3.4	4.1	V
Line capacitance	Test pin at $V_{\text{R}} = 0 \text{ V};$ any other I/O pin at $V_{\text{R}} = 3.3 \text{ V}; f = 1 \text{ MHz}$	C_{D}	-	0.7	1	pF
Line to line capacitance	Among pins 1, 2 and 3 at $V_{\text{R}} = 0 \text{ V}; f = 1 \text{ MHz}$	C_{D}	-	0.35	0.5	pF
Line symmetry	Difference of the line capacitance	dC_{D}	-	-	0.1	pF

Note

- Ratings at 25 °C ambient temperature, unless otherwise specified

ELECTRICAL CHARACTERISTICS VBUS (pin 6) to ground (pin 7)						
PARAMETER	TEST CONDITIONS/REMARKS	SYMBOL	MIN.	TYP.	MAX.	UNIT
Protection paths	Number of line which can be protected	N_{channel}	-	-	1	lines
Reverse working voltage	Reverse stand-off voltage	V_{RWM}	-	-	28	V
Reverse voltage	at $I_{\text{R}} = 0.1 \mu\text{A}$	V_{R}	28	-	-	V
Reverse current	at $V_{\text{R}} = V_{\text{RWM}} = 28 \text{ V}$	I_{R}	-	-	100	nA
Forward voltage	at $I_{\text{F}} = 10 \text{ mA}$	V_{F}	0.6	0.75	0.9	V
Reverse breakdown voltage	at $I_{\text{R}} = 1 \text{ mA}$	V_{BR}	32	-	40	V
Reverse clamping voltage	at $I_{\text{PP}} = 1 \text{ A}; \text{acc. IEC 61000-4-5}; T = 25 \text{ }^\circ\text{C}$	V_{C}	-	37	45	V
	at $I_{\text{PP}} = 3 \text{ A}; \text{acc. IEC 61000-4-5}; T = 25 \text{ }^\circ\text{C}$	V_{C}	-	42	52	V
Forward clamping voltage	at $I_{\text{F}} = 3 \text{ A}; \text{acc. IEC 61000-4-5}$	V_{F}	-	-	2.2	V
Line capacitance	at $V_{\text{R}} = 0 \text{ V}; f = 1 \text{ MHz}$	C_{D}	-	31	40	pF

Note

- Ratings at 25 °C ambient temperature, unless otherwise specified

APPLICATION NOTE

The VBUS053CZ-HAF is intended as an ESD protection and transient voltage suppressor for one USB-OTG port.

The LLP75-7L package contains two separate dies which are mounted on a common ground plane (pin 7).

The high-speed data lines D-, D+ and ID, are connected to any of the pins no. 1 to 3. As long as the signal voltage on the data lines is between the ground- and the 5 V working range, the low capacitance PN-diodes offer a very high isolation to ground and to the other data lines. But as soon as any transient signal like an ESD signal, exceeds this working range of 5 V in either the positive or negative direction, one of the PN-diodes gets into the forward mode and clamps the transient either to ground or to the avalanche break through level. An extra avalanche diode (separate die) clamps the supply line voltage (V_{BUS} at pin 6) above the 28 V working range to ground (pin 7). Due to the “two die construction” the V_{BUS} line has a very high isolation to the data lines. In case of a destructive transient signal, i.e. coming from a charger, the data lines will not be influenced.

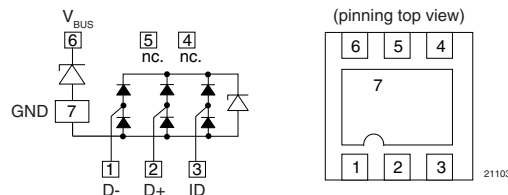
Remark:

The input pins no. 1, 2 and 3 are symmetrical. Each of the data signals D-, D+ and ID can be connected to pin 1, 2 or 3



TYPICAL CHARACTERISTICS (T_{amb} = 25 °C, unless otherwise specified)

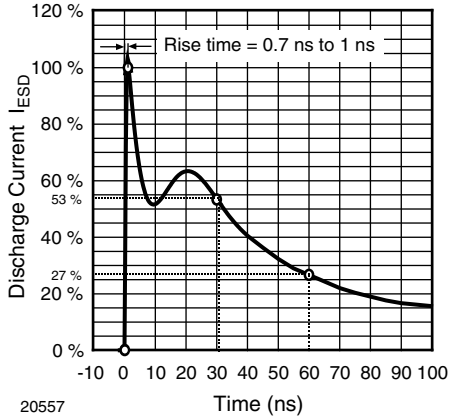

Fig. 1 - ESD Discharge Current Wave Form acc. IEC 61000-4-2 (330 Ω/150 pF)

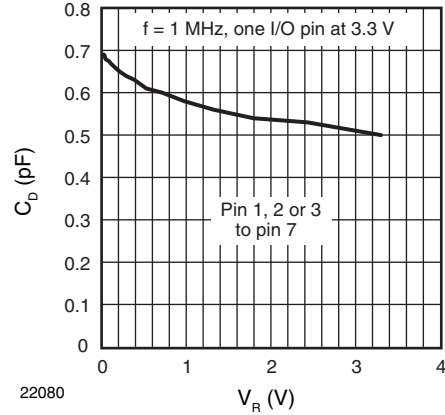

Fig. 4 - Typical Capacitance C_D vs. Reverse Voltage V_R

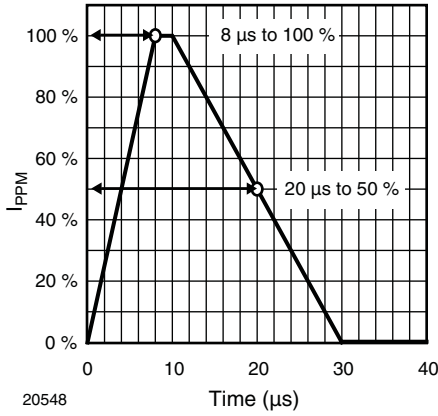

Fig. 2 - 8/20 μs Peak Pulse Current Wave Form acc. IEC 61000-4-5

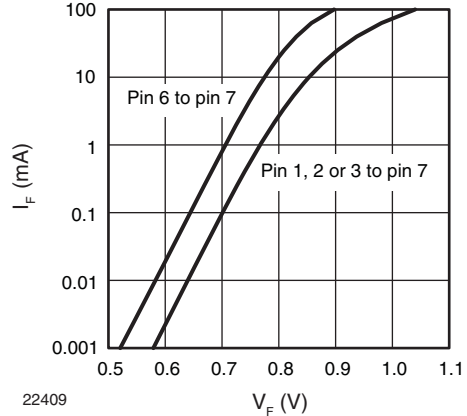

Fig. 5 - Typical Forward Current I_F vs. Forward Voltage V_F

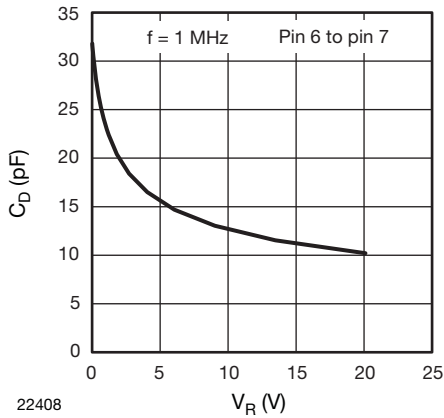

Fig. 3 - Typical Capacitance C_D vs. Reverse Voltage V_R

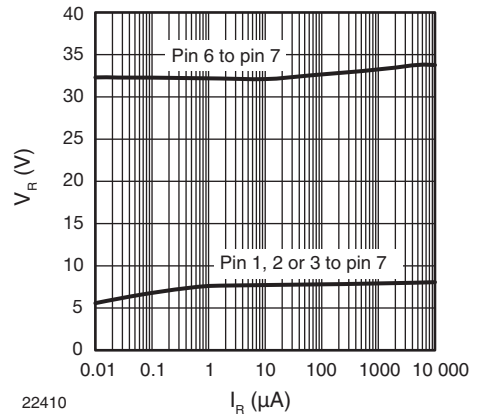

Fig. 6 - Typical Reverse Voltage V_R vs. Reverse Current I_R

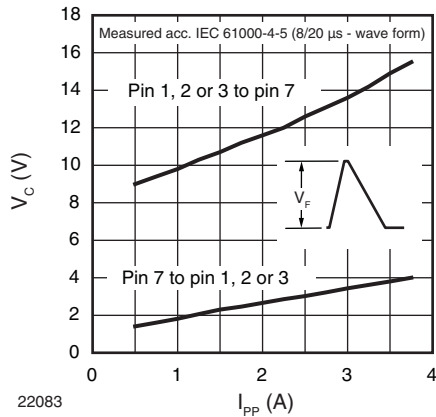

Fig. 7 - Typical Peak Clamping Voltage V_C vs. Peak Pulse Current I_{PP}

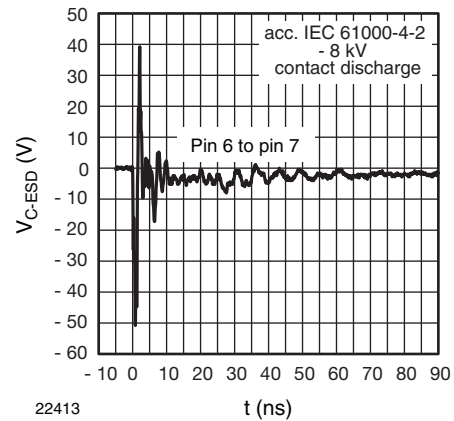

Fig. 10 - Typical Clamping Performance at - 8 kV Contact Discharge (acc. IEC 61000-4-2)

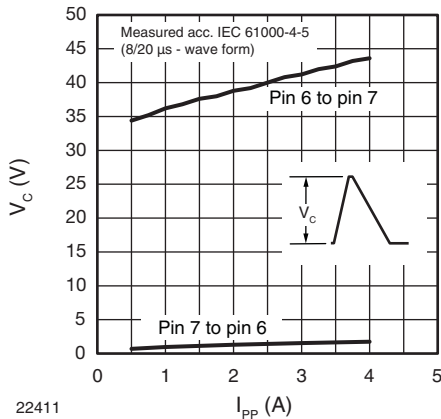

Fig. 8 - Typical Peak Clamping Voltage V_C vs. Peak Pulse Current I_{PP}

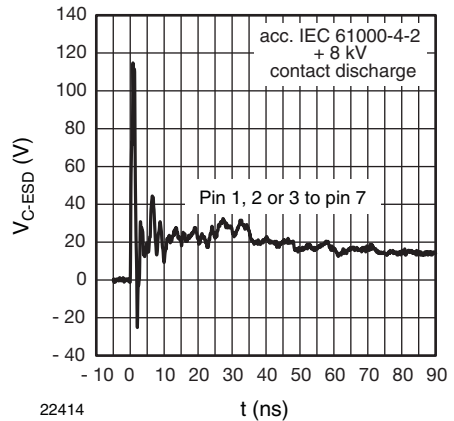

Fig. 11 - Typical Clamping Performance at + 8 kV Contact Discharge (acc. IEC 61000-4-2)

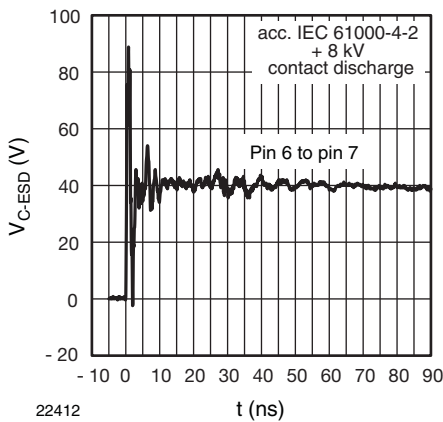

Fig. 9 - Typical Clamping Performance at + 8 kV Contact Discharge (acc. IEC 61000-4-2)

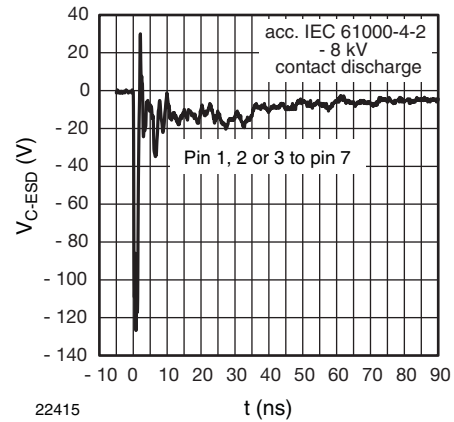

Fig. 12 - Typical Clamping Performance at - 8 kV Contact Discharge (acc. IEC 61000-4-2)

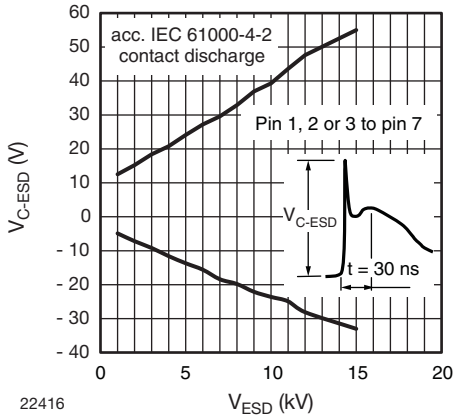

Fig. 13 - Typical Clamping Voltage at after 30 ns of ESD Contact Discharge (acc. IEC 61000-4-2)

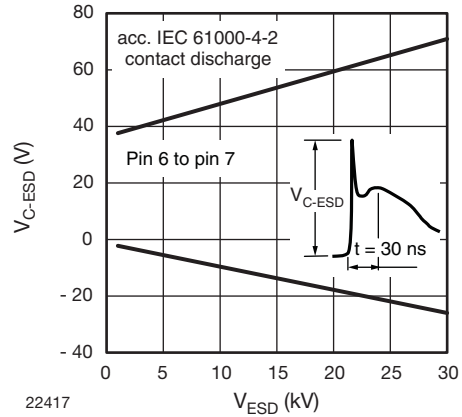
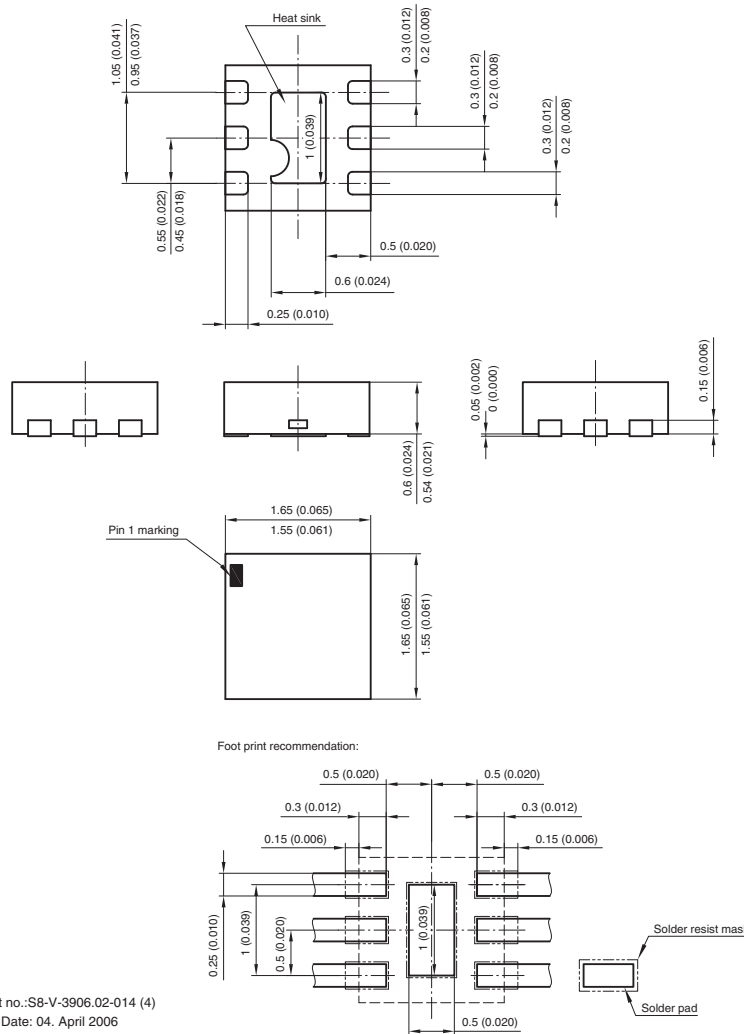
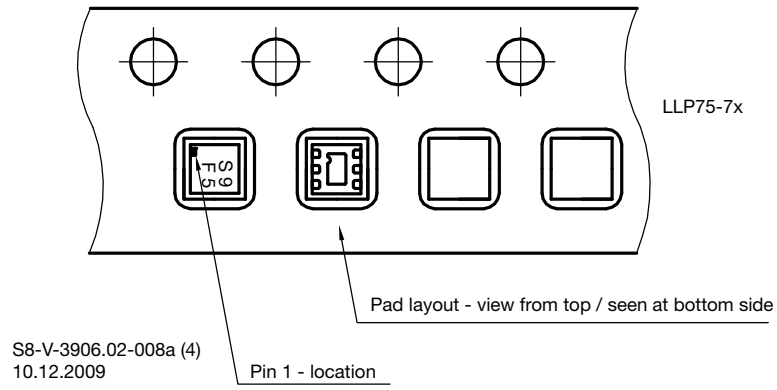

Fig. 14 - Typical Clamping Voltage at after 30 ns of ESD Contact Discharge (acc. IEC 61000-4-2)

PACKAGE DIMENSIONS in millimeters (inches): **LLP75-7L**



Document no.:S8-V-3906.02-014 (4)
Created - Date: 04. April 2006
20500





Disclaimer

ALL PRODUCT, PRODUCT SPECIFICATIONS AND DATA ARE SUBJECT TO CHANGE WITHOUT NOTICE TO IMPROVE RELIABILITY, FUNCTION OR DESIGN OR OTHERWISE.

Vishay Intertechnology, Inc., its affiliates, agents, and employees, and all persons acting on its or their behalf (collectively, "Vishay"), disclaim any and all liability for any errors, inaccuracies or incompleteness contained in any datasheet or in any other disclosure relating to any product.

Vishay makes no warranty, representation or guarantee regarding the suitability of the products for any particular purpose or the continuing production of any product. To the maximum extent permitted by applicable law, Vishay disclaims (i) any and all liability arising out of the application or use of any product, (ii) any and all liability, including without limitation special, consequential or incidental damages, and (iii) any and all implied warranties, including warranties of fitness for particular purpose, non-infringement and merchantability.

Statements regarding the suitability of products for certain types of applications are based on Vishay's knowledge of typical requirements that are often placed on Vishay products in generic applications. Such statements are not binding statements about the suitability of products for a particular application. It is the customer's responsibility to validate that a particular product with the properties described in the product specification is suitable for use in a particular application. Parameters provided in datasheets and / or specifications may vary in different applications and performance may vary over time. All operating parameters, including typical parameters, must be validated for each customer application by the customer's technical experts. Product specifications do not expand or otherwise modify Vishay's terms and conditions of purchase, including but not limited to the warranty expressed therein.

Except as expressly indicated in writing, Vishay products are not designed for use in medical, life-saving, or life-sustaining applications or for any other application in which the failure of the Vishay product could result in personal injury or death. Customers using or selling Vishay products not expressly indicated for use in such applications do so at their own risk. Please contact authorized Vishay personnel to obtain written terms and conditions regarding products designed for such applications.

No license, express or implied, by estoppel or otherwise, to any intellectual property rights is granted by this document or by any conduct of Vishay. Product names and markings noted herein may be trademarks of their respective owners.