

Fast Soft Recovery Rectifier Diode, 40 A

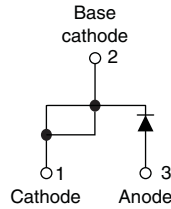

TO-247AC modified



FEATURES

- Glass passivated pellet chip junction
- 150 °C max. operating junction temperature
- Low forward voltage drop and short reverse recovery time
- Designed and qualified according to JEDEC®-JESD 47
- Material categorization: for definitions of compliance please see www.vishay.com/doc?99912



RoHS
COMPLIANT
HALOGEN
FREE
Available

| PRODUCT SUMMARY | |
|-----------------|----------------------------|
| Package | TO-247AC modified (2 pins) |
| $I_{F(AV)}$ | 40 A |
| V_R | 200 V, 400 V, 600 V |
| V_F at I_F | 1.25 V |
| I_{FSM} | 475 A |
| t_{rr} | 60 ns |
| T_J max. | 150 °C |
| Diode variation | Single die |
| Snap factor | 0.5 |

APPLICATIONS

These devices are intended for use in output rectification and freewheeling in inverters, choppers and converters as well as in input rectification where severe restrictions on conducted EMI should be met.

DESCRIPTION

The VS-40EPF0... fast soft recovery rectifier series has been optimized for combined short reverse recovery time and low forward voltage drop.

The glass passivation ensures stable reliable operation in the most severe temperature and power cycling conditions.

| MAJOR RATINGS AND CHARACTERISTICS | | | |
|-----------------------------------|----------------------------|-------------|-------|
| SYMBOL | CHARACTERISTICS | VALUES | UNITS |
| $I_{F(AV)}$ | Sinusoidal waveform | 40 | A |
| V_{RRM} | | 200 to 600 | V |
| I_{FSM} | | 475 | A |
| V_F | 10 A, $T_J = 25\text{ °C}$ | 1 | V |
| t_{rr} | 1 A, - 100 A/ μ s | 60 | ns |
| T_J | | -40 to +150 | °C |

| VOLTAGE RATINGS | | | |
|------------------------------|---|--|---------------------------|
| PART NUMBER | V_{RRM} , MAXIMUM PEAK REVERSE VOLTAGE V | V_{RSM} , MAXIMUM NON-REPETITIVE PEAK REVERSE VOLTAGE V | I_{RRM} AT 150 °C mA |
| VS-40EPF02PbF, VS-40EPF02-M3 | 200 | 300 | 8 |
| VS-40EPF04PbF, VS-40EPF04-M3 | 400 | 500 | |
| VS-40EPF06PbF, VS-40EPF06-M3 | 600 | 700 | |

| ABSOLUTE MAXIMUM RATINGS | | | | |
|---|---------------|--|--------|---------------------------|
| PARAMETER | SYMBOL | TEST CONDITIONS | VALUES | UNITS |
| Maximum average forward current | $I_{F(AV)}$ | $T_C = 105\text{ °C}$, 180° conduction half sine wave | 40 | A |
| Maximum peak one cycle non-repetitive surge current | I_{FSM} | 10 ms sine pulse, rated V_{RRM} applied | 400 | |
| | | 10 ms sine pulse, no voltage reapplied | 475 | |
| Maximum I^2t for fusing | I^2t | 10 ms sine pulse, rated V_{RRM} applied | 800 | A ² s |
| | | 10 ms sine pulse, no voltage reapplied | 1131 | |
| Maximum $I^2\sqrt{t}$ for fusing | $I^2\sqrt{t}$ | $t = 0.1\text{ ms to }10\text{ ms}$, no voltage reapplied | 11 310 | A ² \sqrt{s} |



| ELECTRICAL SPECIFICATIONS | | | | | |
|---------------------------------|-------------|--|-------------------------------|--------|------------------|
| PARAMETER | SYMBOL | TEST CONDITIONS | | VALUES | UNITS |
| Maximum forward voltage drop | V_{FM} | 40 A, $T_J = 25\text{ }^\circ\text{C}$ | | 1.25 | V |
| Forward slope resistance | r_t | $T_J = 150\text{ }^\circ\text{C}$ | | 4.4 | $\text{m}\Omega$ |
| Threshold voltage | $V_{F(TO)}$ | | | 1.1 | V |
| Maximum reverse leakage current | I_{RM} | $T_J = 25\text{ }^\circ\text{C}$ | $V_R = \text{Rated } V_{RRM}$ | 0.1 | mA |
| | | $T_J = 150\text{ }^\circ\text{C}$ | | 8.0 | |

| RECOVERY CHARACTERISTICS | | | | |
|--------------------------|----------|---|--------|---------------|
| PARAMETER | SYMBOL | TEST CONDITIONS | VALUES | UNITS |
| Reverse recovery time | t_{rr} | I_F at 40 A _{pk} 25 A/ μs 25 $^\circ\text{C}$ | 180 | ns |
| Reverse recovery current | I_{rr} | | 3.2 | A |
| Reverse recovery charge | Q_{rr} | | 0.5 | μC |
| Snap factor | S | | 0.5 | |

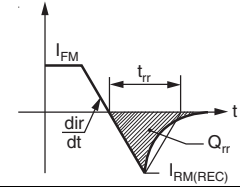

| THERMAL - MECHANICAL SPECIFICATIONS | | | | | |
|---|----------------|--------------------------------------|--|-------------|--|
| PARAMETER | SYMBOL | TEST CONDITIONS | | VALUES | UNITS |
| Maximum junction and storage temperature range | T_J, T_{Stg} | | | -40 to +150 | $^\circ\text{C}$ |
| Maximum thermal resistance, junction to case | R_{thJC} | DC operation | | 0.6 | $^\circ\text{C}/\text{W}$ |
| Maximum thermal resistance, junction to ambient | R_{thJA} | | | 40 | |
| Typical thermal resistance, case to heatsink | R_{thCS} | Mounting surface, smooth and greased | | 0.2 | |
| Approximate weight | | | | 6 | g |
| | | | | 0.21 | oz. |
| Mounting torque | minimum | | | 6 (5) | $\text{kgf} \cdot \text{cm}$ ($\text{lbf} \cdot \text{in}$) |
| | maximum | | | 12 (10) | |
| Marking device | | Case style TO-247AC modified (JEDEC) | | 40EPF02 | |
| | | | | 40EPF04 | |
| | | | | 40EPF06 | |

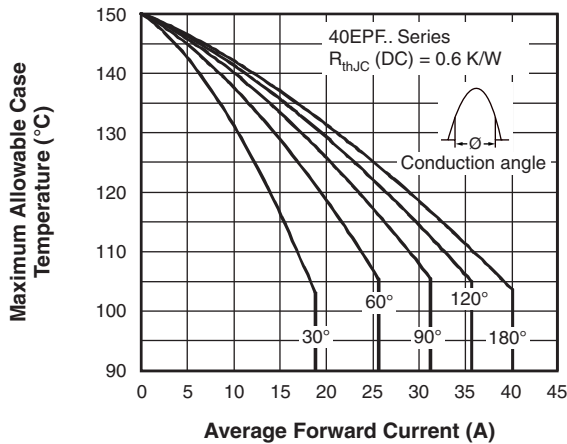

Fig. 1 - Current Rating Characteristics

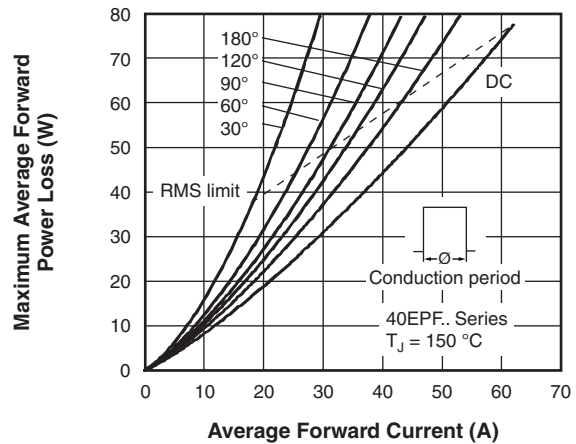

Fig. 4 - Forward Power Loss Characteristics

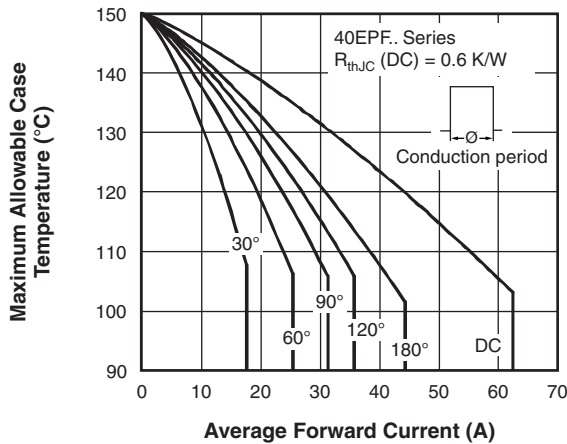

Fig. 2 - Current Rating Characteristics

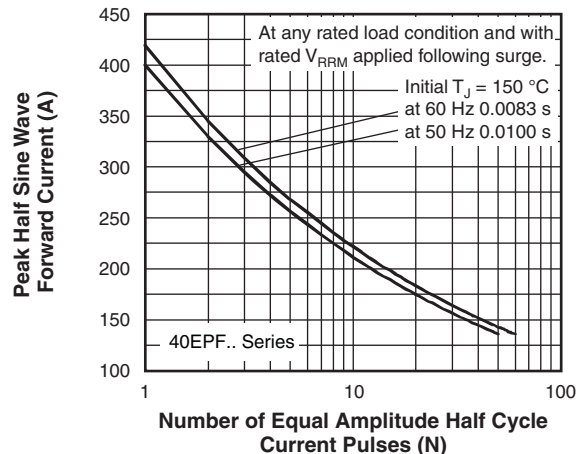

Fig. 5 - Maximum Non-Repetitive Surge Current

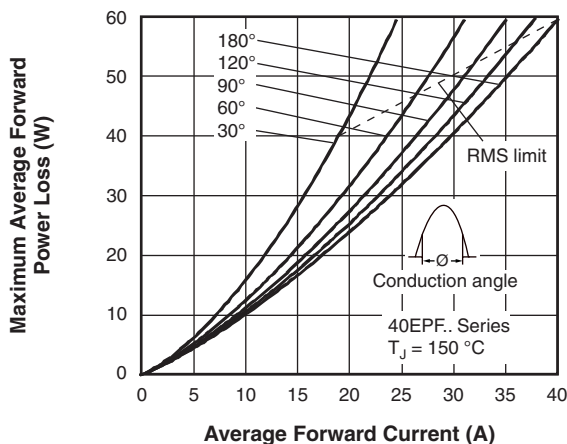

Fig. 3 - Forward Power Loss Characteristics

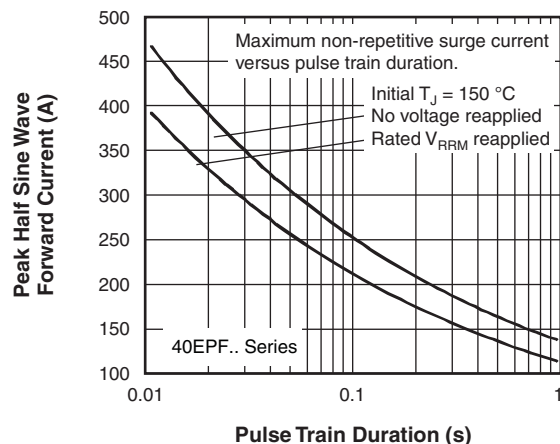

Fig. 6 - Maximum Non-Repetitive Surge Current

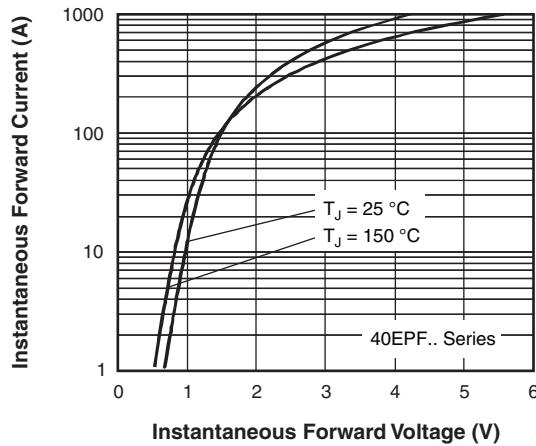

Fig. 7 - Forward Voltage Drop Characteristics

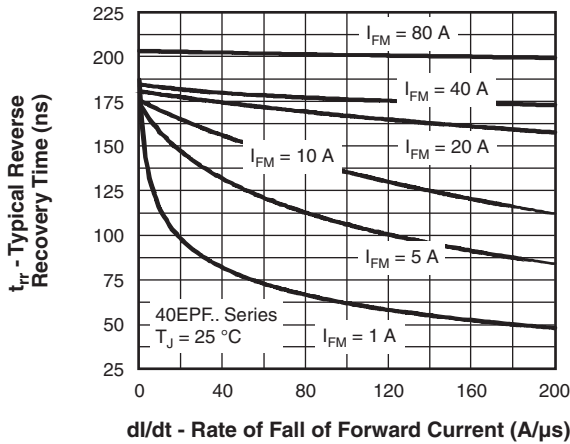

Fig. 8 - Recovery Time Characteristics, $T_J = 25\text{ }^\circ\text{C}$

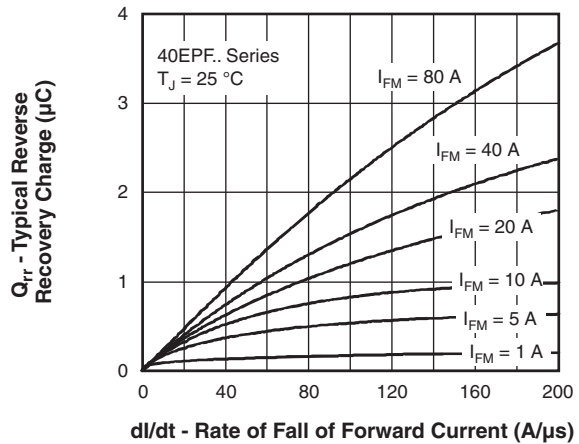

Fig. 10 - Recovery Charge Characteristics, $T_J = 25\text{ }^\circ\text{C}$

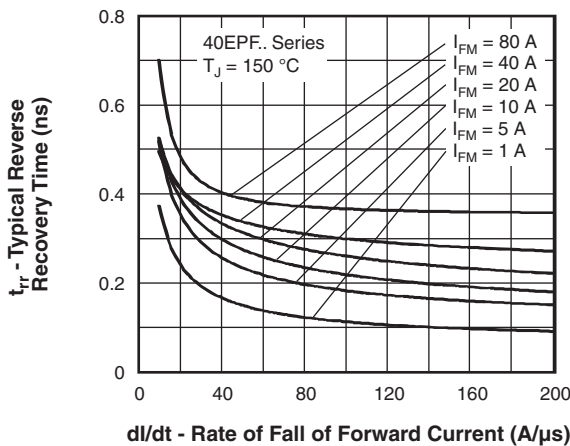

Fig. 9 - Recovery Time Characteristics, $T_J = 150\text{ }^\circ\text{C}$

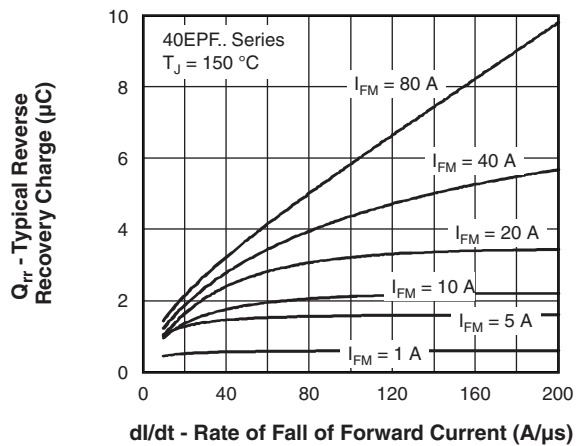

Fig. 11 - Recovery Charge Characteristics, $T_J = 150\text{ }^\circ\text{C}$

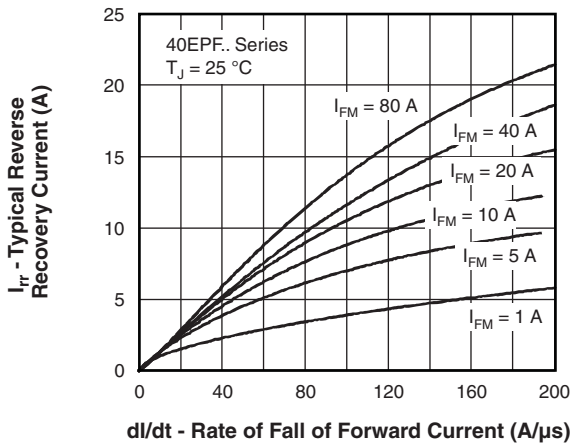

Fig. 12 - Recovery Current Characteristics, $T_J = 25\text{ }^\circ\text{C}$

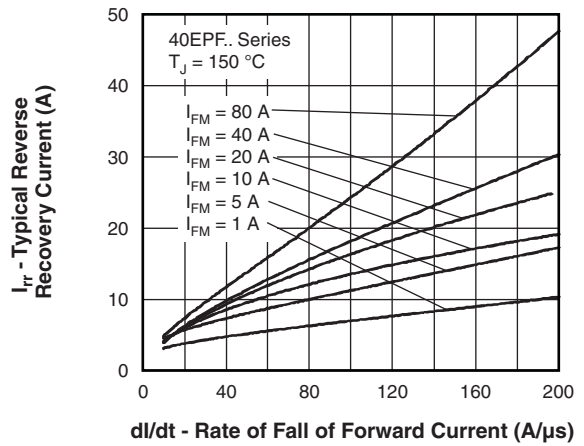

Fig. 13 - Recovery Current Characteristics, $T_J = 150\text{ }^\circ\text{C}$

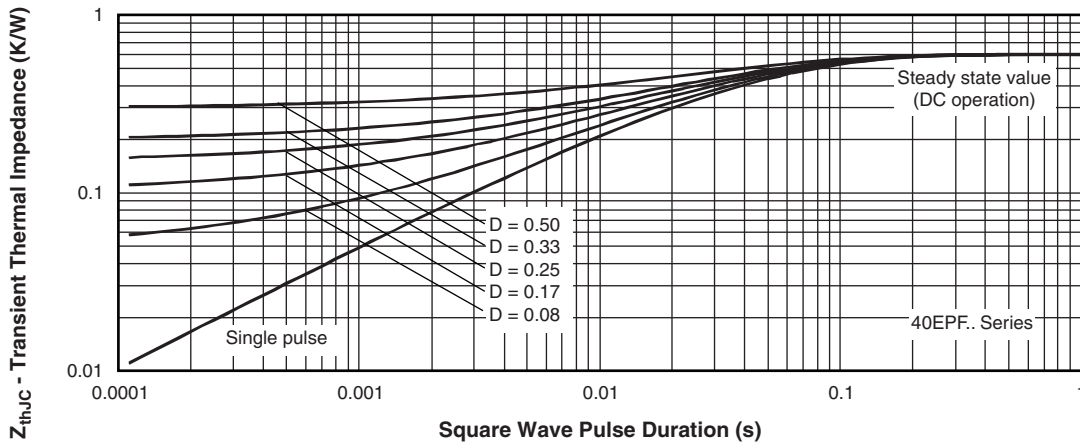
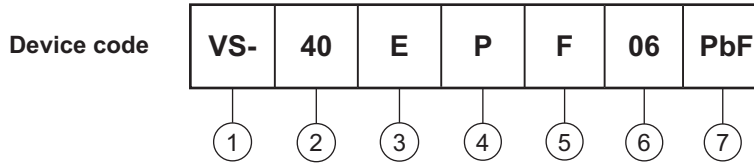

Fig. 14 - Thermal Impedance Z_{thJC} Characteristics



ORDERING INFORMATION TABLE



- 1** - Vishay Semiconductors product
- 2** - Current rating (40 = 40 A)
- 3** - Circuit configuration:
E = single diode
- 4** - Package:
P = TO-247AC modified
- 5** - Type of silicon:
F = fast diode
- 6** - Voltage code x 100 = V_{RRM}

| |
|------------|
| 02 = 200 V |
| 04 = 400 V |
| 06 = 600 V |
- 7** - Environmental digit:
 - PbF = lead (Pb)-free and RoHS-compliant
 - -M3 = halogen-free, RoHS-compliant, and terminations lead (Pb)-free

| ORDERING INFORMATION (Example) | | | |
|--------------------------------|------------------|------------------------|--------------------------|
| PREFERRED P/N | QUANTITY PER T/R | MINIMUM ORDER QUANTITY | PACKAGING DESCRIPTION |
| VS-40EPF02PbF | 25 | 500 | Antistatic plastic tubes |
| VS-40EPF02-M3 | 25 | 500 | Antistatic plastic tubes |
| VS-40EPF04PbF | 25 | 500 | Antistatic plastic tubes |
| VS-40EPF04-M3 | 25 | 500 | Antistatic plastic tubes |
| VS-40EPF06PbF | 25 | 500 | Antistatic plastic tubes |
| VS-40EPF06-M3 | 25 | 500 | Antistatic plastic tubes |

| LINKS TO RELATED DOCUMENTS | |
|----------------------------|---|
| Dimensions | www.vishay.com/doc?95541 |
| Part marking information | TO-247AC modified PbF www.vishay.com/doc?95255 |
| | TO-247AC modified -M3 www.vishay.com/doc?95442 |
| SPIICE model | www.vishay.com/doc?95274 |

TO-247

DIMENSIONS in millimeters and inches

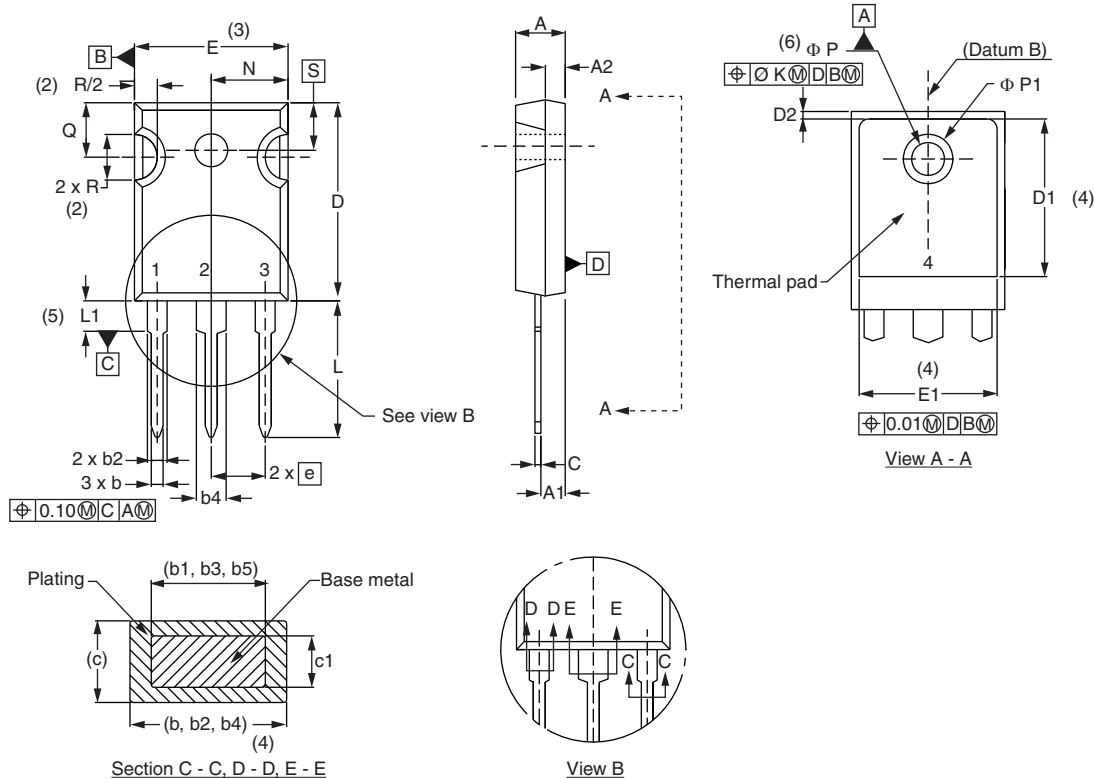

| SYMBOL | MILLIMETERS | | INCHES | | NOTES | SYMBOL | MILLIMETERS | | INCHES | | NOTES |
|--------|-------------|-------|--------|-------|-------|-----------|-------------|-------|-----------|-------|-------|
| | MIN. | MAX. | MIN. | MAX. | | | MIN. | MAX. | MIN. | MAX. | |
| A | 4.65 | 5.31 | 0.183 | 0.209 | | D2 | 0.51 | 1.30 | 0.020 | 0.051 | |
| A1 | 2.21 | 2.59 | 0.087 | 0.102 | | E | 15.29 | 15.87 | 0.602 | 0.625 | 3 |
| A2 | 1.50 | 2.49 | 0.059 | 0.098 | | E1 | 13.72 | - | 0.540 | - | |
| b | 0.99 | 1.40 | 0.039 | 0.055 | | e | 5.46 BSC | | 0.215 BSC | | |
| b1 | 0.99 | 1.35 | 0.039 | 0.053 | | ϕK | 2.54 | | 0.010 | | |
| b2 | 1.65 | 2.39 | 0.065 | 0.094 | | L | 14.20 | 16.10 | 0.559 | 0.634 | |
| b3 | 1.65 | 2.34 | 0.065 | 0.092 | | L1 | 3.71 | 4.29 | 0.146 | 0.169 | |
| b4 | 2.59 | 3.43 | 0.102 | 0.135 | | N | 7.62 BSC | | 0.3 | | |
| b5 | 2.59 | 3.38 | 0.102 | 0.133 | | ϕP | 3.56 | 3.66 | 0.14 | 0.144 | |
| c | 0.38 | 0.89 | 0.015 | 0.035 | | $\phi P1$ | - | 6.98 | - | 0.275 | |
| c1 | 0.38 | 0.84 | 0.015 | 0.033 | | Q | 5.31 | 5.69 | 0.209 | 0.224 | |
| D | 19.71 | 20.70 | 0.776 | 0.815 | 3 | R | 4.52 | 5.49 | 0.178 | 0.216 | |
| D1 | 13.08 | - | 0.515 | - | 4 | S | 5.51 BSC | | 0.217 BSC | | |

Notes

- (1) Dimensioning and tolerancing per ASME Y14.5M-1994
- (2) Contour of slot optional
- (3) Dimension D and E do not include mold flash. Mold flash shall not exceed 0.127 mm (0.005") per side. These dimensions are measured at the outermost extremes of the plastic body
- (4) Thermal pad contour optional with dimensions D1 and E1
- (5) Lead finish uncontrolled in L1
- (6) ϕP to have a maximum draft angle of 1.5 to the top of the part with a maximum hole diameter of 3.91 mm (0.154")
- (7) Outline conforms to JEDEC® outline TO-247 with exception of dimension c



TO-247 modified

DIMENSIONS in millimeters and inches

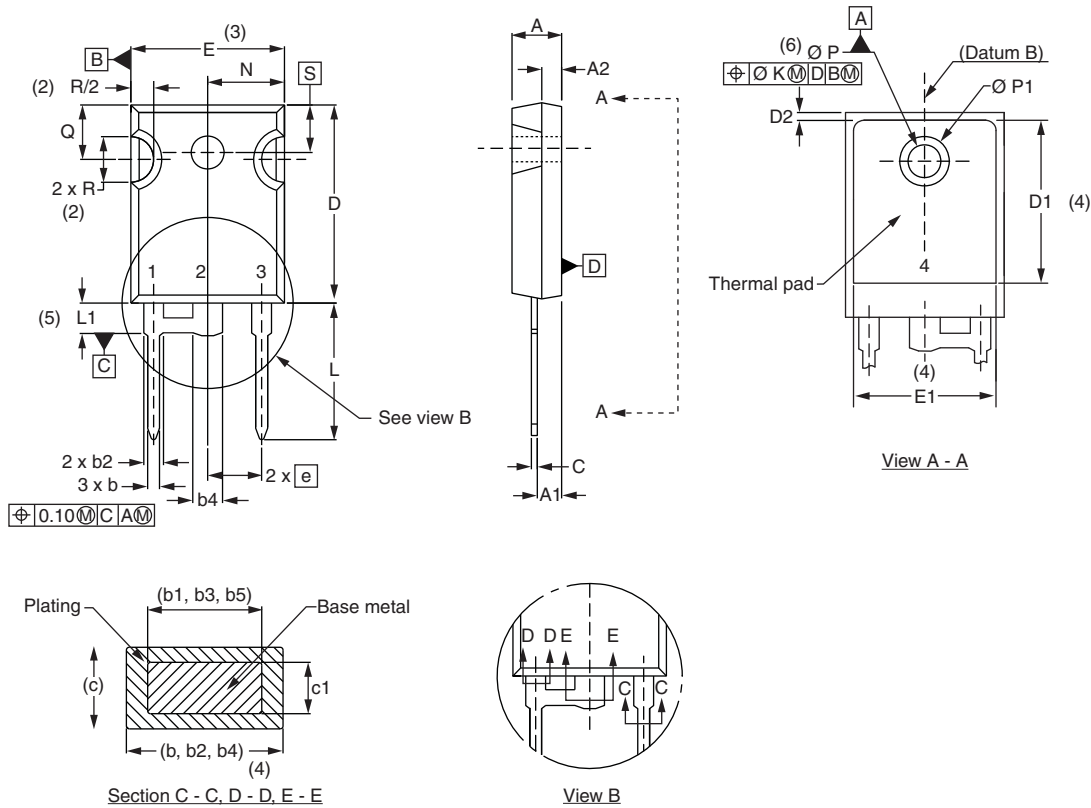

| SYMBOL | MILLIMETERS | | INCHES | | NOTES | SYMBOL | MILLIMETERS | | INCHES | | NOTES |
|--------|-------------|-------|--------|-------|-------|--------|-------------|-------|-----------|-------|-------|
| | MIN. | MAX. | MIN. | MAX. | | | MIN. | MAX. | MIN. | MAX. | |
| A | 4.65 | 5.31 | 0.183 | 0.209 | | D2 | 0.51 | 1.30 | 0.020 | 0.051 | |
| A1 | 2.21 | 2.59 | 0.087 | 0.102 | | E | 15.29 | 15.87 | 0.602 | 0.625 | 3 |
| A2 | 1.50 | 2.49 | 0.059 | 0.098 | | E1 | 13.72 | - | 0.540 | - | |
| b | 0.99 | 1.40 | 0.039 | 0.055 | | e | 5.46 BSC | | 0.215 BSC | | |
| b1 | 0.99 | 1.35 | 0.039 | 0.053 | | Ø K | 2.54 | | 0.010 | | |
| b2 | 1.65 | 2.39 | 0.065 | 0.094 | | L | 14.20 | 16.10 | 0.559 | 0.634 | |
| b3 | 1.65 | 2.34 | 0.065 | 0.092 | | L1 | 3.71 | 4.29 | 0.146 | 0.169 | |
| b4 | 2.59 | 3.43 | 0.102 | 0.135 | | N | 7.62 BSC | | 0.3 | | |
| b5 | 2.59 | 3.38 | 0.102 | 0.133 | | Ø P | 3.56 | 3.66 | 0.14 | 0.144 | |
| c | 0.38 | 0.89 | 0.015 | 0.035 | | Ø P1 | - | 6.98 | - | 0.275 | |
| c1 | 0.38 | 0.84 | 0.015 | 0.033 | | Q | 5.31 | 5.69 | 0.209 | 0.224 | |
| D | 19.71 | 20.70 | 0.776 | 0.815 | 3 | R | 4.52 | 5.49 | 0.178 | 0.216 | |
| D1 | 13.08 | - | 0.515 | - | 4 | S | 5.51 BSC | | 0.217 BSC | | |

Notes

- (1) Dimensioning and tolerance per ASME Y14.5M-1994
- (2) Contour of slot optional
- (3) Dimension D and E do not include mold flash. Mold flash shall not exceed 0.127 mm (0.005") per side. These dimensions are measured at the outermost extremes of the plastic body
- (4) Thermal pad contour optional with dimensions D1 and E1
- (5) Lead finish uncontrolled in L1
- (6) Ø P to have a maximum draft angle of 1.5 to the top of the part with a maximum hole diameter of 3.91 mm (0.154")
- (7) Outline conforms to JEDEC® outline TO-247 with exception of dimension c



Disclaimer

ALL PRODUCT, PRODUCT SPECIFICATIONS AND DATA ARE SUBJECT TO CHANGE WITHOUT NOTICE TO IMPROVE RELIABILITY, FUNCTION OR DESIGN OR OTHERWISE.

Vishay Intertechnology, Inc., its affiliates, agents, and employees, and all persons acting on its or their behalf (collectively, "Vishay"), disclaim any and all liability for any errors, inaccuracies or incompleteness contained in any datasheet or in any other disclosure relating to any product.

Vishay makes no warranty, representation or guarantee regarding the suitability of the products for any particular purpose or the continuing production of any product. To the maximum extent permitted by applicable law, Vishay disclaims (i) any and all liability arising out of the application or use of any product, (ii) any and all liability, including without limitation special, consequential or incidental damages, and (iii) any and all implied warranties, including warranties of fitness for particular purpose, non-infringement and merchantability.

Statements regarding the suitability of products for certain types of applications are based on Vishay's knowledge of typical requirements that are often placed on Vishay products in generic applications. Such statements are not binding statements about the suitability of products for a particular application. It is the customer's responsibility to validate that a particular product with the properties described in the product specification is suitable for use in a particular application. Parameters provided in datasheets and/or specifications may vary in different applications and performance may vary over time. All operating parameters, including typical parameters, must be validated for each customer application by the customer's technical experts. Product specifications do not expand or otherwise modify Vishay's terms and conditions of purchase, including but not limited to the warranty expressed therein.

Except as expressly indicated in writing, Vishay products are not designed for use in medical, life-saving, or life-sustaining applications or for any other application in which the failure of the Vishay product could result in personal injury or death. Customers using or selling Vishay products not expressly indicated for use in such applications do so at their own risk. Please contact authorized Vishay personnel to obtain written terms and conditions regarding products designed for such applications.

No license, express or implied, by estoppel or otherwise, to any intellectual property rights is granted by this document or by any conduct of Vishay. Product names and markings noted herein may be trademarks of their respective owners.

Material Category Policy

Vishay Intertechnology, Inc. hereby certifies that all its products that are identified as RoHS-Compliant fulfill the definitions and restrictions defined under Directive 2011/65/EU of The European Parliament and of the Council of June 8, 2011 on the restriction of the use of certain hazardous substances in electrical and electronic equipment (EEE) - recast, unless otherwise specified as non-compliant.

Please note that some Vishay documentation may still make reference to RoHS Directive 2002/95/EC. We confirm that all the products identified as being compliant to Directive 2002/95/EC conform to Directive 2011/65/EU.

Vishay Intertechnology, Inc. hereby certifies that all its products that are identified as Halogen-Free follow Halogen-Free requirements as per JEDEC JS709A standards. Please note that some Vishay documentation may still make reference to the IEC 61249-2-21 definition. We confirm that all the products identified as being compliant to IEC 61249-2-21 conform to JEDEC JS709A standards.