

APPROVED BY: DATE: MFG. ENG. QA

NOTES:

1. ALL PARTS ARE BULK PACKED.
2. REFER TO DRAWING HPMCSTD FOR CONTACT PATTERNS.
3. ALL DIMENSIONS ARE REFERENCE ONLY IN INCHES [mm], WITHIN ±0.015 UNLESS OTHERWISE NOTED.

ASS'Y P/N	CONTACT QTY.	CABLE O.D. RANGE
W18982-5SG-P-518	5	0.18 - 0.20 [4.6 - 5.1]
W18982-5SG-P-521	5	0.21 - 0.22 [5.3 - 5.6]
W18982-5SG-P-522	5	0.22 - 0.23 [5.6 - 5.8]
W18982-6SG-P-518	6	0.18 - 0.20 [4.6 - 5.1]
W18982-6SG-P-521	6	0.21 - 0.22 [5.3 - 5.6]
W18982-6SG-P-522	6	0.22 - 0.23 [5.6 - 5.8]
W18982-7SG-P-518	7	0.18 - 0.20 [4.6 - 5.1]
W18982-7SG-P-521	7	0.21 - 0.22 [5.3 - 5.6]
W18982-7SG-P-522	7	0.22 - 0.23 [5.6 - 5.8]
W18982-XSG-P-5XX		

CUSTOMER PRINT

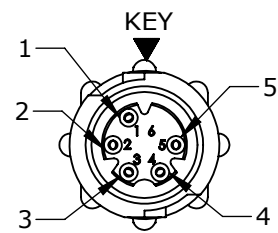

FACE VIEW  
W18982-5SG-P-5XX  
5 POSITION

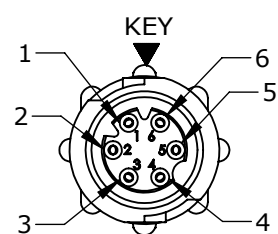

FACE VIEW  
W18982-6SG-P-5XX  
6 POSITION

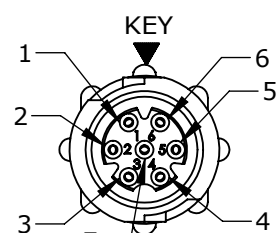

FACE VIEW  
W18982-7SG-P-5XX  
7 POSITION

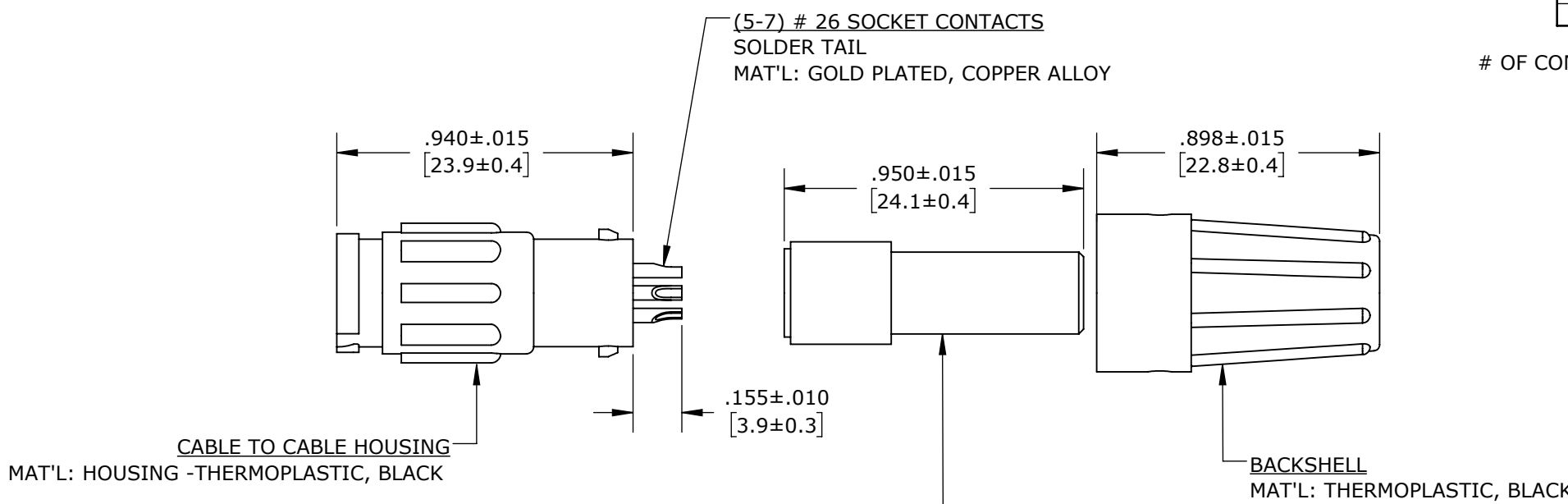

# OF CONTACTS

GROMMET SIZE = CABLE O.D. RANGE:  
518 = 0.18 - 0.20 [4.6 - 5.1]  
521 = 0.21 - 0.22 [5.3 - 5.6]  
522 = 0.22 - 0.23 [5.6 - 5.8]

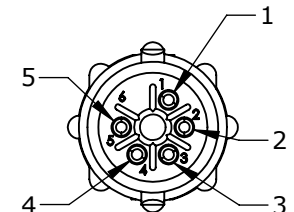

WIRING VIEW  
W18982-5SG-P-5XX

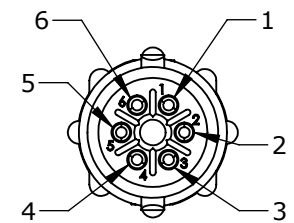

WIRING VIEW  
W18982-6SG-P-5XX

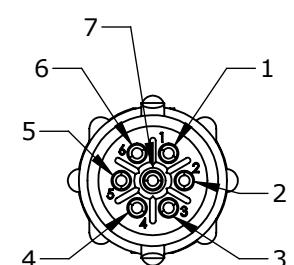

WIRING VIEW  
W18982-7SG-P-5XX

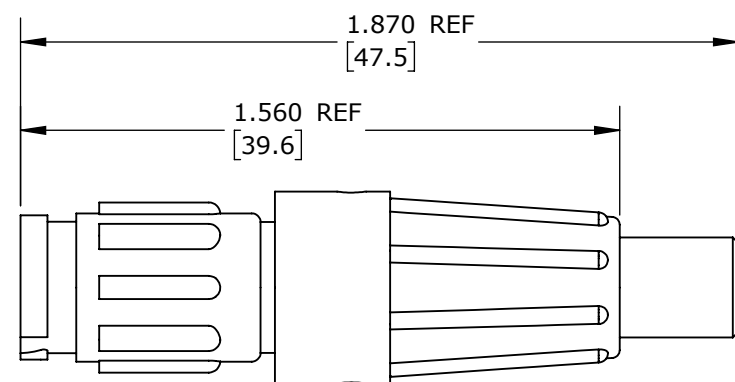

ASSEMBLED VIEW  
FOR CUSTOMER REF. ONLY

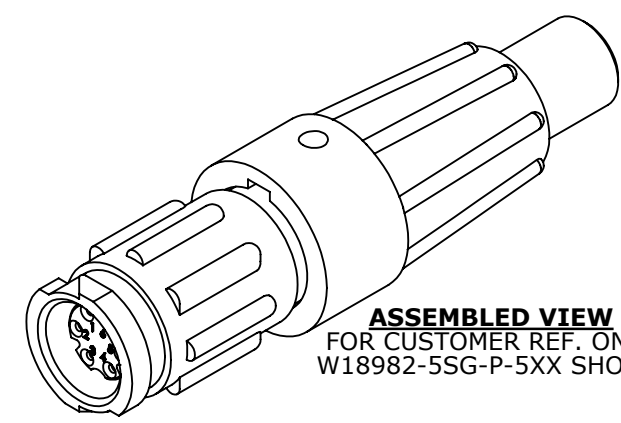

ASSEMBLED VIEW  
FOR CUSTOMER REF. ONLY  
W18982-5SG-P-5XX SHOWN

CUSTOMER APPROVAL

THIS DOCUMENT CONTAINS CONFIDENTIAL INFORMATION PROPRIETARY TO CONXALL CORPORATION. ANY REPRODUCTION, DISCLOSURE, OR USE OF THIS DOCUMENT /INFORMATION IS EXPRESSLY PROHIBITED UNLESS AUTHORIZED IN WRITING BY CONXALL CORPORATION.

APPROVED BY: \_\_\_\_\_

DATE: \_\_\_\_\_

RoHS COMPLIANT

PRELIMINARY

DIMENSIONS IS BRACKETS [ ] ARE METRIC

0A	JGK	8/29/19	DRAWING CREATED FOR PDR #18004.
REV.	INIT.	DATE	DESCRIPTION
			ORIG. DRAWN BY: JGK DATE: 8/29/19
<small>ALL INFORMATION ILLUSTRATED IS THE PROPERTY OF CONXALL CORPORATION. UNAUTHORIZED DUPLICATION OR DISTRIBUTION OF THIS DOCUMENT IS PROHIBITED.</small>			<p>601 E. WILDWOOD VILLA PARK, IL 60181</p>
<small>ALL UNITS ARE IN FEET, INCHES, FRACTION OF INCHES AND DECIMALS.</small>			
<small>UNLESS OTHERWISE SPECIFIED TOLERANCES: 3 PLACE DECIMALS ±.005 ANGLES ±1° FRACTIONS ±1/16</small>			TITLE: CABLE TO CABLE CONN. ASS'Y (5-7) #26 SOCKET CONTACTS, SOLDER INSTA-CLICK, MICRO-CON-X STANDARD PRODUCT
FILE:	W18982-XSG-P-5XX	DIRECTORY:	SLW
CUSTOMER: W18982-XSG-P-5XX		PART NUMBER:	W18982-XSG-P-5XX
			REV 0A

# Mouser Electronics

Authorized Distributor

Click to View Pricing, Inventory, Delivery & Lifecycle Information:

[Switchcraft:](#)

[W18982-6SG-P-522](#) [W18982-7SG-P-522](#) [W18982-5SG-P-522](#)