

Crimp 02 : Full crimp

COMPONENTS

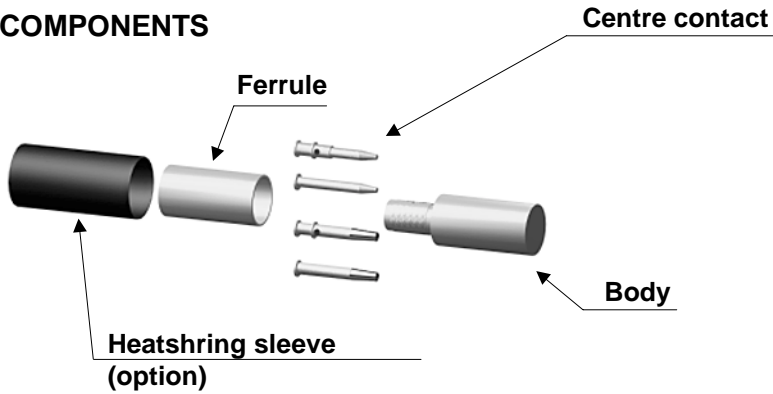

STRIPPING DIMENSIONS

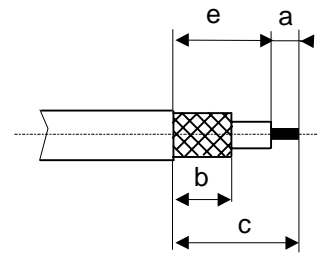

1

Slide the heatshrink sleeve onto the cable (Option).
Slide the ferrule onto the cable.
Strip the cable.

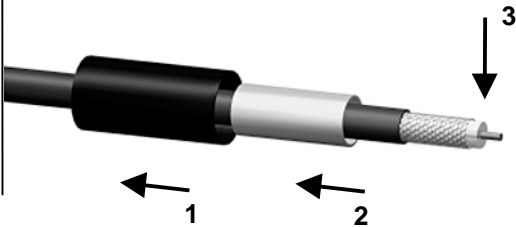

4

Slide the cable into the body until it bottoms against insulator.

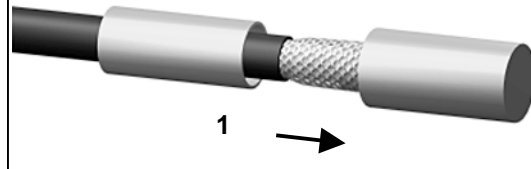

2

Slide the centre contact on until it bottoms against the cable dielectric.
Crimp the centre contact with crimping tool (see connector TDS).

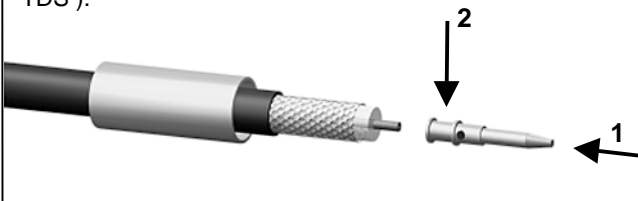

5

Slide the ferrule over the braid.
Crimp the ferrule with crimping tool (see connector TDS).

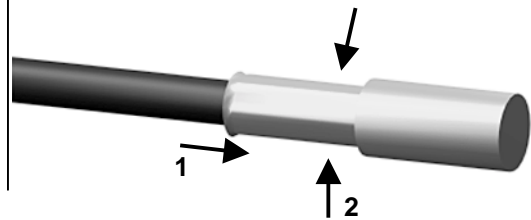

3

Fan the braid.

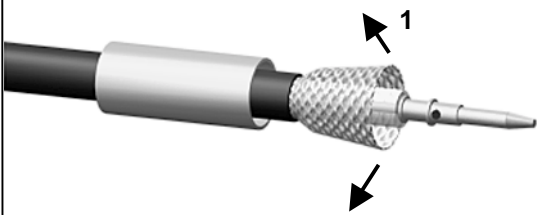

6

Cut the excess of braid if necessary.
Slide the sleeve over the ferrule and heatshrink it in place (Option).

