

SMD SHIELDED POWER INDUCTOR



18.5 x 15.2 x 7.6 mm

ASPI-1306S



RoHS
Compliant

FEATURES:

- Low radiation shielded architecture
- Large pads for good PCB mounting
- Low DCR, suitable for large currents
- High Energy storage

APPLICATIONS:

- Portable communication equipment
- OA equipment
- LCD, DVD, modem, set-top box
- DC/ DC converter

ELECTRICAL SPECIFICATIONS:

Abracon P/N:	ASPI-1306S
Operating Temperature:	-40°C to +125°C (including self-generated heat)
Storage Temperature:	-40°C to +125°C

PART NUMBER	INDUCTANCE (uH) ±20%	DCR(Ω) max	Isat (A) max	Irms (A) max
ASPI-1306S-100M	10	0.0400	8.00	3.90
ASPI-1306S-150M	15	0.0480	7.00	3.40
ASPI-1306S-220M	22	0.0590	6.00	3.10
ASPI-1306S-330M	33	0.0750	5.00	2.80
ASPI-1306S-470M	47	0.0970	4.00	2.40
ASPI-1306S-680M	68	0.1380	3.00	2.00
ASPI-1306S-101M	100	0.2070	2.40	1.70
ASPI-1306S-151M	150	0.2930	2.10	1.30
ASPI-1306S-221M	220	0.4700	1.90	1.10
ASPI-1306S-331M	330	0.7800	1.10	0.86
ASPI-1306S-471M	470	0.9750	0.90	0.60
ASPI-1306S-681M	680	1.4000	0.96	0.64
ASPI-1306S-102M	1000	2.0100	0.80	0.53

Test Conditions

Inductance: 100kHz, 0.1V

Isat: $\Delta L/L$ (initial) $\geq -10\%$

Irms: $\Delta T \leq 40^\circ\text{C}$

OPTIONS AND PART IDENTIFICATION

ASPI-1306S - [] [] - []

Inductance Code

Please refer to the table above

Tolerance %

M: $\pm 20\%$

Packaging

T: Tape and Reel
(250pcs / reel)

SMD SHIELDED POWER INDUCTOR



18.5 x 15.2 x 7.6 mm

ASPI-1306S



RoHS
Compliant

ELECTRICAL SPECIFICATION CHART

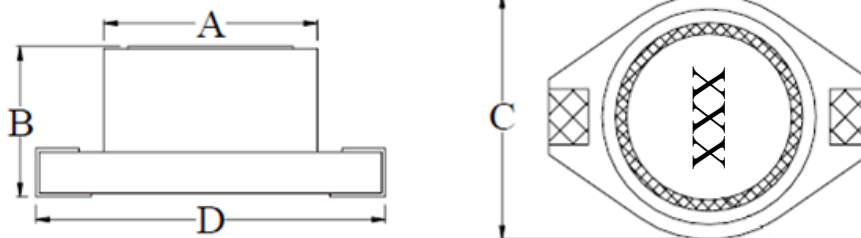

LAND PATTERNS

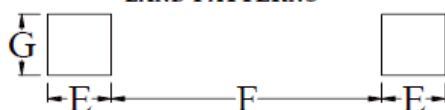

	DIM.	TOL.
A	12.7	±0.2
B	7.62	Max.
C	15.24	Max.
D	18.54	Max.
E	2.92	REF.
F	12.45	REF.
G	2.79	REF.

Materials

No	Part Name	Material
1	Core	Fe ₂ O ₃
		NiO
		CuO
		MgO
		ZnO
		MnO ₂
2	Enamelled Wire	Copper
		Modified Polyester Resin
3	Base	Copper
		Iron
		Zinc
		Tin
4	SN	COF
		Pure Tin Plating

Dimension: mm

SMD SHIELDED POWER INDUCTOR



18.5 x 15.2 x 7.6 mm

ASPI-1306S



ELECTRICAL SPECIFICATION CHART

Packing

T: 250pcs / reel

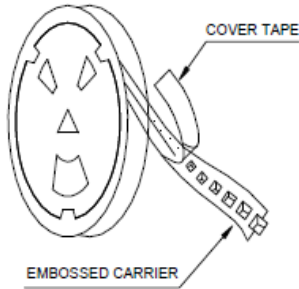

★The force for tearing off cover tape is 10 to 130 grams in the arrow direction under the following conditions.

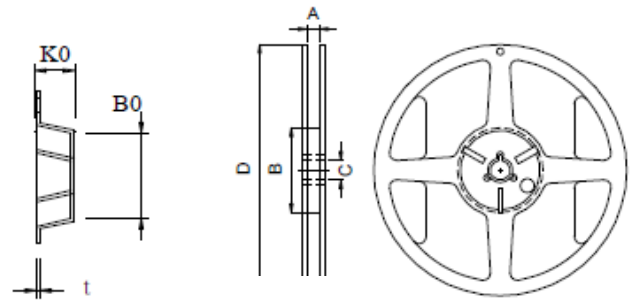
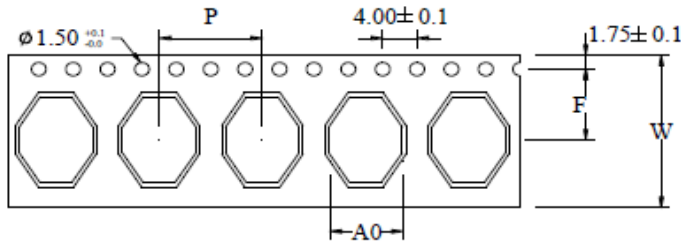
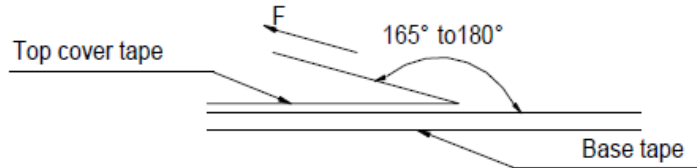

Carrier Tape / Size (mm)							Reel 13" x 32 mm			
A0	B0	K0	P	W	F	t	A	B	C	D
15.7 ± 0.1	19 ± 0.1	7.6 ± 0.1	20 ± 0.1	32 ± 0.3	14.2 ± 0.1	0.4 ± 0.05	32.5 ± 0.2	100 ± 0.5	13.2 ± 0.3	330 ± 1.0

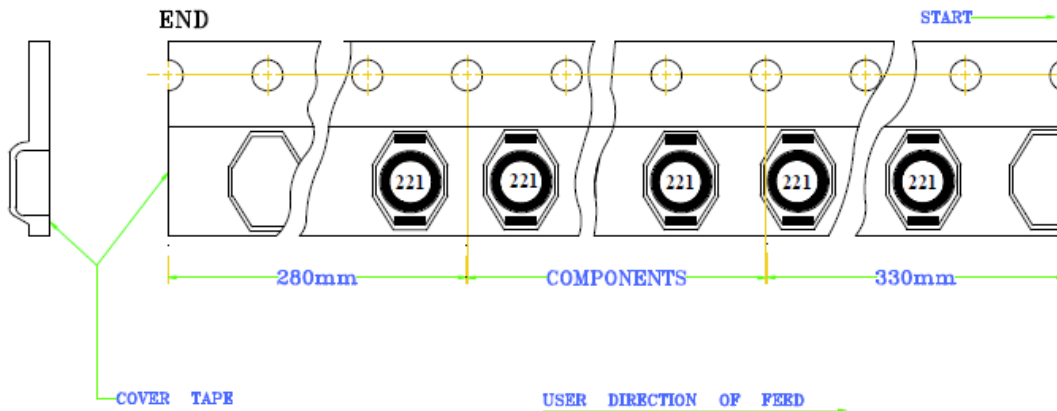

Dimension: mm

SMD SHIELDED POWER INDUCTOR



18.5 x 15.2 x 7.6 mm

ASPI-1306S



REFLOW PROFILE:

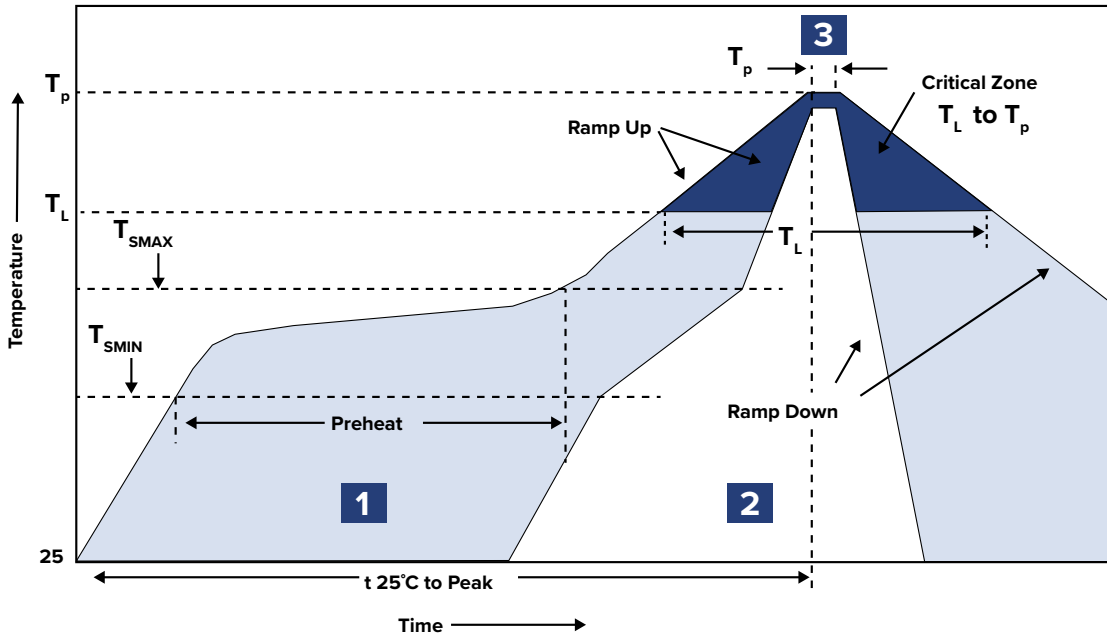

Zone	Description	Temperature	Time
1	Preheat / Soak	T_{SMAX} 120°C ~ 180°C	50 ~ 150 sec.
2	Reflow	T_L 217°C	90 sec.
3	Peak heat	T_P 245°C ~ 250°C	10 ~ 30 sec. MAX

ATTENTION: Abracon LLC's products are COTS – Commercial-Off-The-Shelf products; suitable for Commercial, Industrial and, where designated, Automotive Applications. Abracon's products are not specifically designed for Military, Aviation, Aerospace, Life-dependent Medical applications or any application requiring high reliability where component failure could result in loss of life and/or property. For applications requiring high reliability and/or presenting an extreme operating environment, written consent and authorization from Abracon LLC is required. Please contact Abracon LLC for more information.