

ULTRAVOLT HVA SERIES

PRECISION HIGH VOLTAGE AMPLIFIER

The UltraVolt® HVA series of DC-to-DC high voltage power supplies operates a precision filter/divider and linear HV switch to produce a high voltage amplifier (HVA). These modules provide a high-resolution, programmable, high voltage DC to full scale waveform capability greater than 1 kHz output. This is optimized for bias applications while providing excellent line regulation, load regulation, dynamic response, and stability. It can both source and sink current.

PRODUCT HIGHLIGHTS

- DC, reversible, and amplifier modes
- Fast slew rate (40 V/μs) and high bandwidth
- Can both source and sink current
- Bipolar models available at 0 to 5 kV
- Unipolar models available at 0 to 10 kV
- PPM level line and load regulation
- 50 ppm temperature coefficient (25 ppm optional)
- Available reduced ripple option
- Differential precision 0 to 10 VDC control input
- Precision output voltage and current monitors
- UL/cUL recognized component; CE Mark (LVD and RoHS)

TYPICAL APPLICATIONS

- Drivers
 - PZT actuators
 - MEMS devices
 - Electroactive polymers
 - Electrorheological materials
 - Electrohydrodynamics
 - Electrostatic chuck
 - Pockels cells
 - Laser and electro-optic modulation
 - Electrophoresis
- Amplifiers
 - Beam devices such as mass spectrometers and electron microscopes as electrostatic deflection/focusing, flocking, coating, electrospinning, precipitation, and electrocoalescence

ELECTRICAL SPECIFICATIONS

Parameter	Conditions	Models							Units
Input		All Types							
Voltage Range	Full Power	24 VDC ±10%							VDC
Current	Standby/Disable	< 70 unipolar, < 105 bipolar							mA
Current	Full Load, Max Eout	< 420							mA
Current	No Load, Max Eout	< 400							mA
Output ¹		1 kV/±1 kV	2 kV/±2 kV	4 kV/±4 kV	±5 kV	6 kV	10 kV		
Power	Nominal Input, Max Eout	0.25	0.5	1	1	1	1	W	
Current	Iout Entire Voltage Range	250	250	250	200	167	100	µA	
Ripple	Full Load, Max Eout	0.05	0.05	0.05	0.03	0.03	0.01	%V pp	
Ripple with -F Option	Full Load, Max Eout	0.0125	0.0125	0.0125	0.0075	0.0075	0.0025	%V pp	
Voltage Monitor	Normal Operating Conditions	0 to 10 ±0.5%							VDC
Current Monitor	Normal Operating Conditions	0 to 10 ±1%							VDC
Line Regulation	Vin Min to Vin Max, Max Eout	< 0.01							%
Load Regulation	No Load to Full Load, Max Eout	< 0.01							%
Programming and Controls		All Types							
Input Impedance	Normal Operating Conditions	10							MΩ
Adjust Voltage	Differential	0 to +10							VDC
HV ON/OFF (Enable/Disable)		0 to +0.8 V disable, +2.5 to +10 enable (default = disable)							VDC
Reference Voltage	T = +25°C, Initial Value	+10.00 ±0.05%							VDC
Max Source Current	T = +25°C	5							mA

Environmental		All Types							
Operating	Full Load, Max Eout, Case Temp.	+10 to +45							°C
Temperature Coefficient	Over the Specified Temperature	50 PPM or 25 PPM							PPM/°C
Thermal Shock	Mil-Std 810, Method 503.4-2	-40 to +65							°C
Storage	Non-Operating, Case Temp.	-40 to +100							°C
Humidity	All Conditions, Standard Package	0 to 95%, non-condensing							-
Altitude	Standard Package, All Conditions	Sea level through 10,000							ft
Shock	Mil-Std-810, Method 516, Proc. 4	20							Gs
Vibration	Mil-Std-810, Method 514, Fig. 514-3	10							Gs

¹ Units listed without polarity can be ordered as positive (+) or negative (-). Units listed as (±) are bipolar.

Contact AE for preset fixed outputs or other requirements.

ELECTRICAL SPECIFICATIONS (CONTINUED)

Sample HVA Series Waveforms

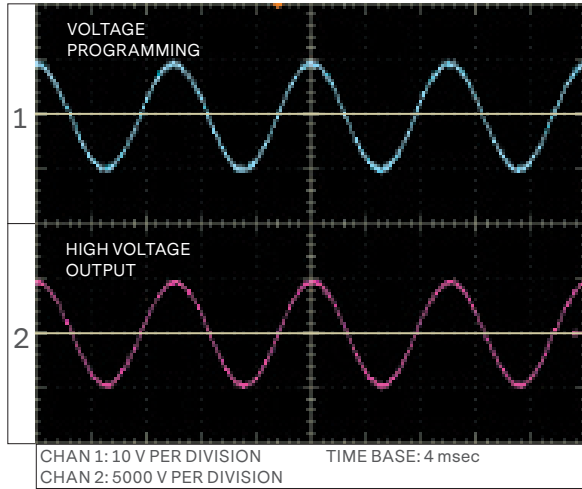

Figure A. 5HVA24-BP1 sine wave input

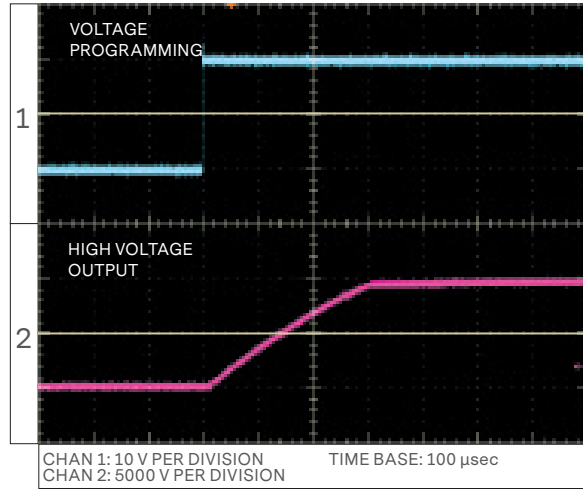

Figure B. 5HVA24-BP1 10 kV step wave input with no load

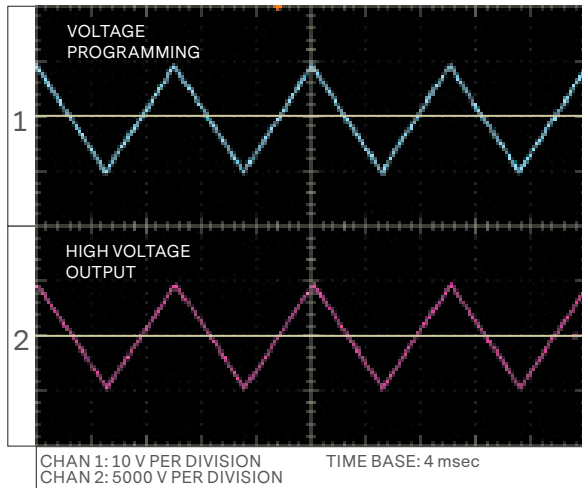

Figure C. 5HVA24-BP1 triangle wave input

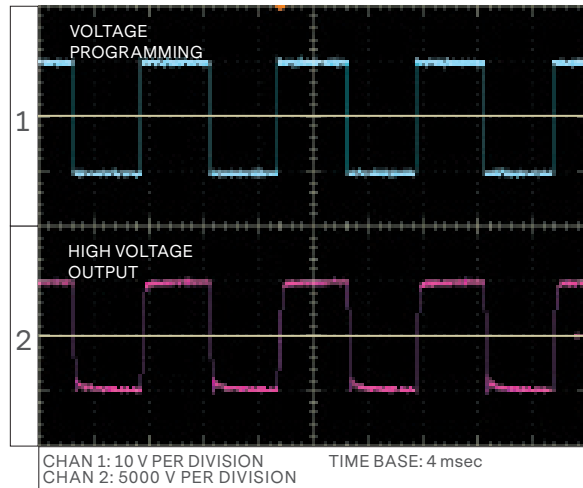

Figure D. 5HVA24-BP1 square wave input

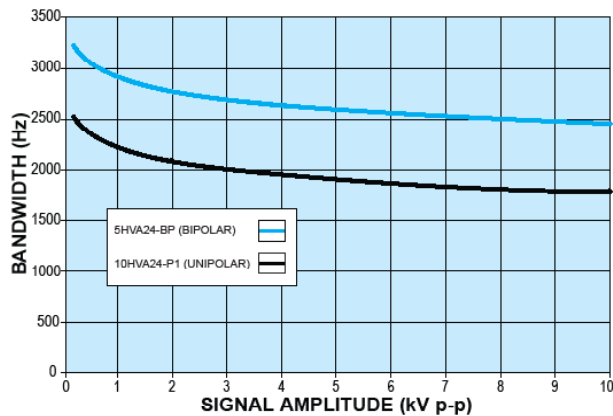

Figure E. Bandwidth vs. signal amplitude with no load

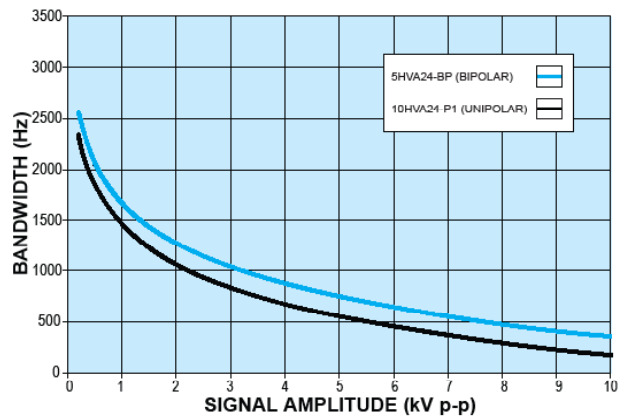
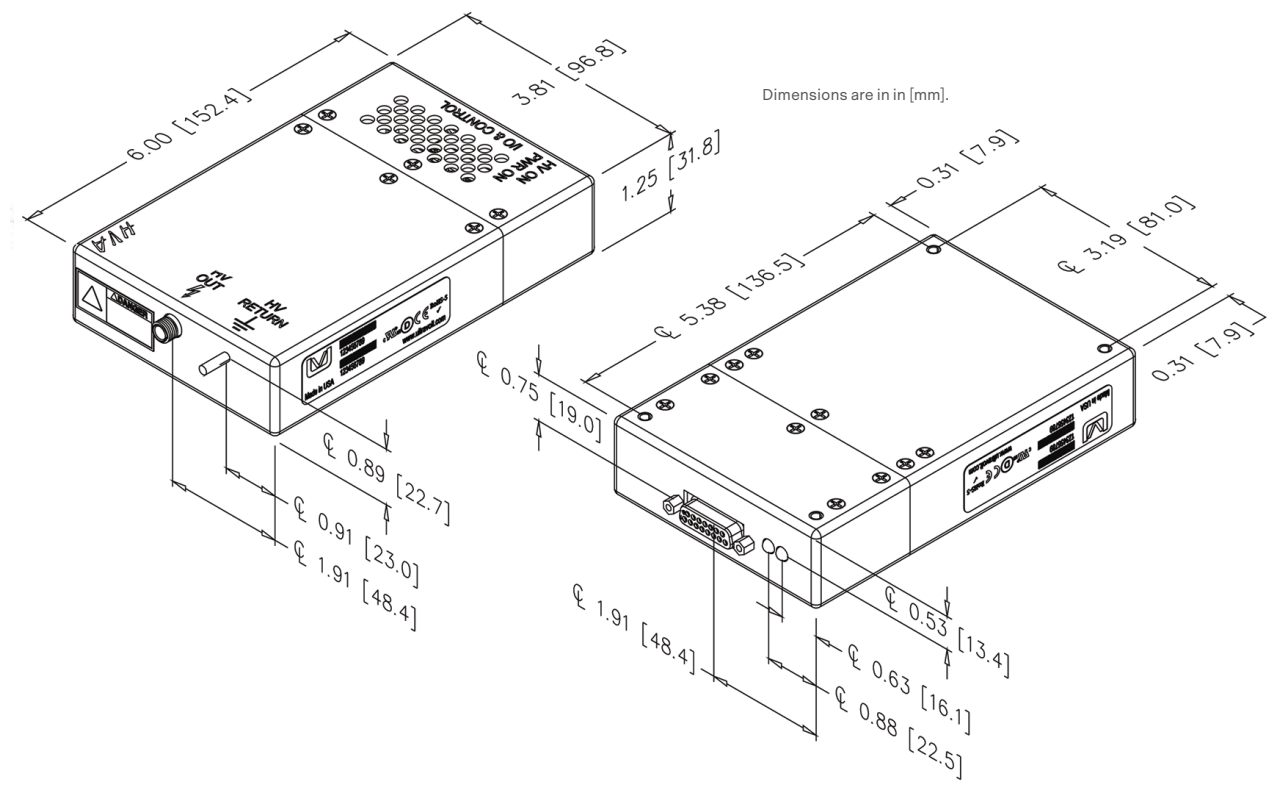

Figure F. Bandwidth vs. signal amplitude with 100 pF load

MECHANICAL SPECIFICATIONS



Dimensions	
Construction	Aluminum alloy 5052-H32 Anodize MIL-A-8625E blue

Volumes and Weights		
	cm ³	in ³
Volume	468.34	28.58
	kg	lb
Weight	0.68	1.5

INTERFACE

Connections	
Sub-miniature D	15-pin, female
HV Connector	LGH1/2L
HV Return	#6-32 x 0.437 long threaded post

UV-HVA Input Connector Pinout Functions		
Pin	Description	Function
1	Reference Voltage	+10.00 V precision reference
2	Voltage Programming -	0 to +10 V or 0 to -10 V to program full output voltage, depending on polarity. Programming input is differential between pins 2 and 3.
3	Voltage Programming +	
4	Voltage Monitor	0 to ±10 V represents 0 to ± full output voltage
5	N/C	No connection
6	Signal Ground	Reference all control signals here.
7	Input Power	+24 V input power
8	Input Power	
9	Power Ground	Input power return
10	Power Ground	
11	Enable	TTL high to enable, low to disable, default is OFF
12	Current Monitor	0 to ±10 V represents 0 to ± full output current
13	Current Limit Adjust	0 to +10 V sets current limit from 0 to full rated output current
14	N/C	No connection
15	Signal Ground	Reference all control signals here.

ULTRAVOLT HVA SERIES

ORDERING INFORMATION

Type	0 to 1000 VDC Output	1HVA
	0 to 2000 VDC Output	2HVA
	0 to 4000 VDC Output	4HVA
	0 to 5000 VDC Output (Bipolar Only)	5HVA
	0 to 6000 VDC Output (Unipolar Only)	6HVA
	0 to 10000 VDC Output (Unipolar Only)	10HVA
Input	24 VDC Nominal	24
Polarity	Positive Output	-P
	Negative Output	-N
	Bipolar Output	-BP
Power	1 W Output	1
Option	Ripple Stripper® Output Filter	-F
	25 PPM Temperature Coefficient	-25PPM
Connections	LGH	Standard
	5 kV SHV Type	-SHV-5kV
	10 kV, BNC Type	-BNC-10kV

Requires mating cable CA-17205-L4 to operate. (Sold Separately)





For international contact information,
visit advancedenergy.com.

powersales@aei.com (Sales Support)
productsupport.ep@aei.com (Technical Support)
+1 888 412 7832

ABOUT ADVANCED ENERGY

Since 1981, UltraVolt® — now part of the Advanced Energy (AE) family — has perfected how power performs for its customers. For both end users and OEMs, AE's comprehensive portfolio of standard and custom high voltage components precisely match system specifications to deliver unparalleled energy, quality, and performance. Through close customer collaboration, design expertise, application insight, and world-class support, AE creates successful partnerships and enables customers to push the boundaries of innovation and stay ahead of evolving market needs.

PRECISION | POWER | PERFORMANCE | TRUST



CAUTION:
High Voltage

Read and understand all documentation before you install, operate, or maintain Advanced Energy high voltage power supplies. Follow all safety instructions and precautions to protect against property damage and serious or possibly fatal bodily injury. Never defeat safety interlocks or grounds.

Specifications are subject to change without notice. Not responsible for errors or omissions. ©2022 Advanced Energy Industries, Inc. All rights reserved. Advanced Energy®, AE®, and UltraVolt® are U.S. trademarks of Advanced Energy Industries, Inc.



Mouser Electronics

Authorized Distributor

Click to View Pricing, Inventory, Delivery & Lifecycle Information:

Advanced Energy:

[2HVA24-BP1-F-25PPM-SHV-5KV](#) [5HVA24-BP1-F-25PPM-SHV-5KV](#) [10HVA24-P1-25PPM](#) [2HVA24-N1-25PPM](#)
[2HVA24-N1-F-25PPM](#) [4HVA24-N1-SHV-5KV](#) [6HVA24-P1-F-5PPM-BNC-10KV](#) [10HVA24-N1-BNC-10KV](#) [5HVA24-](#)
[BP1-F-25PPM](#)