

COPAL ELECTRONICS

DISPLAY TYPE PRESSURE SWITCH

PS30

CE marking
(Compliance with EMC Standards)

INSTRUCTION MANUAL Ver.2.1a

Thank you for purchasing a
NIDEC COPAL ELECTRONICS CORP. product.
For proper and optimal use of the product, please read
this manual thoroughly before using.
Keep this manual for future reference.

For more detailed information please ask for the nearest
distributor or the following sales center.

COPAL ELECTRONICS

Nishi-Shinjuku Kimuraya Bldg., 7-5-25
Nishi-Shinjuku, Shinjuku-ku, Tokyo 160-0023 Japan Phone: (03) 3364-7055

⚠ Important Information and Warnings

- ① Non-corrosive gases should be used as pressure media for PS30.
- ② The maximum applicable pressure for the PS30-102R at the time of vacuum break is 500kPa.
- ③ Always carry out wiring work with the power off.
- ④ For stability, use a regulated direct current power supply.
Surge absorbing devices (diodes, varistors, etc.) are necessary if inductive loads such as relays and solenoids are connected to the same power line as the PS30. Do not wire in parallel to high voltage cables or power lines, or use the same cable ducts which contain high voltage cables or power lines.
- ⑤ Check fluctuations in power voltage so that the power input cannot exceed the rating.
- ⑥ Be careful not to apply force to any wires during handling, or apply force to the display area of the main body during piping.
- ⑦ Use pH neutral detergents to clean the body. Do not use lacquer thinner and other solvents for cleaning.
- ⑧ Do not use pointed objects such as pens to press the setting buttons on the display panel. Doing so may damage the setting buttons by piercing them.
- ⑨ Do not put a piece of wire or other long thin object from pressure port. Doing so may damage the internal diaphragm to cause malfunctioning.
- ⑩ Do not use the product in a place where much steams and/or dust exist or the product may be subjected to direct water or oil splash.
- ⑪ [Recommended measures against noise interference]
It is recommended to use noise absorbing components (line filter, surge absorber, etc.) in the power supply terminal of the PS30.

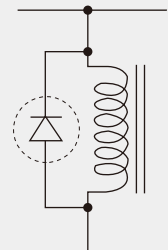

Surge absorbing circuit

Specifications

Model	PS30	
	102R	103R
Type (Pressure reference)	Gauge pressure	
Rated pressure range	-100~100kPa	-0.1~1.0MPa
Maximum pressure	200kPa	1.5MPa
Break-down pressure	500kPa	2.0MPa
Acceptable media	Non-corrosive gases	
Power supply	12V~24VDC±10%, ripple P-P 10% or less	
Current consumption	40mA maximum	
Switch outputs	Two outputs: NPN/PNP Transistor, open collector Switch rating: 30VDC, 100mA maximum Residual voltage: 1.2V maximum(NPN) / 2.2V maximum(PNP) at 100mA	
	Hysteresis	0~30 count setting (adjustable)
	Repeatability	±0.3%F.S.
	Response	5ms maximum
	Short circuit protection	Included
Pressure indication	Signed 2 1/2 digit, 7-segment-LED indication (sampling cycle: approx. 4 times per second)	
	Accuracy	±1%FS±1 digit
Switch status indication	Output 1 (SW1) and output 2 (SW2), LED (red) light up when switch outputs are ON.	
Operating conditions	IP protection	Meets IP40 of IEC
	Operating temperature	-10~50°C (storage -20~70°C)
	Operating humidity	35~85 %RH
	Vibration resistance	10~500Hz, amplitude 1.5mm/98.1m/S ² , three directions, two hours each
	Shock resistance	490m/S ² , three directions, three times each
	EMC	EMI: EN55011 1998 class B (Group1) EMS: EN61326-1:1997/A-1:1998/The permissible variations in display counts and set value of switch output not exceed±5%FS.
Thermal error	±3%FS (0~50°C, reference temp. 25°C)	
Pressure port	M5 female screw, O-ring groove (P8)	
Pressure receiving area material	Single crystal silicon	
Net weight	Approx. 60g (included 1.5m cable)	

Output Electrical Diagram (Wire colors correspond to I.E.C standards)

NPN Open Collector Output Model

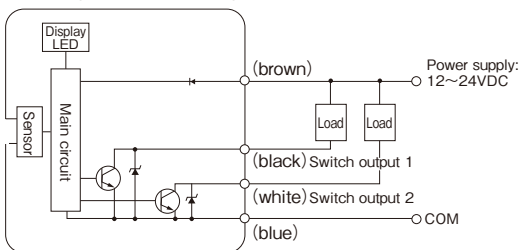

PNP Open Collector Output Model

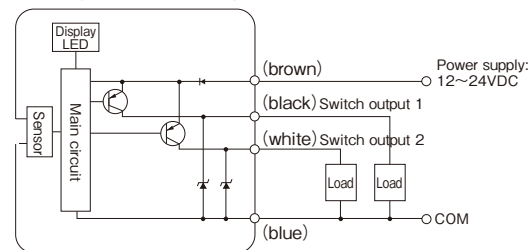

Wire color	Connection
Brown	Power ⊕
Blue	Common
Black	SW Output1
White	SW Output2

Details of the front panel

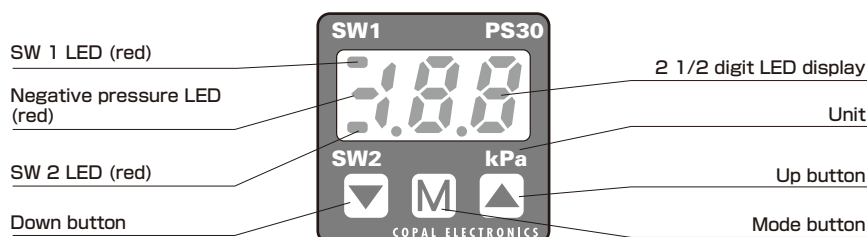

Error Messages

■ If the following error messages are displayed, follow the procedures in the table:

Error message	Problem	Solution
	Overload current. (Brinking of SW1 or SW2 indicates excessive current on SW1 or SW2.)	Disconnect the power, then check the load condition.
	Pressure detected when adjusting the zero point.	Press the [M] button and reset the display. Release the applied pressure in the pressure port (opened to the atmosphere) and adjust the zero point again.
	Examination by Nidec Copal Electronics is required.	Telephone the nearest office or Sensor Department of Nidec Copal Electronics Corp.
	Pressure value exceeds 110% of the rating. (This error examples when the pressure more than 111kpa is applied to the 102R mode.)	Check the applied pressure.
	Applied pressure is higher than the maximum value of the pressure display range.	Check the applied pressure.
	Applied pressure is higher than the maximum value of the pressure display range.	Check the applied pressure.

(Note 1) No error messages will be shown when non-display mode is selected.

(Note 2) When the applied pressure exceeds 110% of rated pressure, the display indicate “flashing” or “-L-” or “-H-”. This displayed value is not accurate value, please use within the rated pressure range.

Functions

Non-display mode

● When you do not operate any buttons for about 10 seconds, the system will automatically select non-display mode and the LED indicator section will go off. Pressing any key will cause the LED indicator section to come on back again.

(Note 1) The decimal point shown in the figure on the right blinks during non-display mode.

(Note 2) Switch outputs and switch LEDs are operable even during non-display mode.

(Note 3) No error messages will appear during non-display mode.

※ For how to select non-display mode, see the description of the initial setting mode.

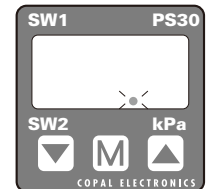

Conversion factor

● You can select a conversion factor from the options shown in the table on the right.
(Note 1) Slashed box: No factors options are available due to inappropriate resolution and the number of digits for display.

※ For how to set the conversion factor, see the description of the initial setting mode.

Number selected	Pressure range			
	102R		103R	
	Factor	Display range	Factor	Display range
0	×1	-100~100	/	/
1	/	/	×1	-0.10~1.00
2	×0.75	-75~75	/	/
3	×0.01	-1.00~1.00	×10	-1.0~10.0
4	×0.145	-14.5~14.5	×145	-14~145

Switch working mode

● You can select switch working mode from the options shown in the table below.

(Note 1) In the Separate Mode, SW1 and SW2 work separately.

(Note 2) In the Window Comparator Mode, the minimum value for SW1 and SW2 corresponds to Setting 1 and the maximum value to Setting 2.

※ For how to set the switch output, see the description of the initial setting mode.

Number selected	Output	SW1				SW2			
	Mode	Separate		Window Comparator		Separate		Window Comparator	
	Operation	H	L	A	B	H	L	A	B
0		○				○			
1		○					○		
2			○				○		
3						○			
4				○				○	
5				○				○	
6					○				○
7									○
		Setting 1		Minimum: Setting 1 Maximum: Setting 2		Setting 2		Minimum: Setting 1 Maximum: Setting 2	
		Note 1	Note 2	Note 1	Note 2	Note 1	Note 2	Note 1	Note 2

There are four operation modes. There are shown in the diagrams below.

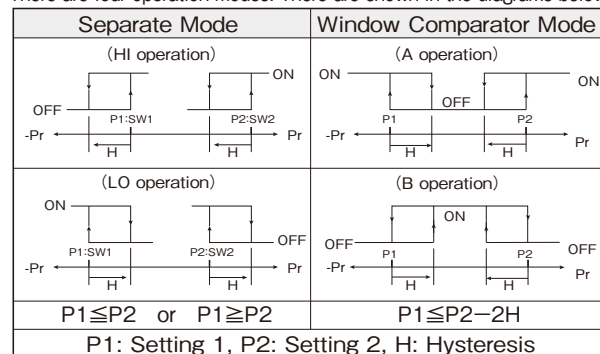

Digital filter

● Two different digital filters (25ms and 250ms) are available.

The digital filters are useful when it is hard to take readings due to too great fluctuations in pressure.

(Note 1) Any selected digital filter will be reflected on the pressure display and switch action.

※ For how to set the digital filter, see the description of the pressure setting mode.

Operational Procedures

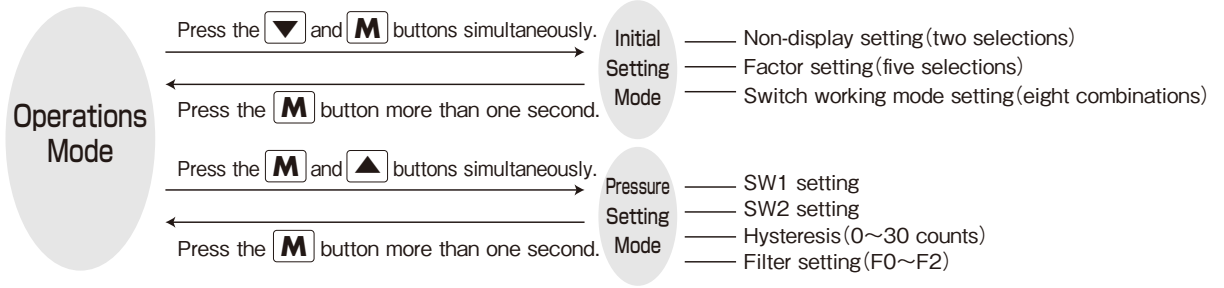

Initial Setting Mode

This mode is used to set non-display mode, magnification and switch outputs.

Entering Initial Setting Mode

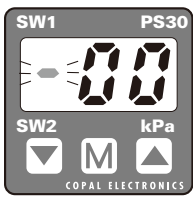

Press the **SW2** and **M** buttons simultaneously in Operations Mode. After switched to Initial Setting Mode, the third digit will blink. (The values **-00** for the 102R model and **-10** for the 103R have been set in the factory.)

Making initial setting

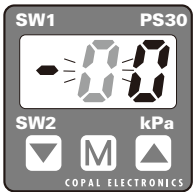

Press the **M** button to move to the next digit. The value of the digit may be set when the LED below the digit blinks. The number will change every time the **SW2** or **SW1** button is pressed. Press the **M** button to move to the next digit.

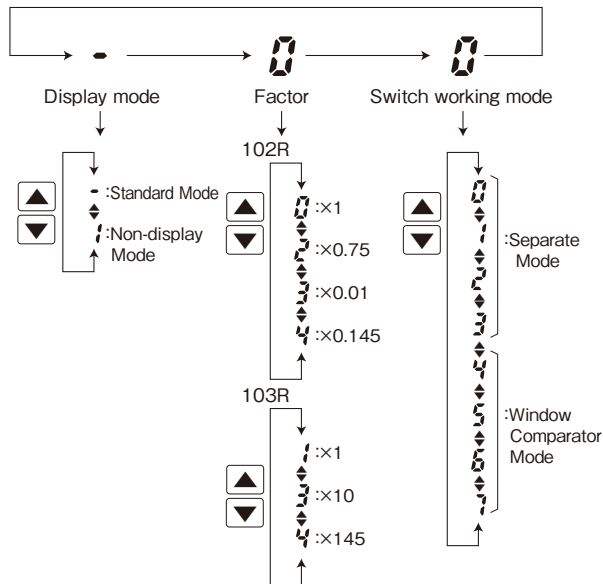

Exiting Initial Setting Mode

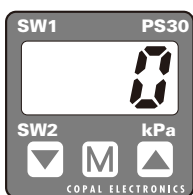

Press the **M** button more than one second. The initial settings will be set and you will return to Operations Mode.

Pressure Setting Mode

This mode is used to make Setting 1, Setting 2, hysteresis and digital filter setting.

Entering Pressure Setting Mode

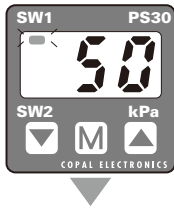

Press the **M** and **▲** buttons simultaneously in Operations Mode.
 After switched to Pressure Setting Mode, SW1 should be blinking to indicate the value for Setting 1.
 (The values **50** for 102R and **50** for 103R have been set in the factory.)

Setting pressure value

Setting 1 (P1)

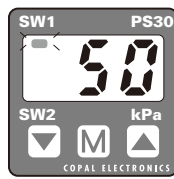

Press the **M** button.

The SW1 LED should be blinking.
 Use the **▼** or **▲** button to select a value for Setting 1 (P1).
 (The values **50** for 102R and **50** for 103R have been set in the factory.)
 (Note 1) The setting can only be made within the allowable display range.
 (Note 2) The setting should meet $P1 \leq P2 - 2H$ when Window Comparator Mode is selected.

Setting 2 (P2)

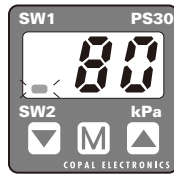

Press the **M** button.

The SW2 LED should be blinking.
 Use the **▼** or **▲** button to select a value for Setting 2 (P2).
 (The values **50** for 102R and **50** for 103R have been set in the factory.)
 (Note 1) The setting can only be made within the allowable display range.
 (Note 2) The setting should meet $P1 \leq P2 - 2H$ when Window Comparator Mode is selected.

Hysteresis (H) setting

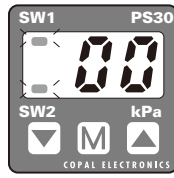

Press the **M** button.

The SW1 and SW2 LEDs should be blinking.
 Use the **▼** or **▲** button to set the hysteresis (H).
 (The values **00** for 102R and **00** for 103R have been set in the factory.)
 (Note 1) The setting should be 30 digits or less.
 (Note 2) The setting should meet $P1 \leq P2 - 2H$ when Window Comparator Mode is selected.

Digital filter setting

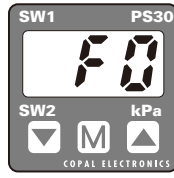

Press the **M** button.

Use the **▼** or **▲** button to set the digital filter.
F0: No filter, **F1**: 25ms filter, **F2**: 250ms filter
 (The value **F0** has been set in the factory.)

Exiting Pressure Setting Mode

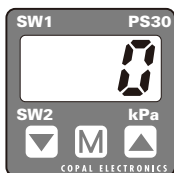

Press the **M** button more than one second.
 The pressure setting will then take effect and you will return to Operations Mode.

Zero Point Adjustment

Adjust the pressure indication at the time of pressure release in the pressure port to "zero".

Adjusting zero point

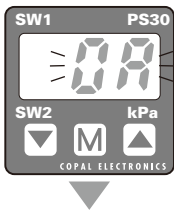

Release the applied pressure in the pressure port (i.e., let the pressure port be opened to the atmosphere). Press the and buttons simultaneously in Operations Mode. The value will blink when you enter the zero point adjustment phase.

Exiting zero point adjustment

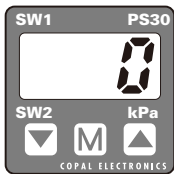

With the value flashing, release and buttons simultaneously. One second later zero point adjustment will be made and you will return to Operations Mode.

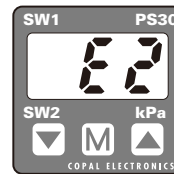

If pressure is applied during zero point adjustment, will be displayed. Press the button more than one second to reset the display. Release the applied pressure on the pressure port (opened to the atmosphere), then perform zero point adjustment again.

Piping and Installation

Piping

Hold the base section of the main body to connect a commercially available fitting (M5 male screw) to the main body. Tighten with a torque of 1.0 N·m or less. (Note) Do not apply any force on the cover section of the main body during tightening. The switch unit may break.

Back mounting screws

The main body can be secured to the panel by using the mounting screw holes located on the back (2-M3, effective depth: 6mm). To install, hold the unit on the base section when tightening the screws. Use a tightening torque of 0.3 N·m or less. (Note) Do not apply any force on the cover section of the main body during tightening. The switch unit may break.

Port Block (sold separately)

If using the port block (sold separately), put the O-ring (P8) in the O-ring groove located on the back of the main body as shown in the figure below, and install the port block by two M3×10 male screws. When installing, hold the base section of the main body, then tighten the male screws. Use a tightening torque of 0.3 N·m or less.

When connect a fitting to the port block, wind sealing tape around the pipe to prevent air leakage. The other pressure port which are not to be used should be stopped up with the sealing screw provided. In this case, wind sealing tape around the screws before using. Any firstly tighten the screws using fingers to avoid damage to the screw threads. Finally, tighten firmly with a wrench. (Recommended torque: 3.0 N·m) For piping work, secure the port block using a 12mm wrench. Use a tightening torque of 10.0 N·m or less. (Note) Do not apply any force to the cover section of the main body during tightening. The switch unit may break.

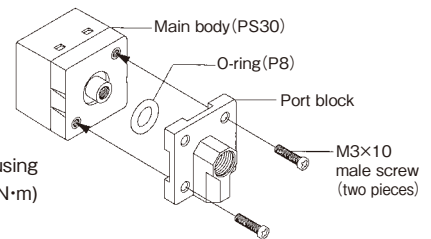

Angled Brackets (Option)

If using the angled bracket for wall attachment (sold separately) or the angle bracket for floor attachment (sold separately), install the angled bracket by two M3×4 male screws as shown in the figure below.

If using the angled bracket and the port block, install both the angled bracket and the port block by two M3×10 male screws. When installing, hold the base section of the main body, then tighten the male screws. Use a tightening torque of 0.3 N·m or less. (Note) Do not apply any force to the cover section of the main body during tightening. The switch unit may break.

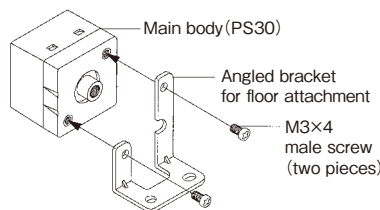
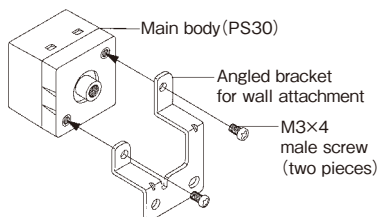

Panel Holder Set (Option)

If using the panel holder set (sold separately), install the main body to the panel folder, and hold the main body by two panel stopper through the attachment panel.

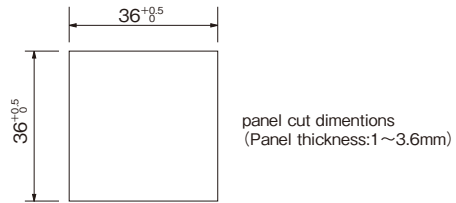
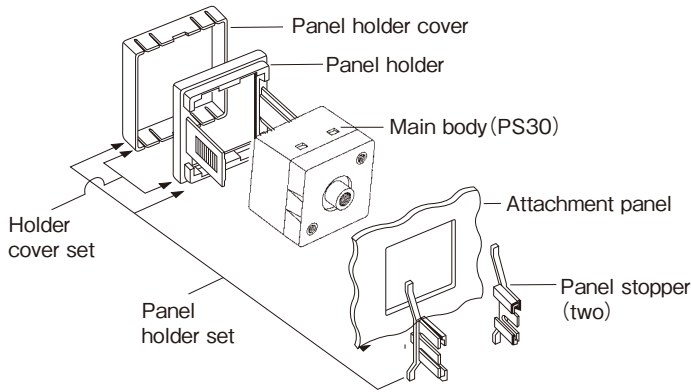

Accessories (Sold separately)

Product name	Model no.	Description	Applicable model
Angled bracket for wall attachment	ACPG-001	Angled bracket for wall attachment, two M3×4 male screws	PG-30 / PS30
Angled bracket for floor attachment	ACPG-002	Angled bracket for floor attachment, two M3×4 male screws	PG-30 / PS30
Panel holder set	ACPG-003	Panel holder cover, panel holder, two panel stoppers	PG-30 / PG-35 / PS30
Holder cover set (for protection of gauge sides)	ACPG-004	Panel holder cover, panel holder	PG-30 / PG-35 / PS30
Port block set	ACPG-005	Port block O-ring (P8) M3×10 male screw (two pieces) Sealing screw	PS30

Outline Dimensions (Unit: mm)

PS30

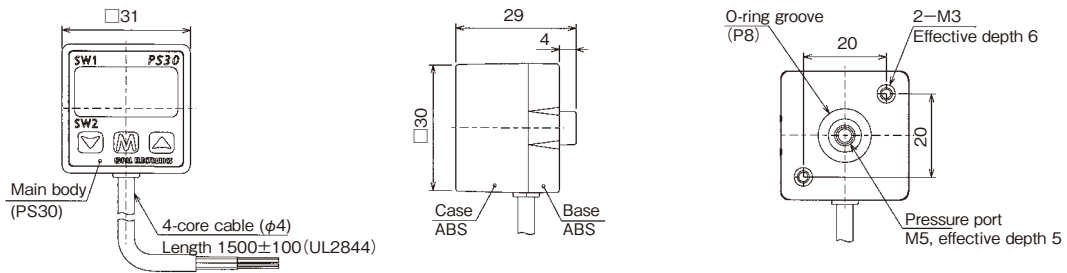

Port Block (sold separately)

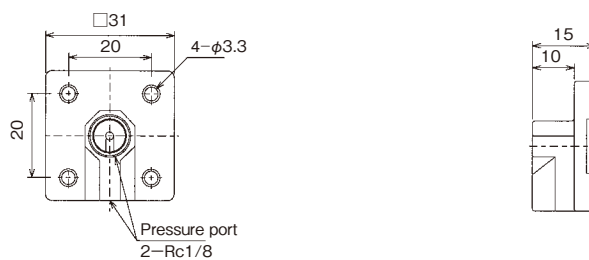

Angled Brackets(sold separately)

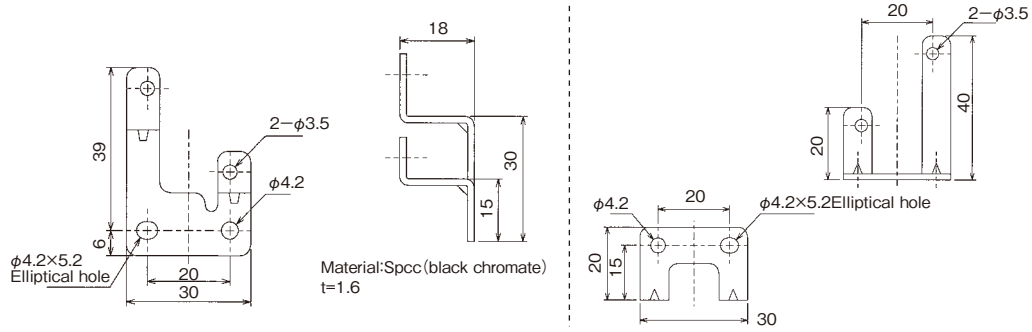

Panel holder set · Holder cover(sold separately)

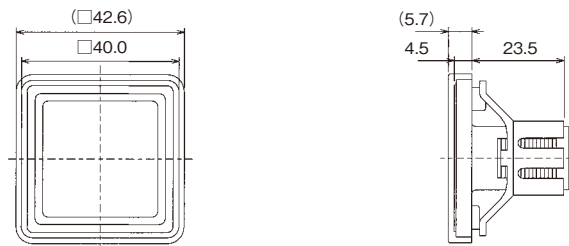

Warranty

This product can be covered by one-year warranty. COPAL ELECTRONICS warrants that any part of the product which proves to be defective due to the design and/or manufacturing of COPAL ELECTRONICS within one year from the date of delivery will be repaired or replaced, free of charge. Note that the warranty will only be applied to the product alone, not to damages induced by any failure of the product.

The warranty will not be applied in any of the following cases:

- ① Failure and damage caused by improper use not conforming to the instruction manual or negligent handling.
- ② Failure and damage caused by inappropriate modification, adjustment or repair.
- ③ Failure and damage caused by natural disaster, fire or other act of God.

Model Numbers

PS30 - 102 R - N

Pressure range

102: -100~100kPa
103: -0.1MPa~1.00MPa

Switch output type

N: NPN open collector
P: PNP open collector

Mouser Electronics

Authorized Distributor

Click to View Pricing, Inventory, Delivery & Lifecycle Information:

[Nidec:](#)

[ACPG-003](#) [ACPG-004](#) [ACPG-001](#) [ACPG-002](#)