

RDER72E224K3K1H03B



Applications

Unsuitable Applications	Please be sure to read and comply with these "Precautions for use."
Specific Applications	Consumer equipment, Industrial Equipment, Mobile Electronics, Medical equipment [GHF A/B/C] except for implant equipment, Automotive infotainment/comfort equipment Please refer to Our Website and specifications, etc. for information about the performance, functions, quality, management, and safety required for the above applications, and use Products after confirming the performance and reliability of the actual Product.

Notices

HF(Halogen Free)

Appearance & Shape

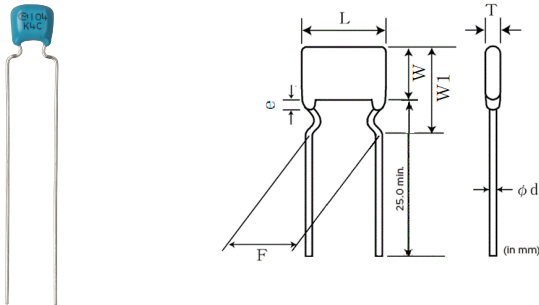

References

Packaging	Specifications	Standard Packing Quantity
B	Bulk(Bag)	500

Mass (typ.)	
1 piece	0.23g

Attention
 1.This datasheet is downloaded from the website of Murata Manufacturing Co., Ltd. Therefore, it's specifications are subject to change or our products in it may be discontinued without advance notice. Please check with our sales representatives or product engineers before ordering.
 2.This datasheet has only typical specifications because there is no space for detailed specifications.
 Therefore, please review our product specifications or consult the approval sheet for product specifications before ordering.

RDER72E224K3K1H03B

Specifications

L size or Outer diameter D	5.5mm max.
Width	5.0mm max.
T size	4.0mm max.
Lead spacing F	5.0±0.8mm
Lead diameter d	0.5±0.05mm
Paint dripping e	Up to the end of crimp
Capacitance	0.22μF ±10%
Rated voltage	250Vdc
Temperature characteristics	X7R(EIA)
Capacitance change rate	±15%
Temperature range of temperature characteristics	-55°C to 125°C
Operating Temperature Range	-55°C to 125°C
W1 size	7.5mm max.

Attention

1.This datasheet is downloaded from the website of Murata Manufacturing Co., Ltd. Therefore, it's specifications are subject to change or our products in it may be discontinued without advance notice. Please check with our sales representatives or product engineers before ordering.

2.This datasheet has only typical specifications because there is no space for detailed specifications.

Therefore, please review our product specifications or consult the approval sheet for product specifications before ordering.

RDER72E224K3K1H03B



Characteristic Data

The charts below may show another part number which shares its characteristics.

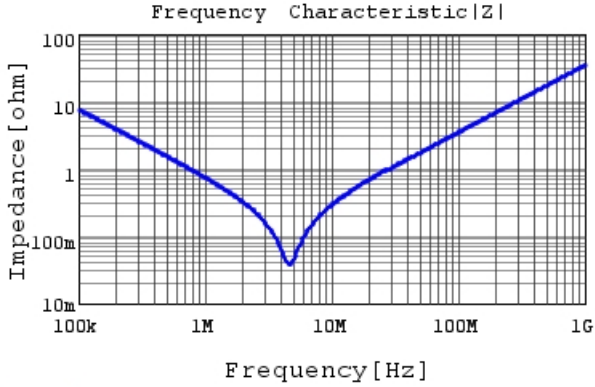

RDER72E224K3K1H03B |Z| DCOV, 25degC

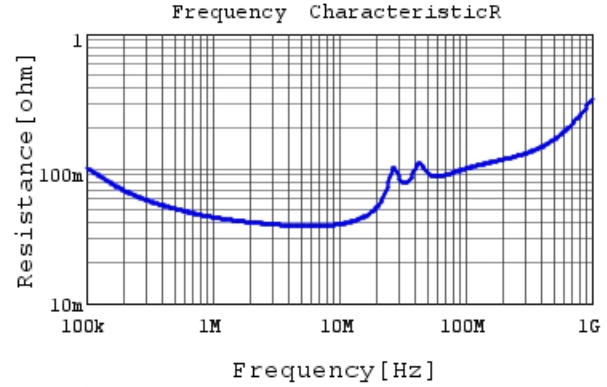

RDER72E224K3K1H03B R DCOV, 25degC

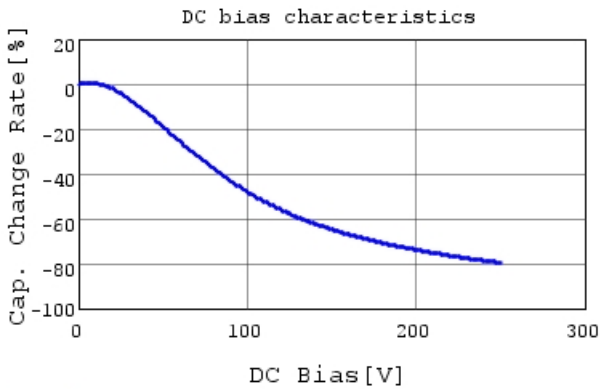

RDER72E224K3K1H03B C-DC bias capchange, 25.0

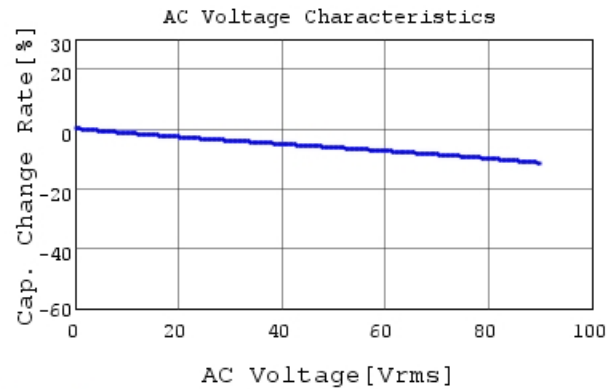

RDER72E224K3K1H03B C-AC Voltage capchange, I

Attention

- 1.This datasheet is downloaded from the website of Murata Manufacturing Co., Ltd. Therefore, it's specifications are subject to change or our products in it may be discontinued without advance notice. Please check with our sales representatives or product engineers before ordering.
- 2.This datasheet has only typical specifications because there is no space for detailed specifications. Therefore, please review our product specifications or consult the approval sheet for product specifications before ordering.

RDER72E224K3K1H03B

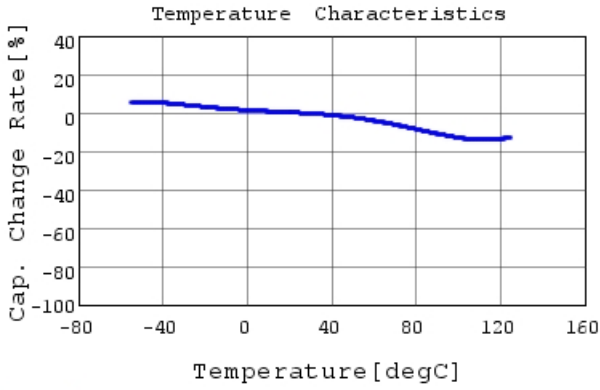

RDER72E224K3K1H03B C-Temp. capchange, DCOV,

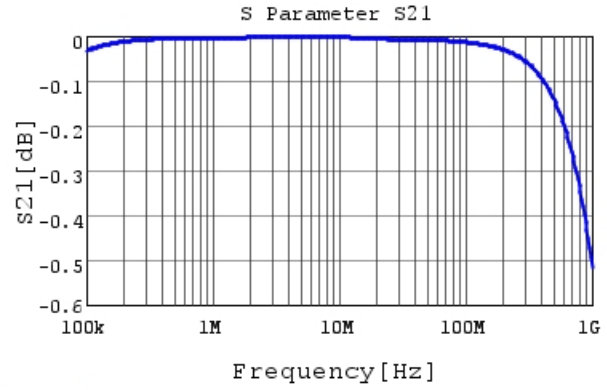

RDER72E224K3K1H03B S21 DCOV, 25degC

Attention

- 1.This datasheet is downloaded from the website of Murata Manufacturing Co., Ltd. Therefore, it's specifications are subject to change or our products in it may be discontinued without advance notice. Please check with our sales representatives or product engineers before ordering.
- 2.This datasheet has only typical specifications because there is no space for detailed specifications. Therefore, please review our product specifications or consult the approval sheet for product specifications before ordering.