

NOTES:

1. ALL PARTS TO BE BULK PACKED.
2. CONTACTS SUPPLIED UNASSEMBLED
3. ALL DIMENSIONS ARE REFERENCE ONLY EXCEPT THOSE WITH A TOLERANCE
4. DIMENSIONS IN BRACKETS [] ARE IN MILLIMETERS

ASS'Y P/N	GROMMET SIZE
W6380-XSG-P-513	.148 GROMMET I.D. FOR CABLE O.D. 0.13 - 0.15 [3.3 - 3.8]
W6380-XSG-P-516	.176 GROMMET I.D. FOR CABLE O.D. 0.16 - 0.18 [4.1 - 4.6]
W6380-XSG-P-519	.206 GROMMET I.D. FOR CABLE O.D. 0.19 - 0.21 [4.8 - 5.3]
W6380-XSG-P-522	.245 GROMMET I.D. FOR CABLE O.D. 0.22 - 0.25 [5.6 - 6.3]
(B) W6380-XSG-P-526	.265 GROMMET I.D. FOR CABLE O.D. 0.25 - 0.27 [6.3 - 6.8]
W6380-XSG-P-528	.280 GROMMET I.D. FOR CABLE O.D. 0.26 - 0.28 [6.6 - 7.1]

ASSEMBLY P/N	CONTACTS
W6380-2SG-P-5XX	2 #16
W6380-3SG-P-5XX	3 #16
W6380-4SG-P-5XX	4 #16
W6380-5SG-P-5XX	5 #16
W6380-XSG-P-5XX	

GROMMET SIZE
NUMBER OF CONTACTS

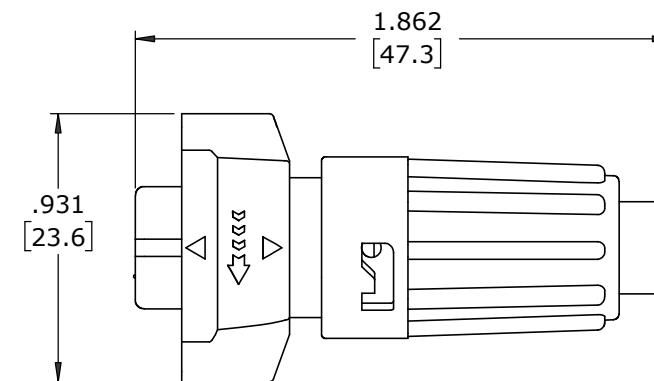
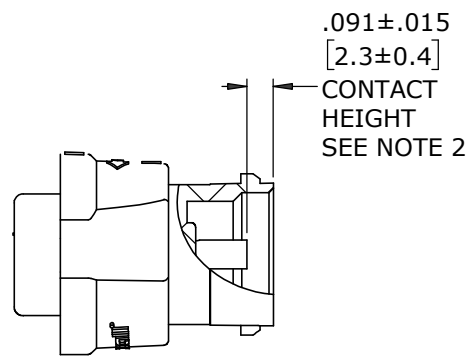

SHOWN ASSEMBLED
FOR CUSTOMER REFERENCE ONLY

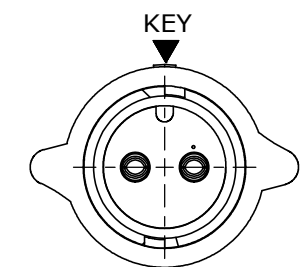

MATING FACE
W6380-2SG-P-5XX SHOWN

CABLE-END HOUSING
MAT'L: UV PBT, BLACK
COUPLING RING
MAT'L: UV PBT, BLACK
O-RING
MAT'L: SILICONE, RED
SPRING
MAT'L: STAINLESS STEEL

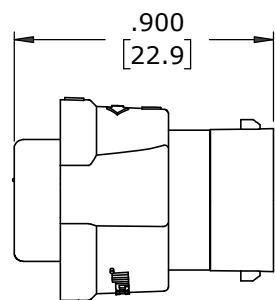

(2-5) #16 SOCKET CONTACTS, CRIMP
MAT'L: COPPER ALLOY, GOLD PLATED

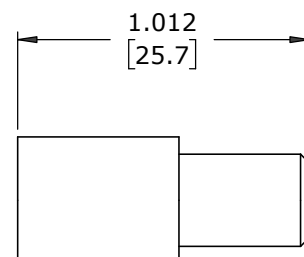
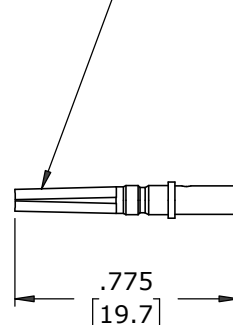

GROMMET
MAT'L: SANTOPRENE, BLACK

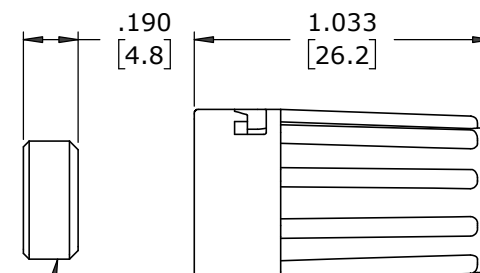

CABLE GRIP
MAT'L: POLYPROPYLENE, BLACK

BACKSHELL
MAT'L: UV PBT, BLACK

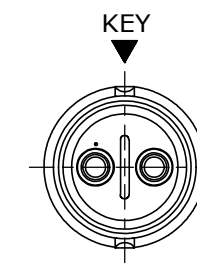

WIRING END
W6380-2SG-P-5XX SHOWN
WITHOUT HARDWARE

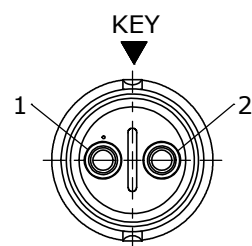

WIRING END
W6380-2SG-P-5XX

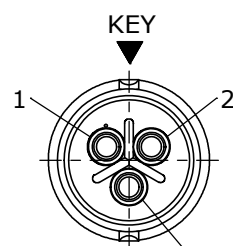

WIRING END
W6380-3SG-P-5XX

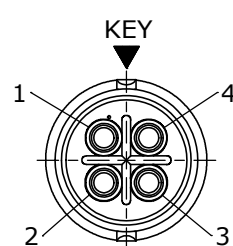

WIRING END
W6380-4SG-P-5XX

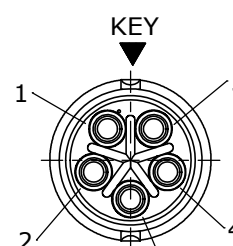

WIRING END
W6380-5SG-P-528

CUSTOMER APPROVAL

THIS DOCUMENT CONTAINS CONFIDENTIAL INFORMATION PROPRIETARY TO CONXALL CORPORATION. ANY REPRODUCTION, DISCLOSURE, OR USE OF THIS DOCUMENT /INFORMATION IS EXPRESSLY PROHIBITED UNLESS AUTHORIZED IN WRITING BY CONXALL CORPORATION.

APPROVED BY: _____
DATE: _____

RoHS COMPLIANT

B	MA	02-24-21	ADDED W6380-XSG-P-526 TO CHART PER ECR 9544
A	MA	03-02-20	RELEASED PER PDR 16014-7
	PNK	01-15-18	PDR 16014
REV.	INIT.	DATE	DESCRIPTION
			ALL INFORMATION ILLUSTRATED IS THE PROPERTY OF "CONXALL CORPORATION". UNAUTHORIZED DUPLICATION OR DISTRIBUTION OF THIS DOCUMENT IS PROHIBITED.
			ORIG. DRAWN BY: PNK DATE: 01-15-18
			CHECKED BY:
			APPROVED BY:
			ALL UNITS ARE IN FEET, INCHES, FRACTION OF INCHES AND DECIMALS.
			UNLESS OTHERWISE SPECIFIED TOLERANCES: 3 PLACE DECIMALS ±.010 ANGLES 5/16 FRACTIONS ±1/16
			SCALE SIZE SHEET NTS B 1 OF 1
			FILE: W6380-XSG-P-5XX DIRECTORY: SLW
			TITLE: CABLE-END ASSEMBLY 2-5 #16 SOCKET CONTACTS, CRIMP INSTA-CLICK™ MINI-CON-X STANDARD PRODUCT
			CUSTOMER: STANDARD PRODUCT
			PART NUMBER: W6380-XSG-P-5XX
			REV B



601 E. WILDWOOD VILLA PARK, IL 60181

Mouser Electronics

Authorized Distributor

Click to View Pricing, Inventory, Delivery & Lifecycle Information:

Switchcraft:

[W6380-2SG-P-522](#) [W6380-2SG-P-513](#) [W6380-4SG-P-519](#) [W6380-5SG-P-528](#) [W6380-3SG-P-516](#) [W6380-3SG-P-513](#) [W6380-4SG-P-516](#) [W6380-3SG-P-522](#) [W6380-4SG-P-526](#) [W6380-5SG-P-526](#) [W6380-2SG-P-528](#) [W6380-2SG-P-516](#) [W6380-2SG-P-519](#) [W6380-3SG-P-519](#) [W6380-5SG-P-516](#) [W6380-4SG-P-513](#) [W6380-3SG-P-528](#) [W6380-4SG-P-522](#) [W6380-5SG-P-519](#) [W6380-5SG-P-513](#) [W6380-4SG-P-528](#) [W6380-3SG-P-526](#) [W6380-5SG-P-522](#) [W6380-2SG-P-526](#)