

ORCY-60U12CG

Isolated DC-DC Converter

The ORCY-60U12CG is an isolated DC/DC converter that operates from a wide input range (18 - 75 VDC) and can cover both 24 Vin and 48 Vin input range. This unit will provide up to 84 W of output power.

It is designed to be highly efficient and low cost. Features include remote on/off, over current protection, over voltage shut down, over temperature protection and under-voltage lockout.

This converter is provided in an industry standard 1/8th brick package.



Key Features & Benefits

- 18 - 75 VDC Input
- 12 VDC / 7 A Output
- Isolated
- Fixed Frequency (258 kHz)
- High Efficiency
- High Power Density
- Input Under/Over Voltage Lockout
- Output Voltage Trim
- Basic Isolation
- Output Over-Voltage Shutdown
- Low Cost
- Positive / Negative Remote Sense
- OCP/SCP
- Over Temperature Protection
- Remote On/Off
- Approved to IEC/EN 60950-1
- Approved to IEC/EN 62368-1
- Approved to UL/CSA 60950-1
- Class II, Category 2, Isolated DC/DC Converter (refer to IPC-9592B)

Applications

- Networking
- Computers and Peripherals
- Telecommunications



bel POWER
SOLUTIONS &
PROTECTION

a bel group

belfuse.com/power-solutions

1. MODEL SELECTION

MODEL NUMBER	OUTPUT VOLTAGE	INPUT VOLTAGE	MAX. OUTPUT CURRENT	MAX. OUTPUT POWER	TYPICAL EFFICIENCY
ORCY-60U12CG	12 VDC	18 - 75 VDC	7 A	84 W	92%

PART NUMBER EXPLANATION

0	R	CY	-	60	U	12	C	G
Mounting Type	RoHS Status	Series Name		Output Power	Input Range	Output Voltage	Active Logic	Package Type
Through Hole Mount	RoHS	1/8 th Brick		84 W	18 – 75 V	12 V	Active Low, with Baseplate	Tray Package

2. ABSOLUTE MAXIMUM RATINGS

PARAMETER	DESCRIPTION	MIN	TYP	MAX	UNITS
Input Voltage (Continuous)		-0.3	-	80	V
Input Transient Voltage	100 ms maximum	-	-	100	V
Remote On/Off		-0.3	-	18	V
I/O Isolation Voltage		-	-	1500	V
Ambient Temperature		-40	-	85	°C
Storage Temperature		-55	-	125	°C
Altitude		-	-	2000	m

NOTE: Ratings used beyond the maximum ratings may cause a reliability degradation of the converter or may permanently damage the device.

3. INPUT SPECIFICATIONS

All specifications are typical at 25°C unless otherwise stated.

PARAMETER	DESCRIPTION	MIN	TYP	MAX	UNIT
Input Voltage		18	24 / 48	75	V
Input Current (full load)		-	-	6.7	A
Input Current (no load)		-	100	180	mA
Remote Off Input Current		-	10	15	mA
Input Reflected Ripple Current (pk-pk)	With simulated source impedance of 10 μ H, 5 Hz to 20 MHz. Use a 100 μ F/100 V electrolytic capacitor with ESR = 1 ohm max, at 200 kHz @ 25°C.	-	15	30	mA
Input Reflected Ripple Current (rms)		-	5	10	mA
I ² t Inrush Current Transient		-	0.05	0.1	A ² s
Turn-on Voltage Threshold		16.0	17.0	17.5	V
Turn-off Voltage Threshold		15.0	16.0	16.5	V
Input Over Voltage Lockout		76	78	80	V

CAUTION: This converter is not internally fused. An input line fuse must be used in application.

Recommend a fast-acting fuse with max. rating of 8 A on system board. Refer to the fuse manufacture's datasheet for further information.

NOTES: 1. This converter has internal C-L-C (2.2 μ H-2*0.47 μ F+2.2 μ F) filter.

2. All specifications are typical at 25°C unless otherwise stated.

4. OUTPUT SPECIFICATIONS

All specifications are typical at nominal input, full load at 25°C unless otherwise stated.

PARAMETER	DESCRIPTION	MIN	TYP	MAX	UNIT
Output Voltage Set Point	Vin = 48 V, Io = 50% load	11.76	12.00	12.24	V
Line Regulation		-	±12	±24	mV
Load Regulation		-	±6	±12	mV
Regulation Over Temperature		-	±30	±50	mV
Output Current Range		0	-	7	A
Short Circuit Surge Transient		-	3	5	A ² s
Ripple and Noise (rms)	0 – 20 MHz BW, with a 1 µF ceramic capacitor and a 10 µF Tantalum cap at output.	-	30	50	mV
Ripple and Noise (pk-pk)		-	100	150	mV
Output Ripple and Noise (pk-pk) under worst case	Over entire operating input voltage range, load and ambient temperature condition	-	-	200	mV
Turn on Time	Ton (Enable from Vin)	-	20	30	ms
	Ton (Enable from ON/OFF)	-	20	30	ms
Overshoot at Turn on		-	0	3	%
Rise Time		5	10	15	ms
Output Capacitance		220	-	7000	µF
Transient Response					
ΔV 75%~50% of Max Load		-	300	400	mV
Settling Time	di/dt = 1 A/µs, Vin = 48 VDC, Ta = 25°C, with a 1 µF ceramic capacitor and a 10 µF Tantalum cap at output.	-	100	150	µs
ΔV 50%~75% of Max Load		-	300	400	mV
Settling Time		-	100	150	µs

5. GENERAL SPECIFICATIONS

PARAMETER	DESCRIPTION	MIN	TYP	MAX	UNIT	
Efficiency	The efficiency is measured at $V_{in} = 48\text{ V}$, full load and $T_a = 25^\circ\text{C}$.	$V_{in} = 48\text{ V}$; $I_o = I_o, \text{max}$	90.5	92	-	%
Efficiency	The efficiency is measured at $V_{in} = 24\text{ V}$, full load and $T_a = 25^\circ\text{C}$.	$V_{in} = 24\text{ V}$; $I_o = I_o, \text{max}$	90	91.5	-	%
Switching Frequency		240	258	280		kHz
Over Temperature Protection		-	125	-		$^\circ\text{C}$
Over Voltage Protection	This voltage is achieved by trimming up output slowly.	-	-	13.8		V
FIT	Calculated Per Bell Core SR-332 ($V_{in} = 48\text{ V}$, $V_o = 12\text{ V}$, $I_o = 7\text{ A}$, $T_a = 25^\circ\text{C}$, $\text{FIT} = 10^9/\text{MTBF}$)	-	452	-		-
Weight		-	31.2	-		g
Dimensions (L x W x H)			2.30 x 0.90 x 0.50			inch
			58.42 x 22.86 x 12.70			mm
<i>Isolation Characteristics</i>						
Input to Output		-	-	1500		VDC
Input to Case		-	-	1500		VDC
Output to Case		-	-	500		VDC
Isolation Resistance		10	-	-		ohm
Isolation Capacitance		-	1500	-		pF

NOTE: All specifications are typical at 25°C unless otherwise stated.

6. EFFICIENCY DATA

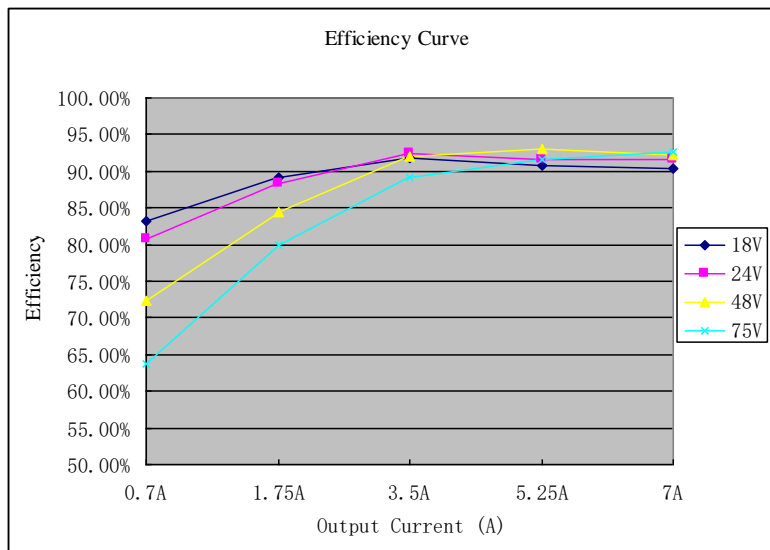

Figure 1. Efficiency data

7. REMOTE ON/OFF

PARAMETER	DESCRIPTION	MIN	TYP	MAX	UNIT
Signal Low (Unit On)	Active Low	-0.3	-	0.8	VDC
Signal High (Unit Off)	The remote on/off pin open, Unit off.	2.4	-	18	VDC
Current Sink		0	-	2	mA

Recommended Remote On/Off Circuit for Active Low:

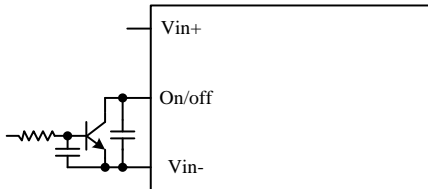

Figure 2. Control with open collector/drain circuit

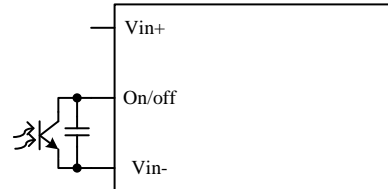

Figure 3. Control with photocoupler circuit

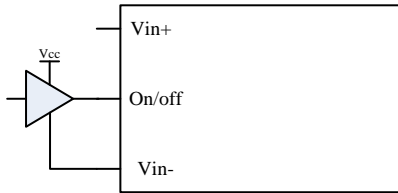

Figure 4. Control with logic circuit

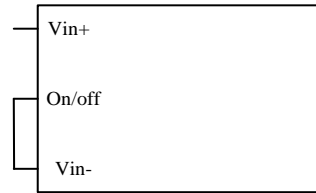

Figure 5. Permanently on

8. REMOTE SENSE

This module has remote sense compensation feature which can minimize the effects of resistance between output and load in system layout and facilitate accurate voltage regulation at load terminals or other selected point.

1. The remote sense lines carry very little current and hence do not require a large cross-sectional area.
2. This module compensates for a maximum drop of 10% of the nominal output voltage.
3. If the unit is already trimmed up, the available remote sense compensation range should be correspondingly reduced. The total voltage increased by trim and remote sense should not exceed 10% of the nominal output voltage.
4. When using remote sense compensation, all the resistance, parasitic inductance and capacitance of the system are incorporated within the feedback loop of this module which can make an effect on the module's compensation, affecting the stability and dynamic response. A 0.1 uF ceramic capacitor can be connected at the point of load to de-couple noise on the sense wires.
5. Recommend the connection of remote sense compensation as below figure. There are a resistor $RS+$ (30.1 ohm) from $Vo+$ to $Sense+$ and a resistor $RS-$ (30.1 ohm) from $Vo-$ to $Sense-$ inside of this module.

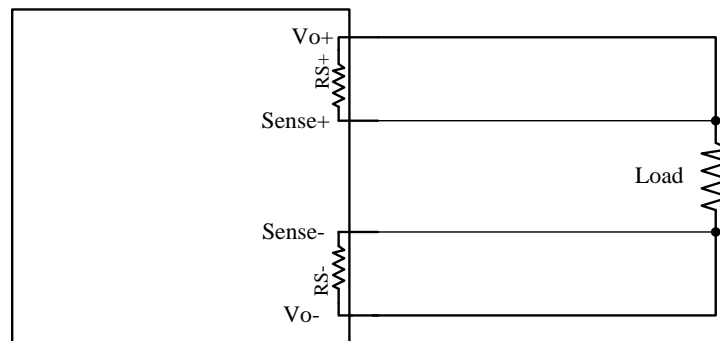

Figure 6.

6. If not using remote sense compensation, please connect sense directly to output at module's pin, that is, connect sense+ to $Vo+$ and sense- to $Vo-$ at module's pin, the shorter the better. see below figure.

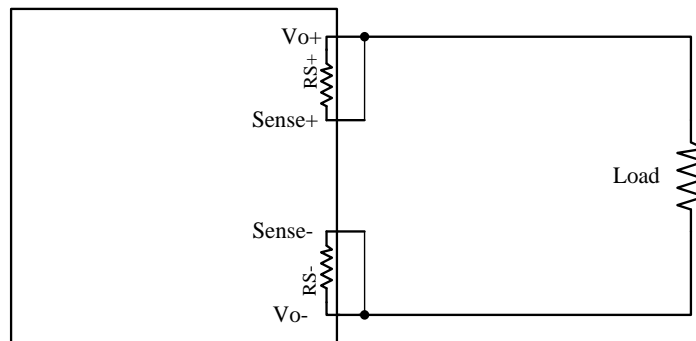

Figure 7.

9. OUTPUT TRIM EQUATIONS

Equations for calculating the trim resistor are shown below. The Trim Down resistor should be connected between the Trim pin and Sense (-) pin. The Trim Up resistor should be connected between the Trim pin and the Sense (+). Only one of the resistors should be used for any given application.

Minimum trim down voltage is 10.8 V
 Maximum trim up voltage is 13.2 V.

The total voltage increased by trim and remote sense should not exceed 10% of the nominal output voltage.

Trim down test circuit

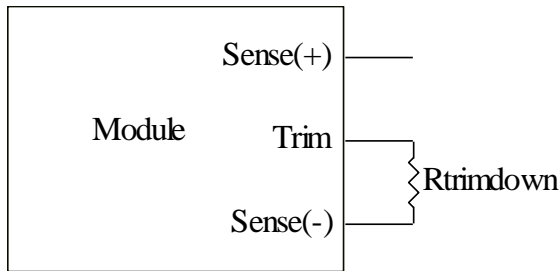

Figure 8. Trim down test circuit

$$R_{trimdown} = \frac{511}{|\delta|} - 10.22 [k\Omega]$$

Trim up test circuit

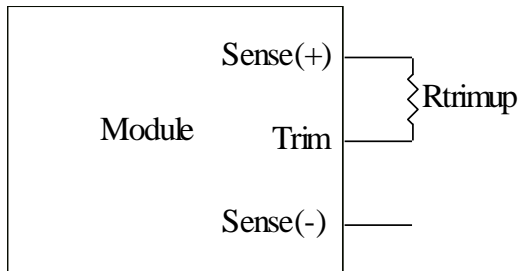

Figure 10. Trim up test circuit

$$R_{trimup} = \frac{(100 + \delta) \cdot V_o \cdot 5.11 - 626}{1.225 \cdot \delta} - 10.22 [k\Omega]$$

NOTE:

Vo_req=Desired (trimmed) output voltage [V]
 Output voltage Vo=12

$$\delta = \frac{(V_o_req - V_o)}{V_o} \times 100 [\%]$$

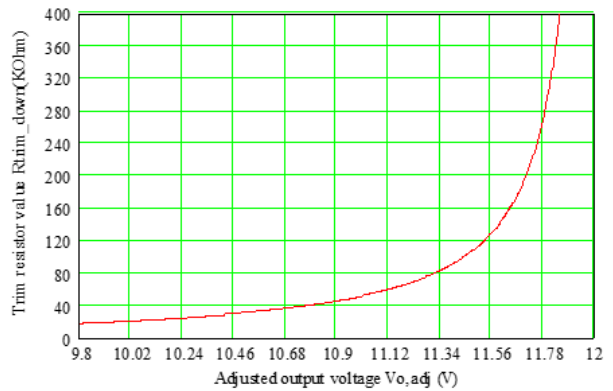

Figure 9. Trim down curve

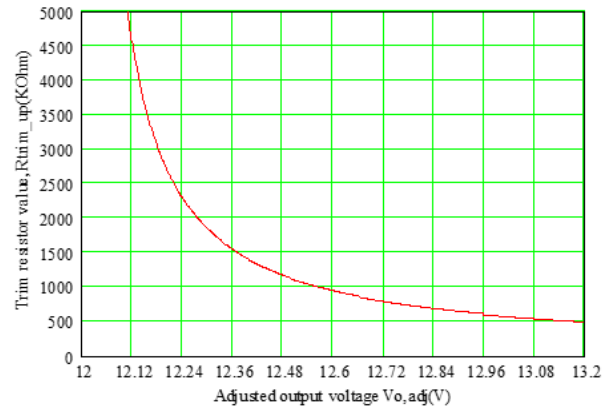

Figure 11. Trim up curve

10. THERMAL DERATING CURVES

Maximum FET junction temperature be derated to 120 °C.

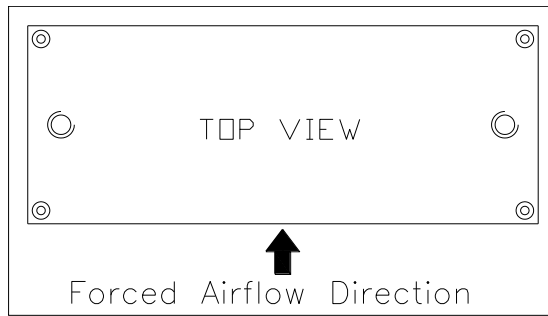

Figure 12. Forced airflow direction

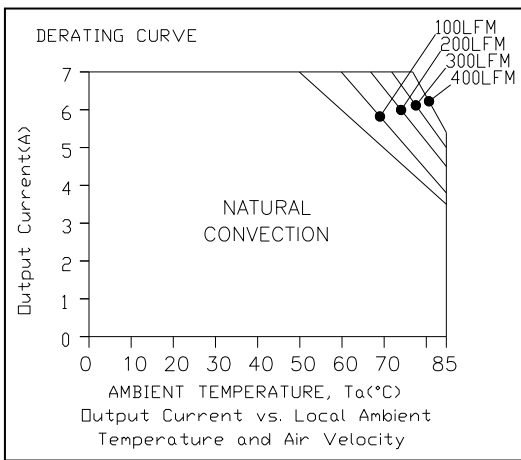

Figure 13. $V_{in} = 24 V$

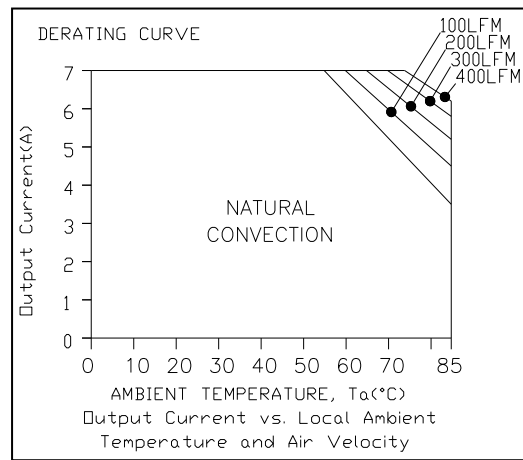

Figure 14. $V_{in} = 48 V$

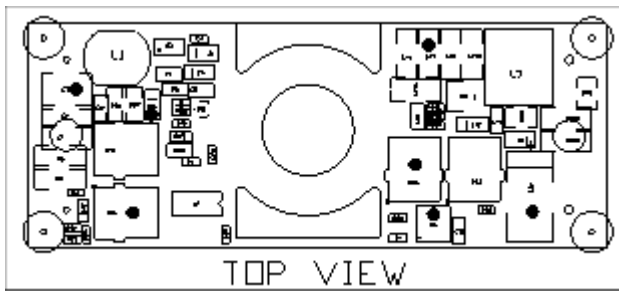

Figure 15. Temperature reference points on top side

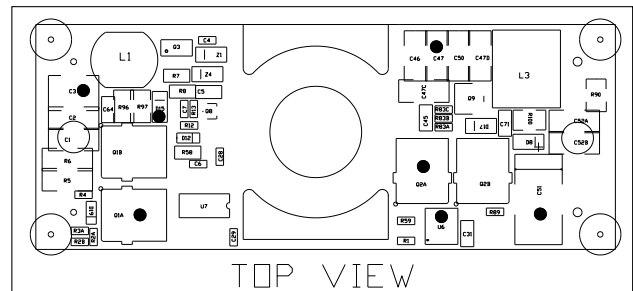

Figure 16. Temperature reference points on top side

11. RIPPLE AND NOISE WAVEFORM

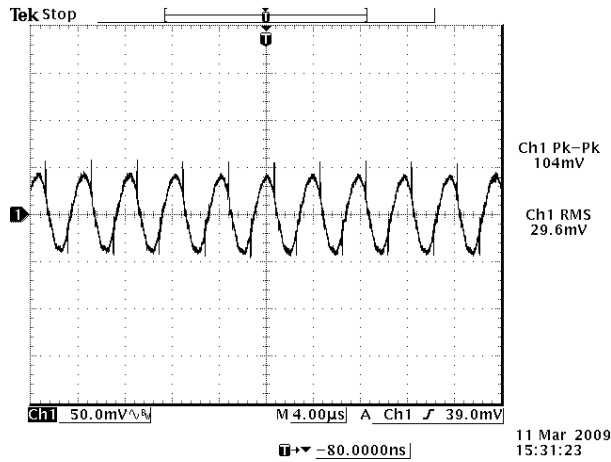

Figure 17. 24 VDC input, 12 VDC / 7 A output

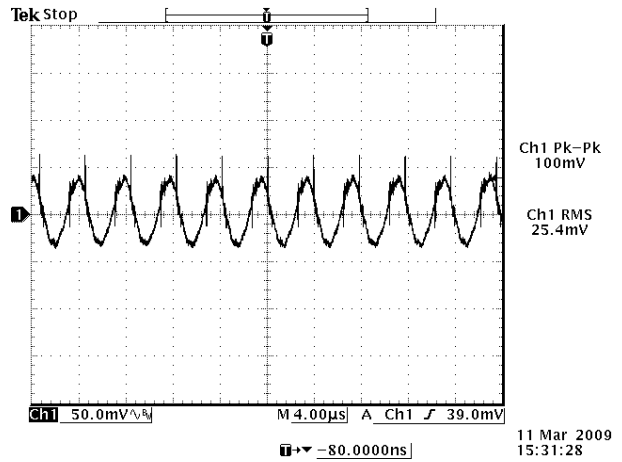

Figure 18. 48 VDC input, 12 VDC / 7 A output

Note: Ripple and noise at full load, 0-20 MHz BW, with a 1 µF ceramic cap and a 10 µF tantalum cap at the output, and Ta= 25 °C.

12. TRANSIENT RESPONSE WAVEFORMS

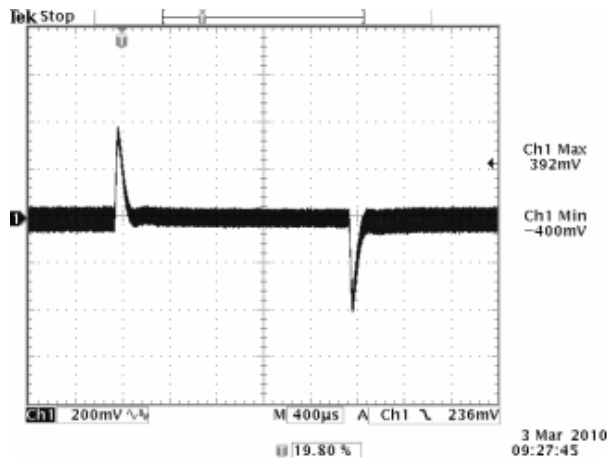

Figure 19. 50%-75% Load Transients at Vin = 24 V

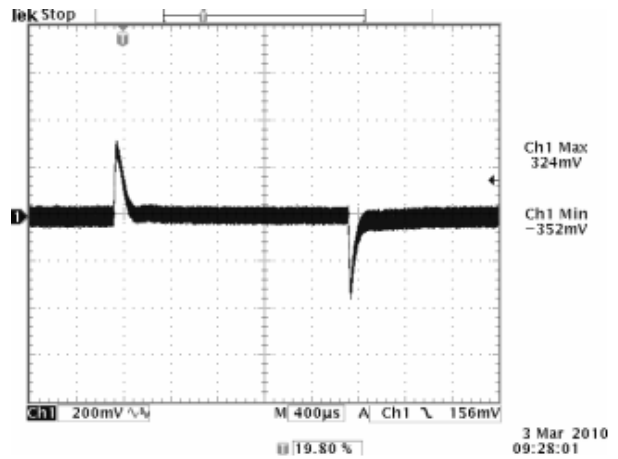

Figure 20. 75%-50% Load Transients at Vin = 48 V

Note: Transients Response at Vo = 12 V, di/dt = 0.1 A/µs, with a 0.1 µF ceramic cap and a 10 µF tantalum cap at output, and Ta = 25°C.

13. STARTUP & SHUTDOWN

Rise time

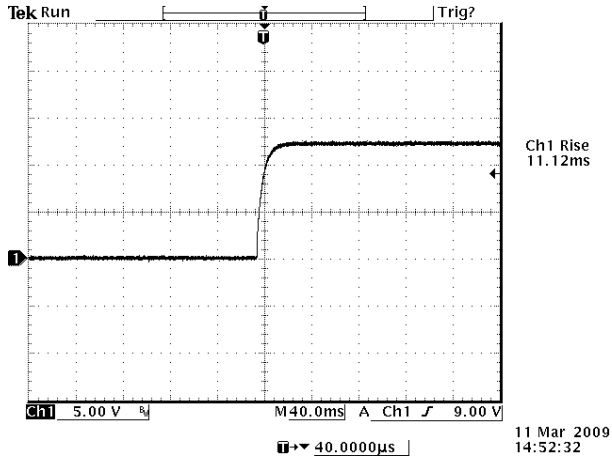

Figure 21. $V_{out} = 12\text{ V}$ full load at $V_{in} = 24\text{ V}$ @ $T_a = 25\text{ }^\circ\text{C}$

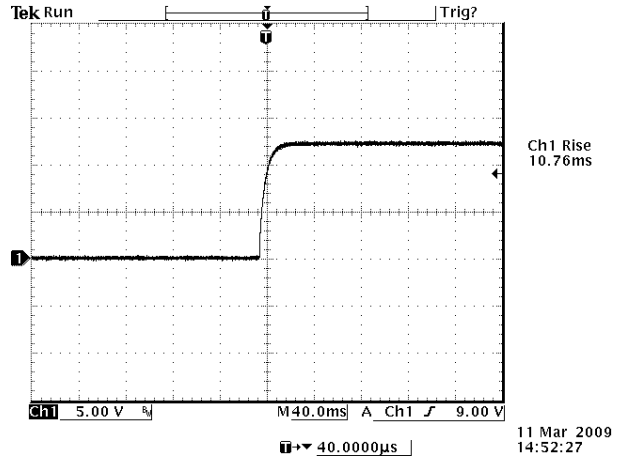

Figure 22. $V_{out} = 12\text{ V}$ full load at $V_{in} = 48\text{ V}$ @ $T_a = 25\text{ }^\circ\text{C}$

Startup time

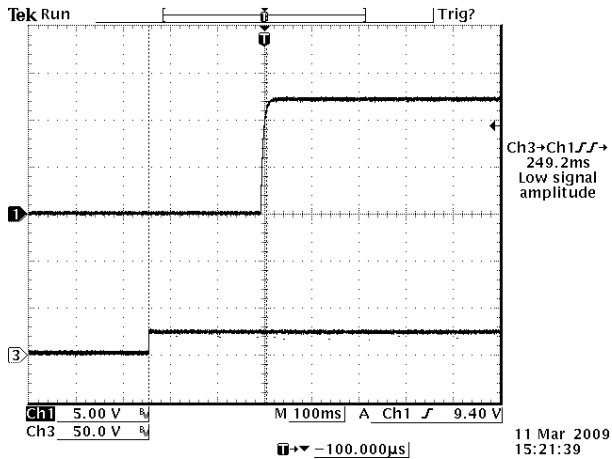

Figure 23. Startup from V_{in} ; Ch1: V_o ; Ch3: V_{in} , $V_{out} = 12\text{ V}$ full load at $V_{in} = 24\text{ V}$ @ $T_a = 25\text{ }^\circ\text{C}$

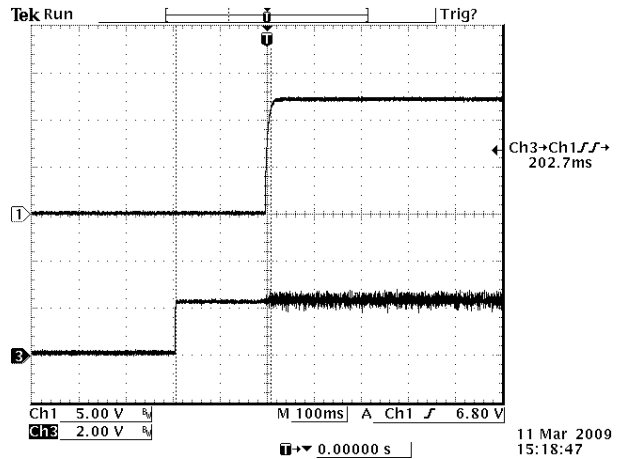

Figure 24. Startup from on/off; Ch1: V_o ; Ch3: on/off, $V_{out} = 12\text{ V}$ full load at $V_{in} = 24\text{ V}$ @ $T_a = 25\text{ }^\circ\text{C}$

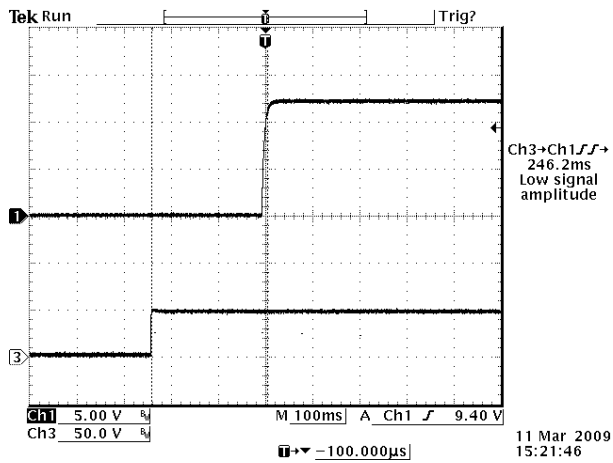

Figure 25. Startup from Vin; Ch1: Vo; Ch3: Vin;
Vout = 12V full load at Vin = 48 V @ Ta = 25 °C

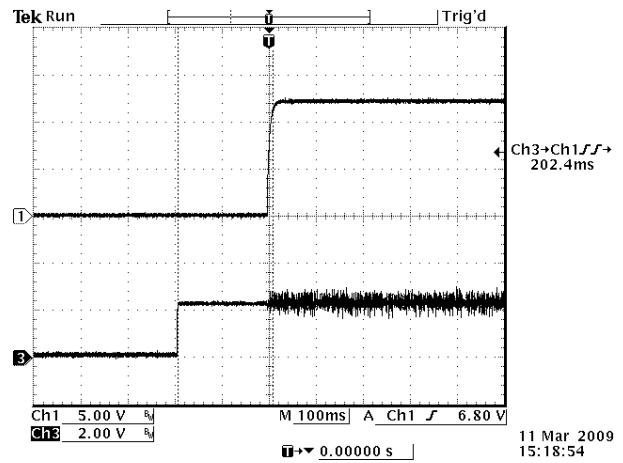

Figure 26. Startup from on/off; Ch1: Vo; Ch3: on/off;
Vout = 12 V full load at Vin = 48 V @ Ta = 25 °C

Shutdown

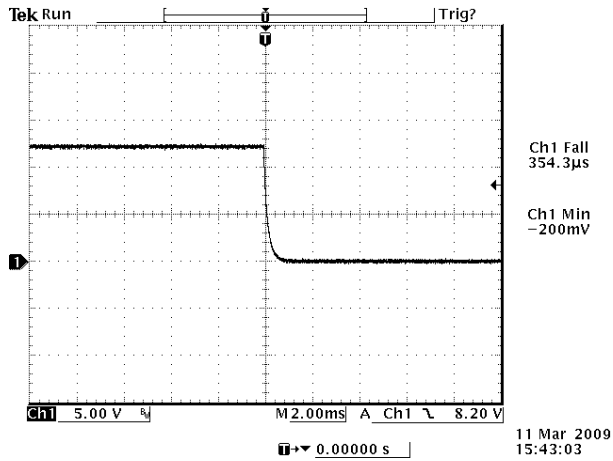

Figure 27. Vout = 12 V full load at Vin = 24 V @ Ta = 25 °C

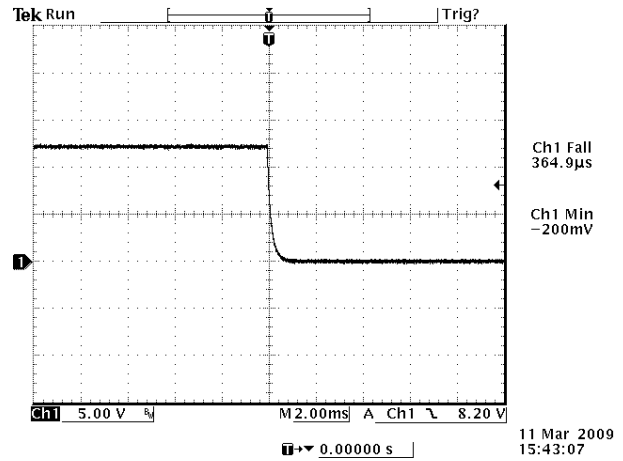

Figure 28. Vout = 12 V full load at Vin = 48 V @ Ta = 25 °C

14. OVER CURRENT PROTECTION

To provide protection in a fault output over load condition, the module is equipped with internal current-limiting circuitry which can endure current limiting for a few milliseconds. If the over current condition persists beyond a few milliseconds, the module will shut down into hiccup mode and restart once every 400 ms. The module operates normally when the output current goes into specified range.

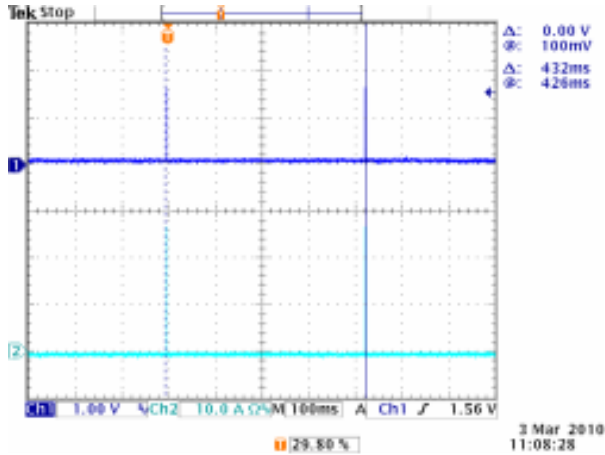

Figure 29. CH1: Output voltage waveform
CH2: Output current waveform
48V input with a Rout (0.171 ohm)

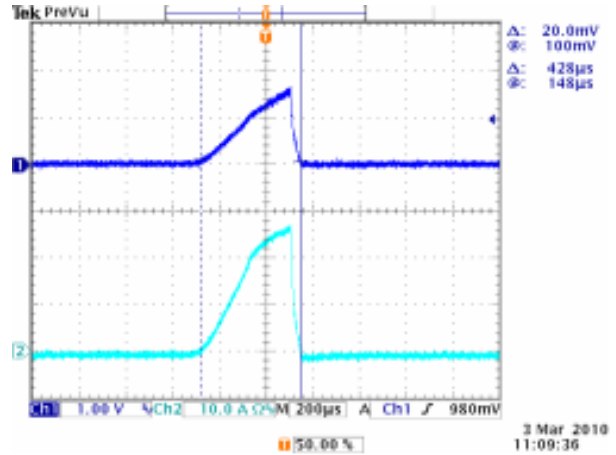

Figure 30. CH1: Output voltage waveform
CH2: Output current waveform
48V input with a Rout (0.171 ohm)
Expansion of on time portion of above figure

15. OVER TEMPERATURE PROTECTION

The OTP is achieved by thermistor RT and the threshold is set at 125 °C in non-latch mode; the hottest component Q1 reaches 125 °C with 100 LFM air flow correspondingly. It will restart automatically when the temperature falls to 100 °C. The protecting point will be varied a little under different conditions (air flow, ambient temperature, input voltage, load...).

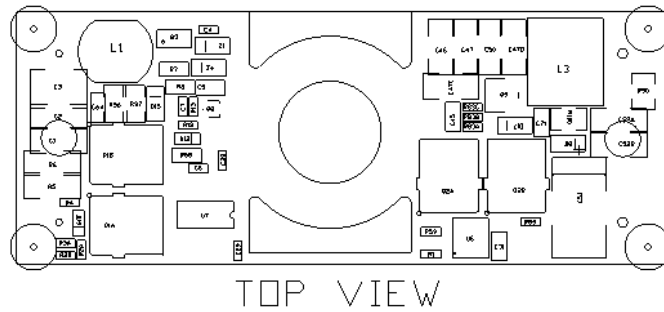

Figure 31. Top view

16. INPUT UNDER-VOLTAGE LOCKOUT

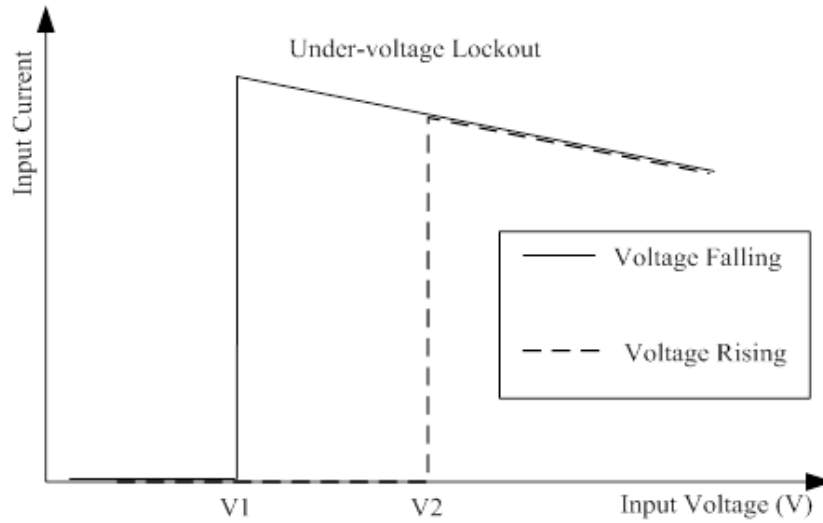

Figure 32. Input under-voltage lockout

V1 = 16 V
V2 = 17 V

17. OUTPUT OVERVOLTAGE PROTECTION

The output over voltage protection consists of circuitry that monitors the voltage on the output terminals. If the voltage on the output terminals exceeds the over voltage protection threshold, the module will shut down into hiccup mode and restart once every 400 ms. The module operates normally when the fault is cleared.

Setup:

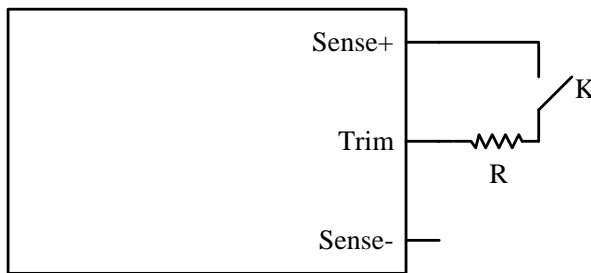

Figure 33. R = 350 K Ω

Waveform:

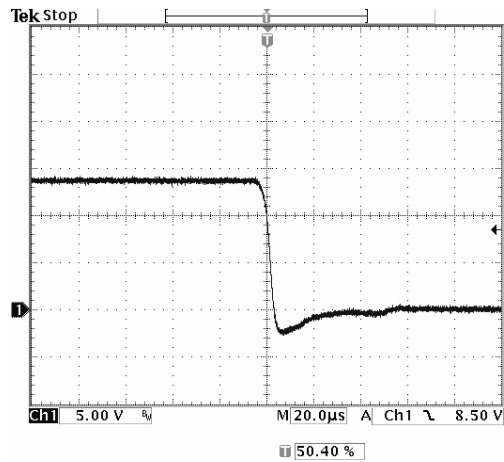

Figure 34. CH1: Output voltage waveform

3 Mar 2010
09:50:59

18. SAFETY & EMC

SAFETY:

Material flammability: UL94V-0

Compliance to IEC/EN 60950-1

Compliance to IEC/EN 62368-1

Compliance to UL/CSA 60950-1

EMC:

1. Surge: IEC61000-4-5

2. DC-DIP: IEC61000-4-29

3. Conductive EMI: EN 55032 class A

Compliance to EN 55032 class A (both peak and average) with the following inductive and capacitive filter,

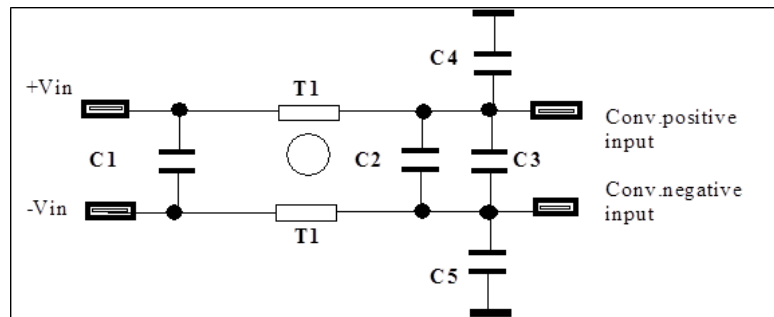

Figure 35.

ITEM	DESIGNATOR	PARAMETER	VENDOR	VENDOR P/N
1	C1	2.2 μ F/100V, ceramic	Murata	GRF32ER72A225KA11L
2	C2	47 μ F/100V, AL cap	Nichicon	UUJ2A470MNL1MS
3	C3	100 μ F/100V, AL cap	Nichicon	UVZ2A101MPD
4	C4	1000pF/2000V, ceramic	Johanson	202R18W102KV4E-****-RC
5	C5	1000pF/2000V, ceramic	Johanson	202R18W102KV4E-****-RC
6	T1	1.3mH, common mode	Pulse	P0420NL

Positive:

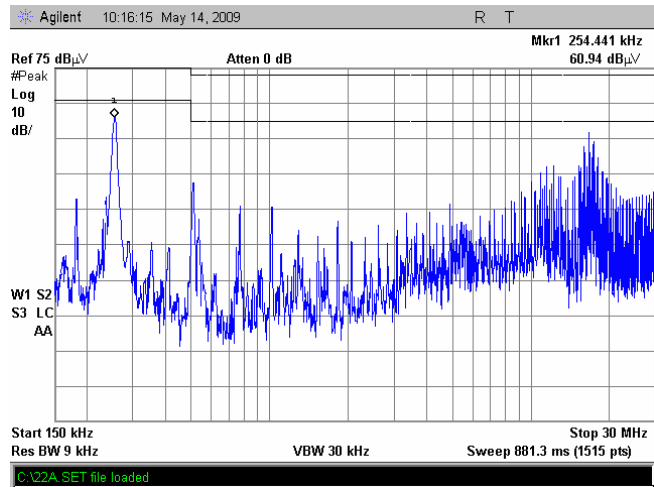

Figure 36.

Negative:

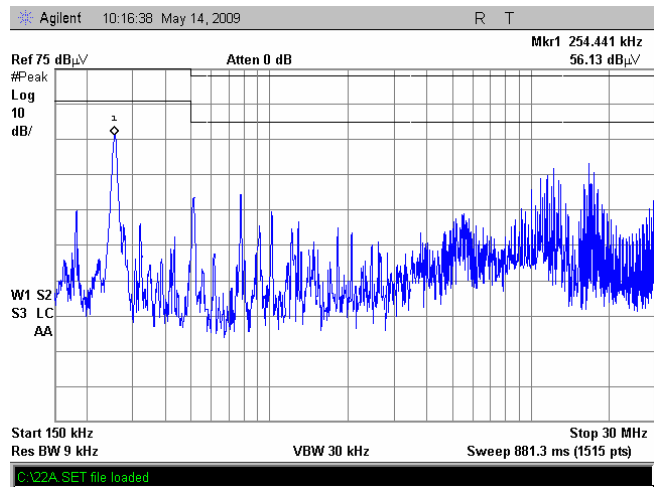

Figure 37.

19. MECHANICAL DIMENSIONS

OUTLINE

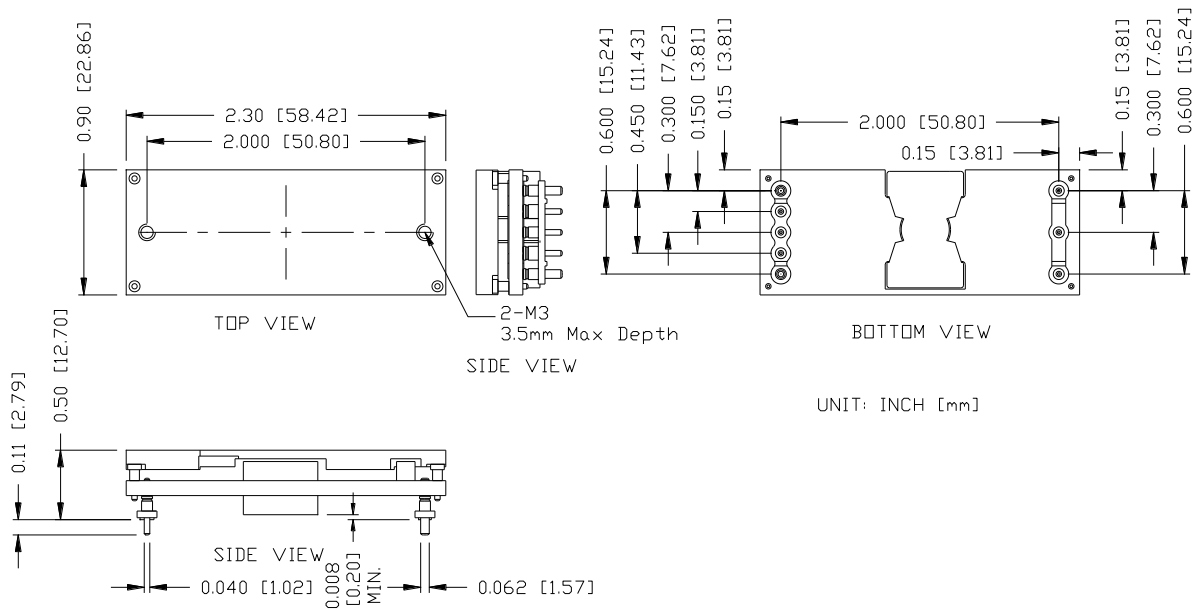

Figure 38. Outline

NOTE: This module is recommended and compatible with Pb-Free Wave Soldering and must be soldered using a peak solder temperature of no more than 260 °C for less than 5 seconds.

NOTES:

- 1) All Pins: Material - Copper Alloy;
Finish – 3 micro inches minimum Gold over 50 micro inches minimum Nickel plate.
- 2) Un-dimensioned components are shown for visual reference only.
- 3) All dimensions in inch [mm]; Tolerances: x.xx +/-0.02 inch [0.5 mm].
x.xxx +/-0.010 inch [0.25 mm].

PIN DEFINITIONS

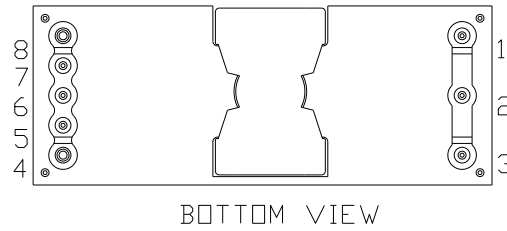

Figure 39. Pins

PIN	FUNCTION	PIN DIA	PIN	FUNCTION	PIN DIA
1	Vin+	0.040"	5	Sense-	0.040"
2	On/Off	0.040"	6	Trim	0.040"
3	Vin-	0.040"	7	Sense+	0.040"
4	Vout-	0.062"	8	Vout+	0.062"

NOTES:

1. Pin 5 must be connected to Vout-.
2. Leave Pin 6 open for nominal voltage.
3. Pin 7 must be connected to Vout+.

RECOMMENDED PAD LAYOUT

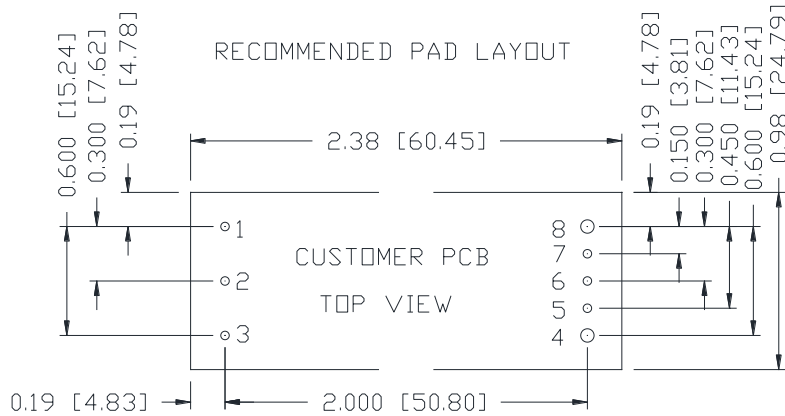

1,2,3,5,6,7 \varnothing 0.050 HOLE SIZE, \varnothing 0.10 min PAD SIZE
 4,8 \varnothing 0.074 HOLE SIZE, \varnothing 0.12 min PAD SIZE

Figure 40. Recommended pad layout

20. REVISION HISTORY

DATE	REVISION	CHANGES DETAIL	APPROVAL
2012-07-27	PA	First release.	XF.Jiang
2013-05-03	PB	Updated Cout to 7000 μ F.	XF.Jiang
2014-02-07	PC	Updated MD.	XF.Jiang
2019-07-01	AD	Update to new form.	XF.Jiang
2021-05-07	AE	Add object ID. Update safety certificate, mechanical outline and recommended pad layout.	XF.Jiang
2021-11-03	AF	Correct T1 vender PN in safety&EMC chapter. Change phone number.	XF.Jiang

For more information on these products consult: tech.support@psbel.com

NUCLEAR AND MEDICAL APPLICATIONS - Products are not designed or intended for use as critical components in life support systems, equipment used in hazardous environments, or nuclear control systems.

TECHNICAL REVISIONS - The appearance of products, including safety agency certifications pictured on labels, may change depending on the date manufactured. Specifications are subject to change without notice.



tech.support@psbel.com
belfuse.com/power-solutions

Mouser Electronics

Authorized Distributor

Click to View Pricing, Inventory, Delivery & Lifecycle Information:

[Bel Power Solutions:](#)

[0RCY-60U12CG](#)