

MEMS Thermal Sensors D6T

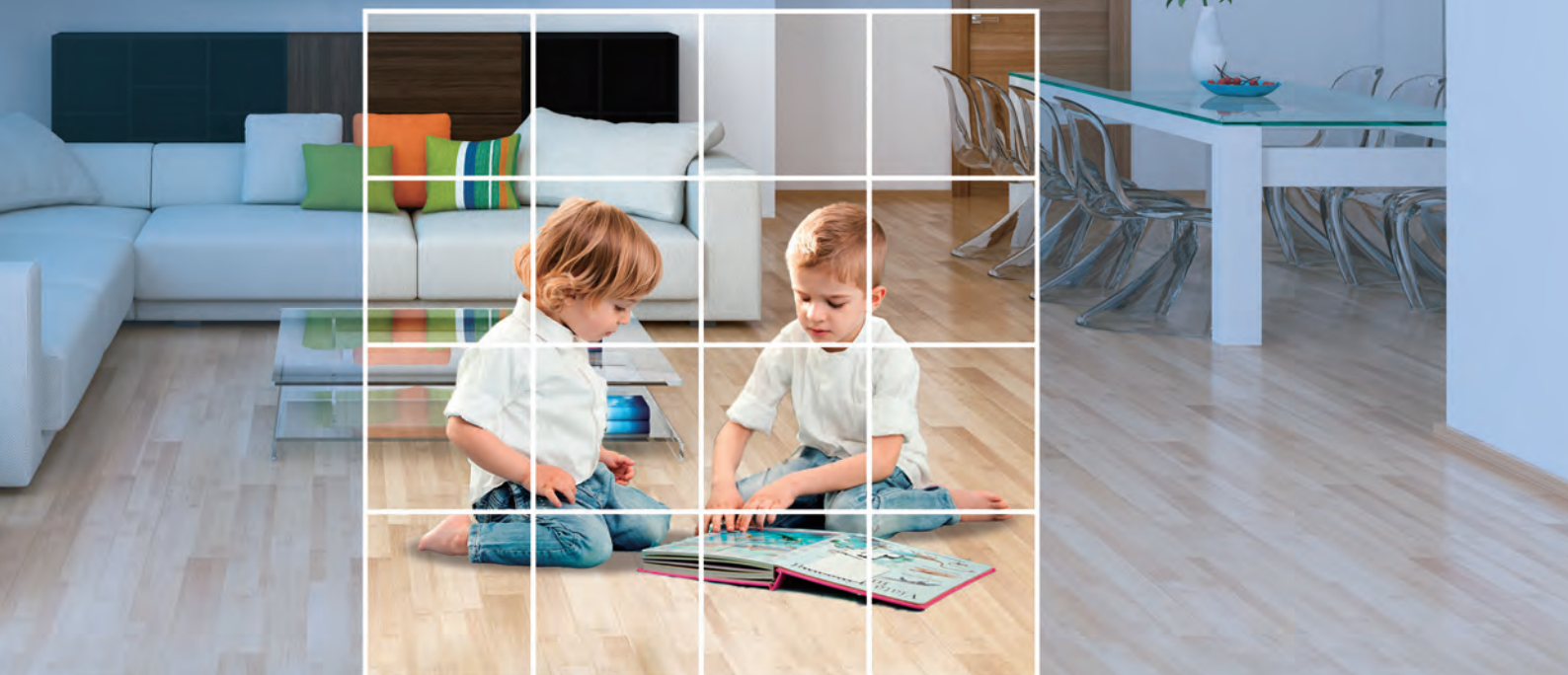

Contactless measurement
creating energy-efficient and comfortable living spaces



High Accuracy, Smaller Footprint, East to Work With

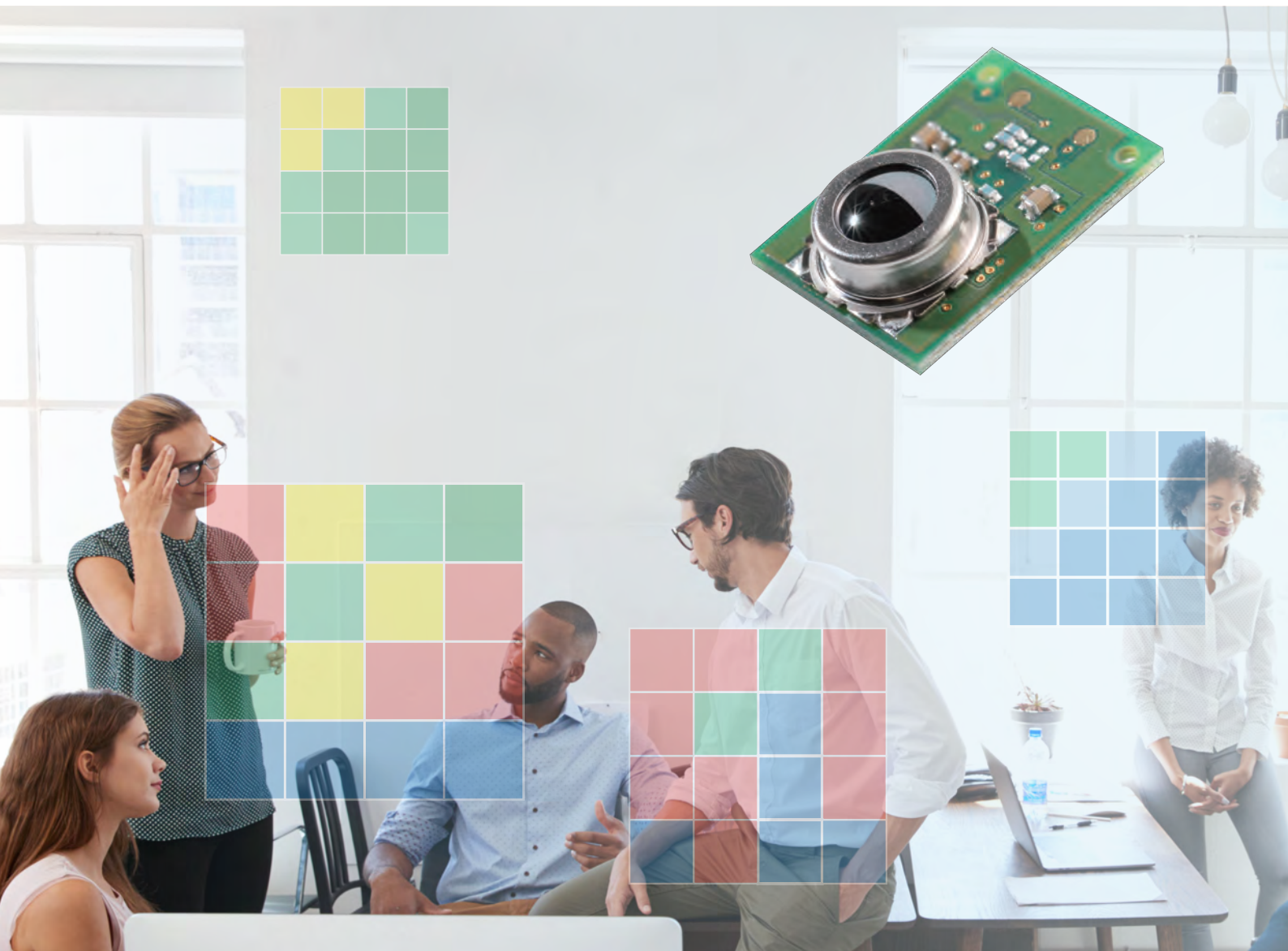

OMRON's unique MEMS technology allows combining thermopile elements and ASICs into one package resulting to ultra-compact footprint.

MEMS Thermal (IR* sensor) measures the surface temperature of objects without touching them when the thermopile element absorbs the amount of radiant energy from the object.

*IR: Infrared Ray

Low noise

Achieving the highest level of SNR* in the world *2

* SNR: Signal-to-Noise Ratio. Compares the level of a signal to the level of background noise
 *2 As of December 2017, according to OMRON research

Easy connection

Converts sensor signal to digital temperature output allowing easy use of microcontroller

Compact size

Space-saving design, well-suited for embedded applications

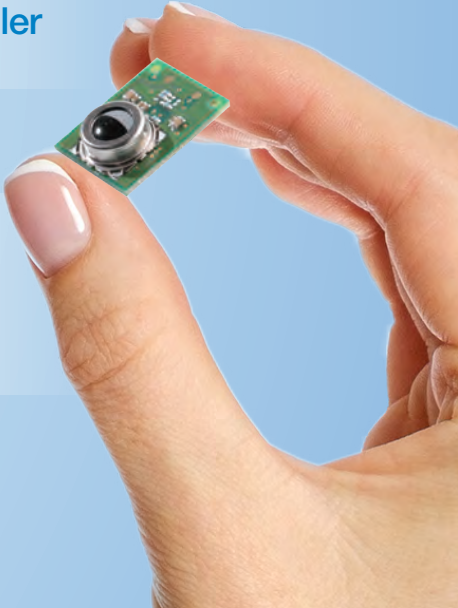

Cross-section view of D6T sensor

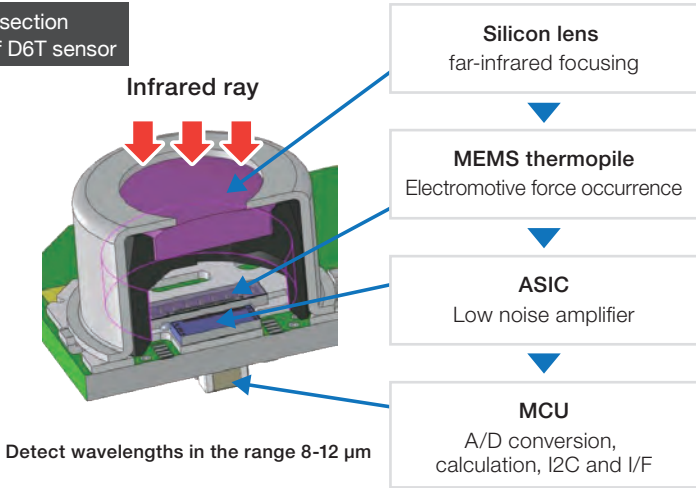

MEMS thermopile

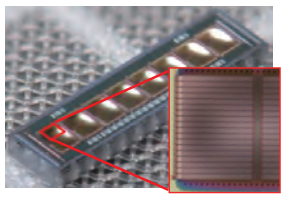

Detection principle

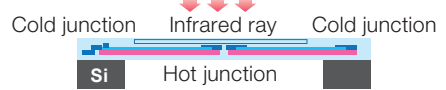

The sensor utilizes the seebeck effect in which thermoelectric force is generated due to the temperature difference that occurs across the junction points of two different types of metal.

Human Detection

D6T series sensors can detect human presence by sensing changes in human body temperature with respect to the surrounding temperature.





D6T application fields Air conditioners, lighting systems, security systems, nursing care and monitoring equipment

D6T series sensors can detect the slightest temperature changes that can be used in variety of applications including energy-efficient home appliances and security systems. The sensors can also be used in the application fields of HEMS (Home Energy Management System) and BEMS (Building Energy Management System).

Installation condition Recommended type: D6T-44L-06 (4x4-element / viewing angle: X=44.2° Y=45.7° / Object temperature range: 0 – 50degC)

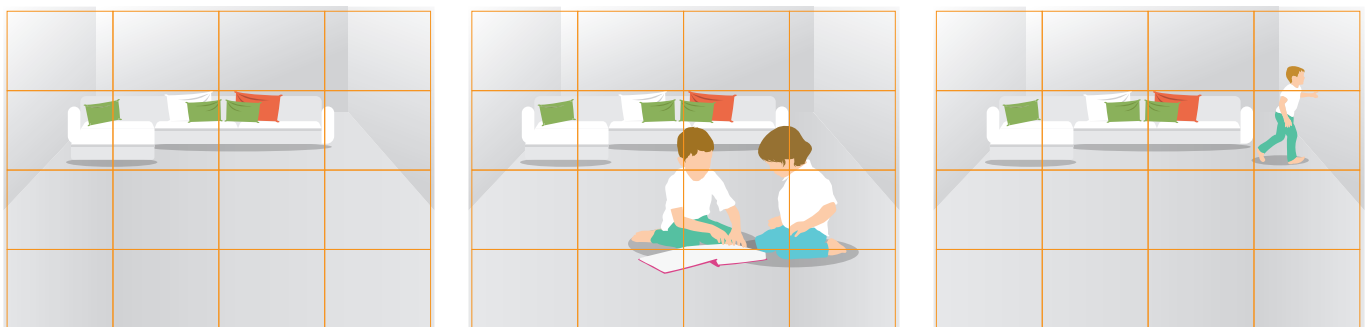
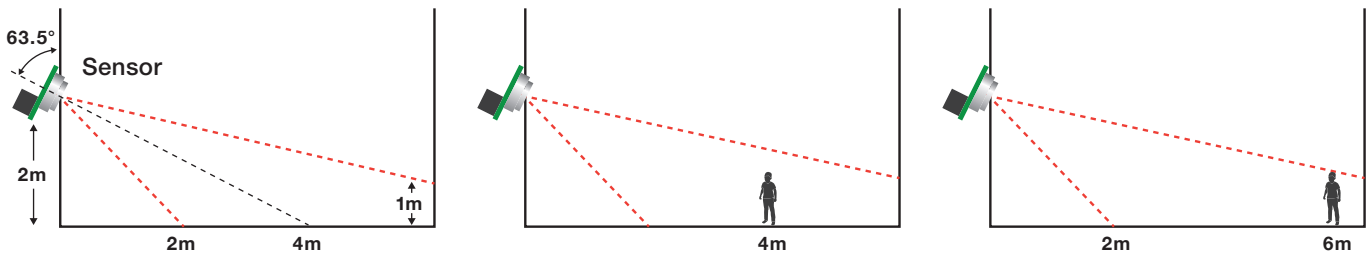

Detection results of temperature distribution

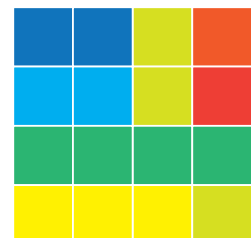
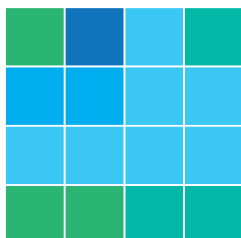

Object Detection

D6T sensors can detect objects by pinpointing the target object temperature.



D6T sensors let you measure temperature without the need to physically touch the object. This allows measuring temperature where it was not possible for contact thermal sensors due to space shortage. The sensors can be used in a wide range of applications including FEMS (Factory Energy Management System).



D6T sensor meets customer needs by providing a wide range of application support from home appliances to industrial use.



D6T application fields

Industrial equipment, non-contact thermometers, refrigerators, microwave ovens, IH cooking heaters, data centers

Comparison with Pyroelectric Sensor

Both the pyroelectric sensor and non-contact MEMS thermal sensor can detect even the slightest amount of radiant energy from objects such as infrared radiation and convert them into temperature readings. However, unlike pyroelectric sensor that relies on motion detection, non-contact MEMS thermal sensor is able to detect the presence of stationary humans (or objects).

Pyroelectric sensor Converts temperature readings only when detecting “**temperature changes** in the radiant energy” in its field of view.

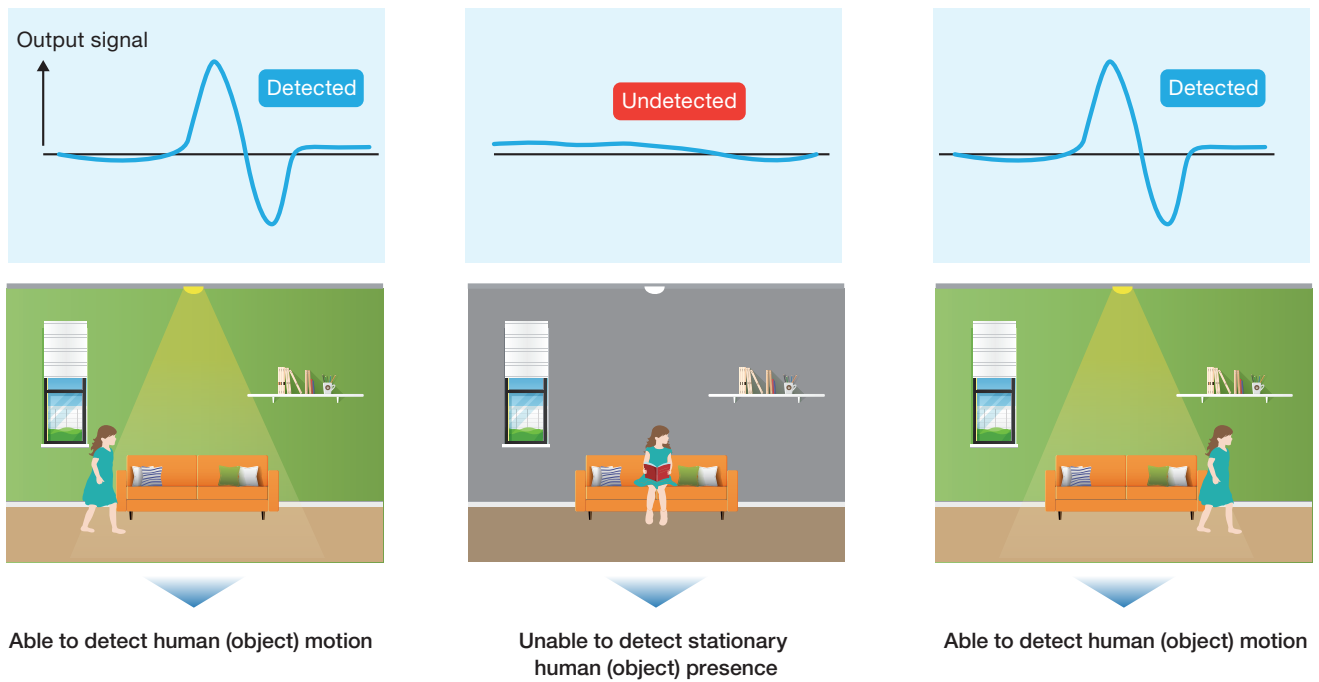



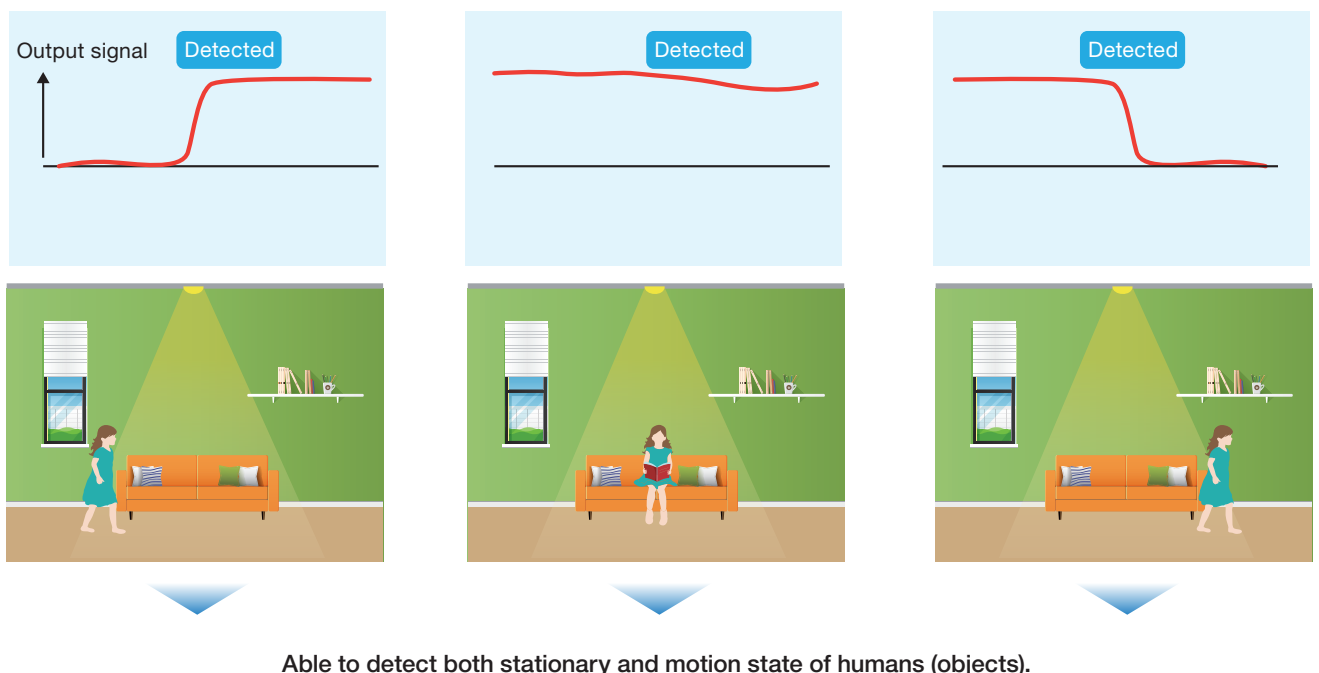

MEMS thermal sensor (thermopile) Converts temperature readings by “**continuously detecting** the temperature of radiant energy” in its field of view



Viewing Angle and Measurement Area

Choose your preferred sensor viewing angle to meet your application needs.

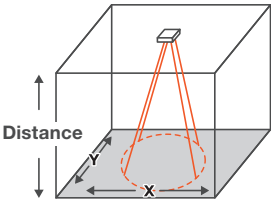
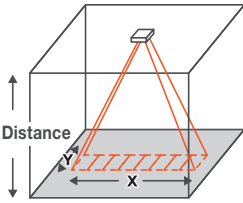
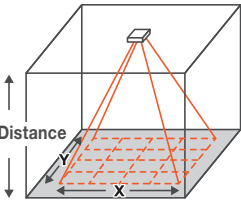
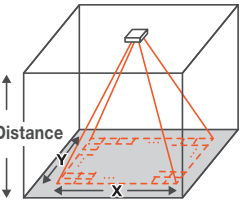
Sensor type	D6T-1A-01	D6T-1A-02	D6T-8L-09/09H	D6T-44L-06/06H	D6T-32L-01A
Appearance					
Number of elements	1(1x1)		8(1x8)	16(4x4)	1024(32x32)
Number of elements X-direction Y-direction	X = 58.0° Y = 58.0°	X = 26.5° Y = 26.5°	X = 54.5° Y = 5.5°	X=44.2° Y=45.7°	X=90.0° Y=90.0°
Size of measurement area					
Distance 1m	X = 111cm Y = 111cm	X = 47cm Y = 47cm	X = 103cm Y = 10cm	X = 81cm Y = 84cm	X = 200cm Y = 200cm
Distance 2m	X = 222cm Y = 222cm	X = 94cm Y = 94cm	X = 206cm Y = 20cm	X = 162cm Y = 169cm	X = 400cm Y = 400cm
Distance 3m	X = 333cm Y = 333cm	X = 141cm Y = 141cm	X = 309cm Y = 30cm	X = 244cm Y = 253cm	X = 600cm Y = 600cm

* The sizes of measurement area indicated above are for reference only.

* The size of measurement area changes according to sensor mounting angle.

High Sensitivity Enables Detection of Stationary Human Presence

- OMRON's unique MEMS and ASIC technology achieve a high SNR (except for the D6T-32L-01A).
- Superior noise immunity with a digital output.
- High-precision area temperature detection with low cross-talk field of view characteristics.



RoHS Compliant



Refer to *Safety Precautions* on page 17.

Ordering Information

Thermal Sensors

Element type	Model	Shape
1×1	D6T-1A-01	
	D6T-1A-02	
1×8	D6T-8L-09/09H	
4×4	D6T-44L-06/06H	
32×32	D6T-32L-01A	

Model Number Legend

D6T-□-□ □
(1) (2) (3)

(1) Number of elements

- 1A : 1 (1 × 1)
- 8L : 8 (1 × 8)
- 44L : 16 (4 × 4)
- 32L : 1024 (32 × 32)

(2) Viewing angle

- 01 : X direction, Y direction=58.0°
- 02 : X direction, Y direction=26.5°
- 09 : X direction=54.5°, Y direction=5.5°
- 06 : X direction=44.2°, Y direction=45.7°
- 01A : X direction, Y direction=90°

(3) Special Functions

- H : High-temperature type
- Non-display : Standard sensor

Accessories (Sold separately)

Type	Model
Cable Harness	D6T-HARNESS-02

Others

MEMS thermal sensors can be connected to OMRON sensor evaluation boards.

Following 3 types of platform are applicable. Evaluation can be performed easily by connecting thermal sensor, evaluation board, and harness to the platform.

Platform	Evaluation Board	Harness for connection (Evaluation Board - D6T)	Sample Source Code
For Raspberry Pi ^{*1}	2JCIE-EV01-RP1	2JCIE-HARNESS-01	https://github.com/omron-devhub/d6t-2jcieev01-raspberrypi
For Arduino ^{*2}	2JCIE-EV01-AR1	2JCIE-HARNESS-01	https://github.com/omron-devhub/d6t-2jcieev01-arduino
For ESP32 Feather ^{*3}	2JCIE-EV01-FT1	2JCIE-HARNESS-01	https://github.com/omron-devhub/d6t-2jcieev01-arduino

For details of evaluation boards and sample source codes, refer to the following website.

(<http://www.omron.co.jp/ecb/sensor/evaluation-board/2jcie>)

*1. Raspberry Pi is a registered trademark of the Raspberry Pi Foundation.

*2. Arduino is a registered trademark of Arduino LLC and Arduino SRL.

*3. Feather is a registered trademark of Adafruit Industries LLC.

Ratings, Specifications, and Functions

Ratings

Item	Model	D6T-1A-01	D6T-1A-02	D6T-8L-09	D6T-8L-09H	D6T-44L-06	D6T-44L-06H	D6T-32L-01A
Power supply voltage		4.5 to 5.5 VDC						
Storage temperature range		-20 to 80°C	-40 to 80°C	-20 to 80°C (with no icing or condensation)		-10 to 60°C		-20 to 80°C
Operating temperature range		0 to 60°C	-40 to 80°C	0 to 60°C (with no icing or condensation)		0 to 50°C		-10 to 70°C
Storage humidity range		95% max.	95% max.	95% max. (with no icing or condensation)		85% max.		95% max.
Operating humidity range		20% to 95%	20% to 95%	20% to 95% (with no icing or condensation)		20% to 85%		20% to 95%

Characteristics

Item	Model	D6T-1A-01	D6T-1A-02	D6T-8L-09	D6T-8L-09H	D6T-44L-06	D6T-44L-06H	D6T-32L-01A
View angle ^{*1}	X direction	58.0°	26.5°	54.5°		44.2°		90°
	Y direction	58.0°	26.5°	5.5°		45.7°		90°
Object temperature output accuracy ^{*2}	Accuracy 1	$\pm 1.5^\circ\text{C}$ max. Measurement conditions: $V_{cc} = 5.0\text{ V}$ (1) $T_x = 25^\circ\text{C}$, $T_a = 25^\circ\text{C}$ (2) $T_x = 45^\circ\text{C}$, $T_a = 25^\circ\text{C}$ (3) $T_x = 45^\circ\text{C}$, $T_a = 45^\circ\text{C}$						Within $\pm 3.0^\circ\text{C}$ Measurement conditions: $V_{cc} = 5.0\text{ V}$ $T_x = 25^\circ\text{C}$, $T_a = 25^\circ\text{C}$ Central 16x16-pixel area
Current consumption		3.5 mA typical		5 mA typical			19 mA typical	

Functions

Item	Model	D6T-1A-01	D6T-1A-02	D6T-8L-09	D6T-8L-09H	D6T-44L-06	D6T-44L-06H	D6T-32L-01A
Object temperature detection range ^{*2}		5 to 50°C	-40 to 80°C	5 to 50°C	5 to 200°C	5 to 50°C	5 to 200°C	0 to 200°C
Ambient temperature detection range ^{*2}		5 to 45°C	-40 to 80°C	5 to 45°C	5 to 45°C	5 to 45°C	5 to 45°C	0 to 80°C
Output specifications		Digital values that correspond to the object temperature (Tx) and reference temperature (Ta) are output from a serial communications port.						
Output form (Object temperature detection)		Binary code (10 times the detected temperature (°C))			Binary code (5 times the detected temperature (°C))	Binary code (10 times the detected temperature (°C))		
Output form (Reference temperature inside the sensor)		Binary code (10 times the detected temperature (°C))						
Communications form		I2C compliant						
Temperature resolution (NETD) ^{*3}		0.02°C (Data update cycle 100 msec)	0.06°C (Data update cycle 100 msec)	0.03°C (Data update cycle 250 msec)	0.03°C (Data update cycle 250 msec)	0.06°C (Data update cycle 300 msec)	0.06°C (Data update cycle 300 msec)	0.33°C ^{*4} (Data update cycle 200 msec)

*1. Refer to *Field of View Characteristics*.

*2. Refer to *Object Temperature Detection Range*.

*3. Reference data

*4. Taken to be the average value of the central 4 pixels.

Object Temperature Detection Range

D6T-44L-06, D6T-8L-09, D6T-1A-01

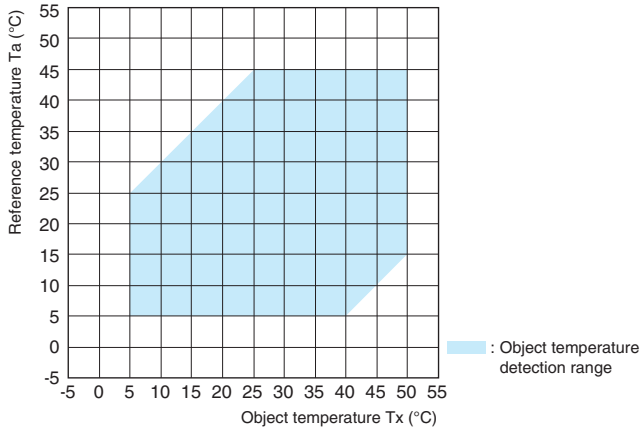

D6T-1A-02

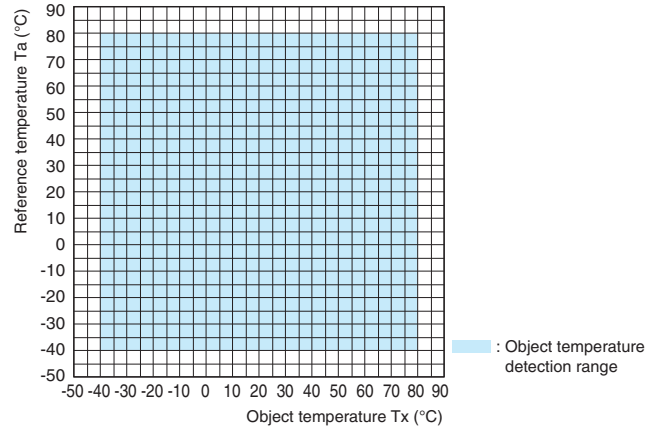

D6T-44L-06H, D6T-8L-09H

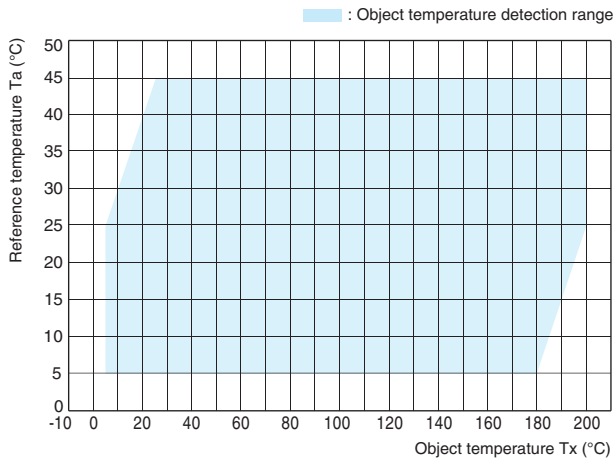

D6T-32L-01A

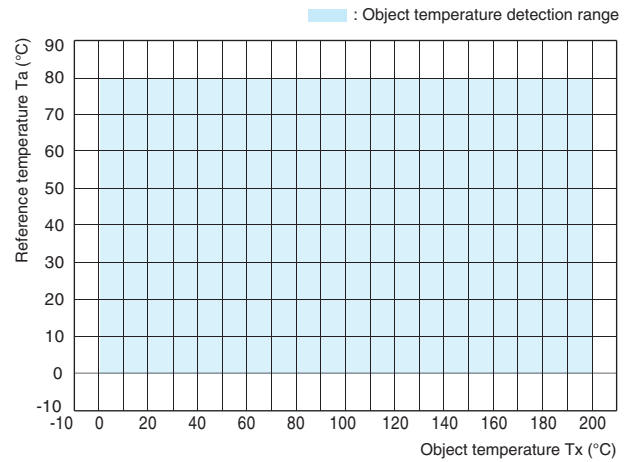

Connections

Thermal Sensor Configuration Diagram

<D6T-8L-09/09H>

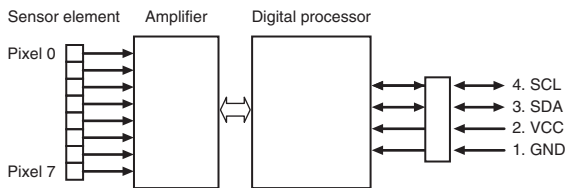

Note: The D6T-44L-06/06H has pixels 0 to 15.
 The D6T-1A-01/02 has pixel 0.
 The D6T-32L-01A has pixel 0 to 1023.

Terminal Arrangement

Terminal	Name	Function	Remarks
1	GND	Ground	
2	VCC	Positive power supply voltage input	
3	SDA	Serial data I/O line	Connect the open-drain SDA terminal to a pull-up resistor.
4	SCL	Serial clock input	Connect the open-drain SCL terminal to a pull-up resistor.

Field of View Characteristics

D6T-44L-06/06H

Field of view in X Direction

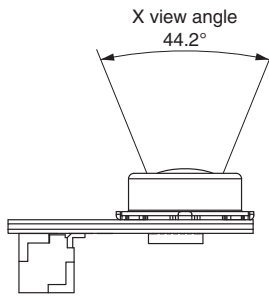

Field of view in Y Direction

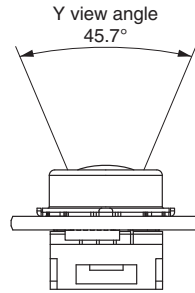

Detection Area for Each Pixel

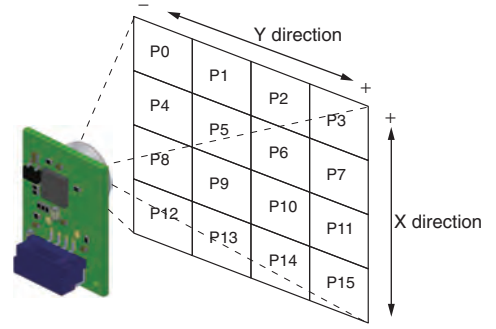

Note: Definition of view angle: Using the maximum Sensor output as a reference, the angular range where the Sensor output is 50% or higher when the angle of the Sensor is changed is defined as the view angle.

D6T-8L-09/09H

Field of view in X Direction

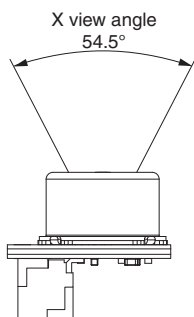

Field of view in Y Direction

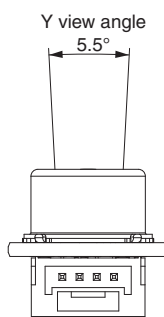

Detection Area for Each Pixel

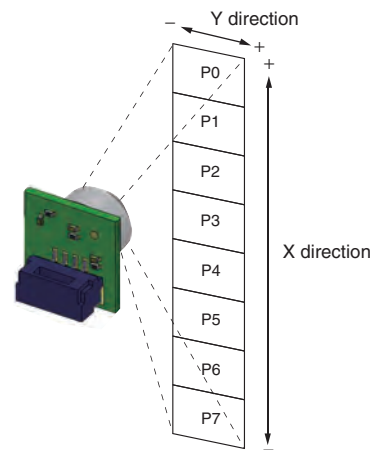

Note: Definition of view angle: Using the maximum Sensor output as a reference, the angular range where the Sensor output is 50% or higher when the angle of the Sensor is changed is defined as the view angle.

D6T-1A-01

Field of view in X Direction

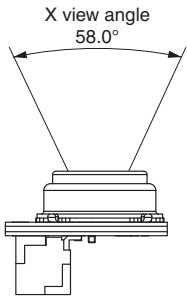

Field of view in Y Direction

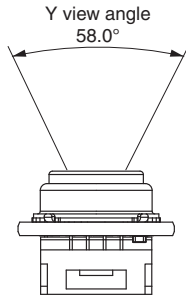

D6T-1A-02

Field of view in X Direction

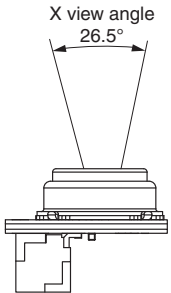

Field of view in Y Direction

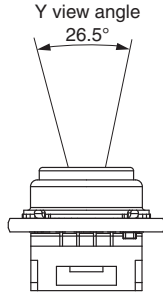

Detection Area for Each Pixel

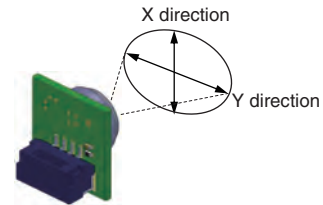

Note: Definition of view angle: Using the maximum Sensor output as a reference, the angular range where the Sensor output is 50% or higher when the angle of the Sensor is changed is defined as the view angle.

D6T-32L-01A

Field of view in X Direction

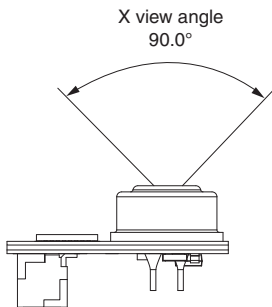

Field of view in Y Direction

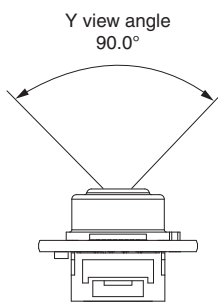

Detection Area for Each Pixel

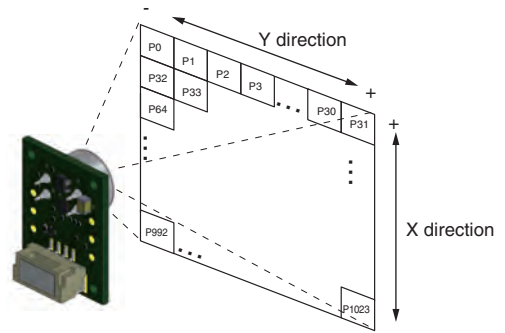

Note: Definition of view angle: Using the maximum Sensor output as a reference, the angular range where the Sensor output is 50% or higher when the angle of the Sensor is changed is defined as the view angle.

D6T-1A-01/02

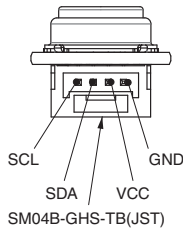
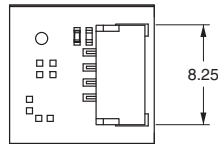
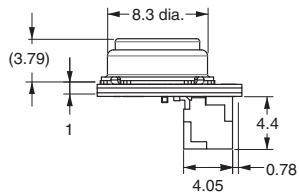
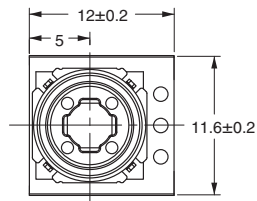
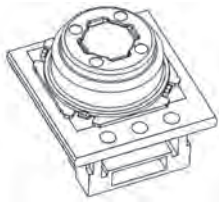

Supporting and Mounting Area (Shaded Portion)
Top View

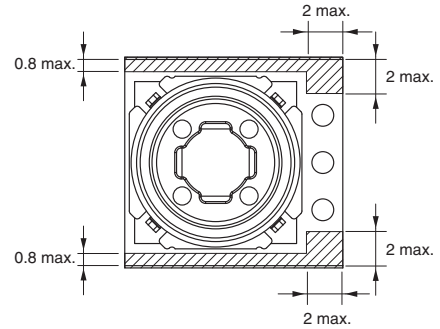

Bottom View

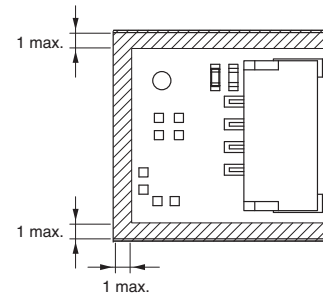

Note: Due to insulation distance limitations, do not allow metal parts to come into contact with the Sensor.

D6T-32L-01A

D6T

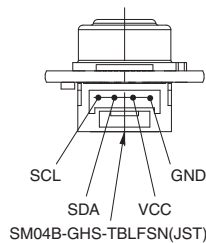
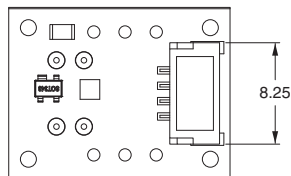
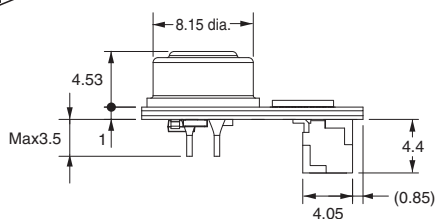
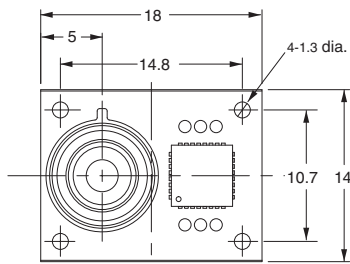
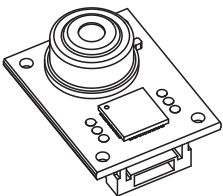

Supporting and Mounting Area (Shaded Portion)
Top View

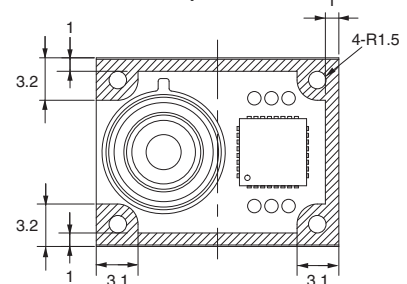

Bottom View

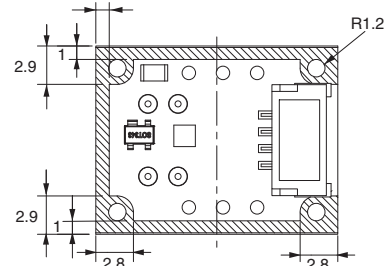

Note: Due to insulation distance limitations, do not allow metal parts to come into contact with the Sensor.

D6T-HARNESS-02 (Optional - sold separately)

Cable Color

GND → BLACK Wire
VCC → RED Wire
SDA → BLUE Wire
SCL → YELLOW Wire

* Length of Cable removed sheath.

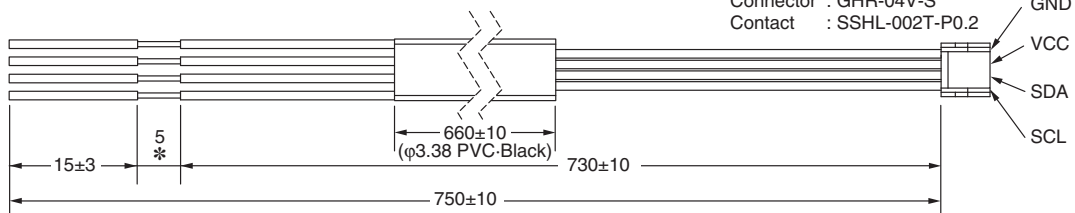

Cable :UL1061.AWG#28
UL Tube : T-105-2 No.8
Connector : GHR-04V-S
Contact : SSSL-002T-P0.2

Note: Unless otherwise specified, a tolerance of ±0.3 mm applies to all dimensions.

Safety Precautions

Precautions for Correct Use

● Installation

- The Sensor may not achieve the characteristics given in this datasheet due to the ambient environment or installation location. Before using the Sensor, please acquire an adequate understanding and make a prior assessment of Sensor characteristics in your actual system.

● Operating Environment

- Do not use the Sensor in locations where dust, dirt, oil, and other foreign matter will adhere to the lens. This may prevent correct temperature measurements.
- Do not use the Sensor in any of the following locations.
 - Locations where the Sensor may come into contact with water or oil
 - Outdoors
 - Locations subject to direct sunlight.
 - Locations subject to corrosive gases (in particular, chloride, sulfide, or ammonia gases).
 - Locations subject to extreme temperature changes
 - Locations subject to icing or condensation.
 - Locations subject to excessive vibration or shock.

● Noise Countermeasures

- The Sensor does not contain any protective circuits. Never subject it to an electrical load that exceeds the absolute maximum ratings for even an instance. The circuits may be damaged. Install protective circuits as required so that the absolute maximum ratings are not exceeded.
- Keep as much space as possible between the Sensor and devices that generates high frequencies (such as high-frequency welders and high-frequency sewing machines) or surges.
- Attach a surge protector or noise filter on nearby noise-generating devices (in particular, motors, transformers, solenoids, magnetic coils, or devices that have an inductance component).
- In order to prevent inductive noise, separate the connector of the Sensor from power lines carrying high voltages or large currents. Using a shielded line is also effective.
- If a switching regulator is used, check that malfunctions will not occur due to switching noise from the power supply.

● Handling

- This Sensor is a precision device. Do not drop it or subject it to excessive shock or force. Doing so may damage the Sensor or change its characteristics. Never subject the connector to unnecessary force. Do not use a Sensor that has been dropped.
- Take countermeasures against static electricity before you handle the Sensor.
- Turn OFF the power supply to the system before you install the Sensor. Working with the Sensor while the power supply is turned ON may cause malfunctions.
- Secure the Sensor firmly so that the optical axis does not move.
- Install the Sensor on a flat surface. If the installation surface is not even, the Sensor may be deformed, preventing correct measurements.
- Do not install the Sensor with screws. Screws may cause the resist to peel from the board. Secure the Sensor in a way that will not cause the resist to peel.
- Always check operation after you install the Sensor.
- Use the specified connector (GHR-04 from JST) and connect it securely so that it will not come off. If you solder directly to the connector terminals, the Sensor may be damaged.
- Make sure to wire the polarity of the terminals correctly. Incorrect polarity may damage the Sensor.
- Never attempt to disassemble the Sensor.
- Do not use the cable harness to the other product.

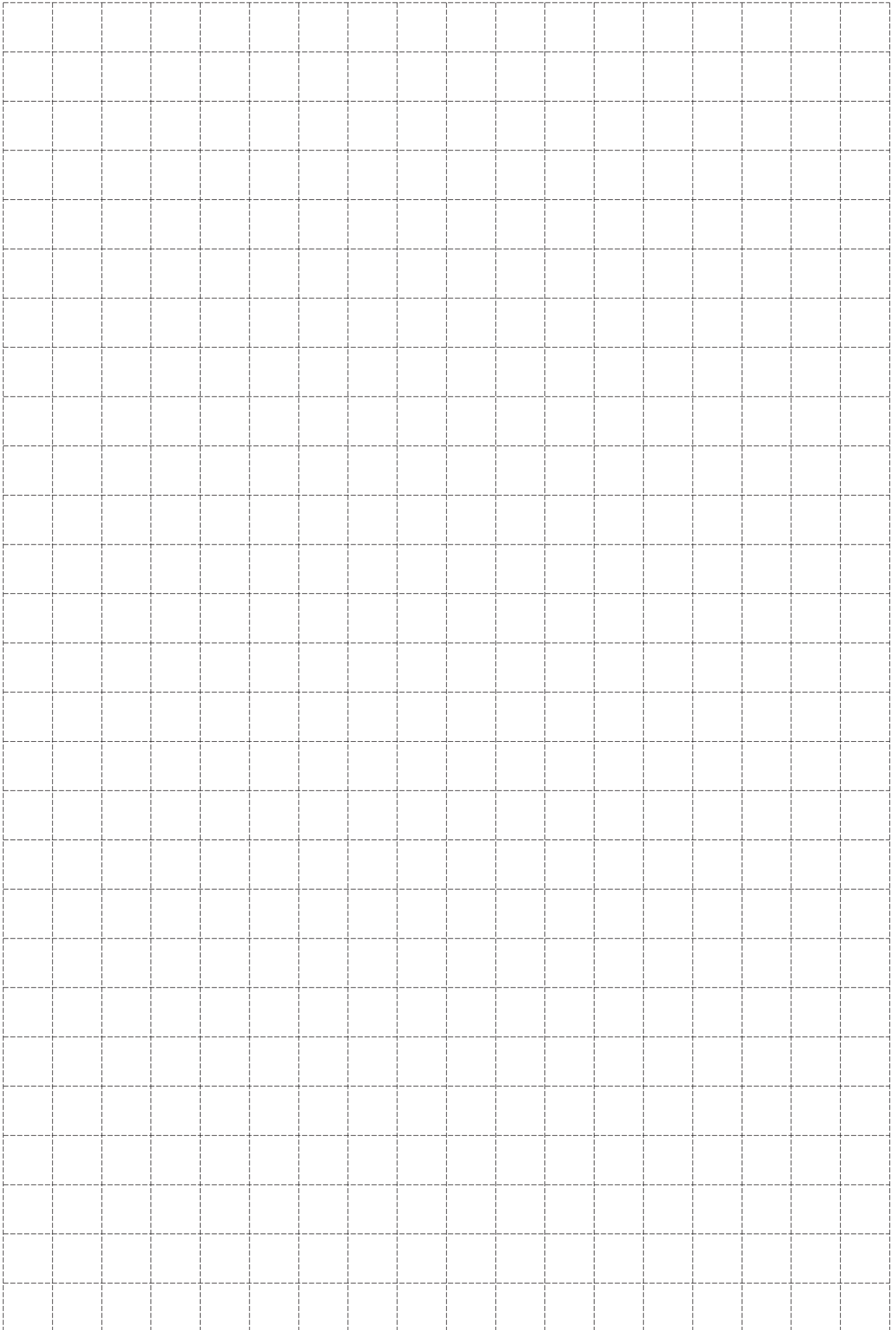

Terms and Conditions Agreement

Read and understand this catalog.

Please read and understand this catalog before purchasing the products. Please consult your OMRON representative if you have any questions or comments.

Warranties.

- (a) Exclusive Warranty. Omron's exclusive warranty is that the Products will be free from defects in materials and workmanship for a period of twelve months from the date of sale by Omron (or such other period expressed in writing by Omron). Omron disclaims all other warranties, express or implied.
- (b) Limitations. OMRON MAKES NO WARRANTY OR REPRESENTATION, EXPRESS OR IMPLIED, ABOUT NON-INFRINGEMENT, MERCHANTABILITY OR FITNESS FOR A PARTICULAR PURPOSE OF THE PRODUCTS. BUYER ACKNOWLEDGES THAT IT ALONE HAS DETERMINED THAT THE PRODUCTS WILL SUITABLY MEET THE REQUIREMENTS OF THEIR INTENDED USE.

Omron further disclaims all warranties and responsibility of any type for claims or expenses based on infringement by the Products or otherwise of any intellectual property right. (c) Buyer Remedy. Omron's sole obligation hereunder shall be, at Omron's election, to (i) replace (in the form originally shipped with Buyer responsible for labor charges for removal or replacement thereof) the non-complying Product, (ii) repair the non-complying Product, or (iii) repay or credit Buyer an amount equal to the purchase price of the non-complying Product; provided that in no event shall Omron be responsible for warranty, repair, indemnity or any other claims or expenses regarding the Products unless Omron's analysis confirms that the Products were properly handled, stored, installed and maintained and not subject to contamination, abuse, misuse or inappropriate modification. Return of any Products by Buyer must be approved in writing by Omron before shipment. Omron Companies shall not be liable for the suitability or unsuitability or the results from the use of Products in combination with any electrical or electronic components, circuits, system assemblies or any other materials or substances or environments. Any advice, recommendations or information given orally or in writing, are not to be construed as an amendment or addition to the above warranty.

See <http://www.omron.com/global/> or contact your Omron representative for published information.

Limitation on Liability; Etc.

OMRON COMPANIES SHALL NOT BE LIABLE FOR SPECIAL, INDIRECT, INCIDENTAL, OR CONSEQUENTIAL DAMAGES, LOSS OF PROFITS OR PRODUCTION OR COMMERCIAL LOSS IN ANY WAY CONNECTED WITH THE PRODUCTS, WHETHER SUCH CLAIM IS BASED IN CONTRACT, WARRANTY, NEGLIGENCE OR STRICT LIABILITY.

Further, in no event shall liability of Omron Companies exceed the individual price of the Product on which liability is asserted.

Suitability of Use.

Omron Companies shall not be responsible for conformity with any standards, codes or regulations which apply to the combination of the Product in the Buyer's application or use of the Product. At Buyer's request, Omron will provide applicable third party certification documents identifying ratings and limitations of use which apply to the Product. This information by itself is not sufficient for a complete determination of the suitability of the Product in combination with the end product, machine, system, or other application or use. Buyer shall be solely responsible for determining appropriateness of the particular Product with respect to Buyer's application, product or system. Buyer shall take application responsibility in all cases.

NEVER USE THE PRODUCT FOR AN APPLICATION INVOLVING SERIOUS RISK TO LIFE OR PROPERTY OR IN LARGE QUANTITIES WITHOUT ENSURING THAT THE SYSTEM AS A WHOLE HAS BEEN DESIGNED TO ADDRESS THE RISKS, AND THAT THE OMRON PRODUCT(S) IS PROPERLY RATED AND INSTALLED FOR THE INTENDED USE WITHIN THE OVERALL EQUIPMENT OR SYSTEM.

Programmable Products.

Omron Companies shall not be responsible for the user's programming of a programmable Product, or any consequence thereof.

Performance Data.

Data presented in Omron Company websites, catalogs and other materials is provided as a guide for the user in determining suitability and does not constitute a warranty. It may represent the result of Omron's test conditions, and the user must correlate it to actual application requirements. Actual performance is subject to the Omron's Warranty and Limitations of Liability.

Change in Specifications.

Product specifications and accessories may be changed at any time based on improvements and other reasons. It is our practice to change part numbers when published ratings or features are changed, or when significant construction changes are made. However, some specifications of the Product may be changed without any notice. When in doubt, special part numbers may be assigned to fix or establish key specifications for your application. Please consult with your Omron's representative at any time to confirm actual specifications of purchased Product.

Errors and Omissions.

Information presented by Omron Companies has been checked and is believed to be accurate; however, no responsibility is assumed for clerical, typographical or proofreading errors or omissions.

- Application examples provided in this document are for reference only. In actual applications, confirm equipment functions and safety before using the product.
- Consult your OMRON representative before using the product under conditions which are not described in the manual or applying the product to nuclear control systems, railroad systems, aviation systems, vehicles, combustion systems, medical equipment, amusement machines, safety equipment, and other systems or equipment that may have a serious influence on lives and property if used improperly. Make sure that the ratings and performance characteristics of the product provide a margin of safety for the system or equipment, and be sure to provide the system or equipment with double safety mechanisms.

OMRON Corporation

Electronic and Mechanical Components Company

Regional Contact

Americas

<https://www.components.omron.com/>

Asia-Pacific

<https://ecb.omron.com.sg/>

Korea

<https://www.omron-ecb.co.kr/>

Europe

<http://components.omron.eu/>

China

<https://www.ecb.omron.com.cn/>

Japan

<https://www.omron.co.jp/ecb/>

Mouser Electronics

Authorized Distributor

Click to View Pricing, Inventory, Delivery & Lifecycle Information:

Omron:

[D6T-44L-06](#) [D6T-8L-06](#) [D6T-HARNESS-02](#) [D6T-8L-09](#) [D6T-1A-01](#) [D6T-1A-02](#) [D6T-32L-01A](#) [D6T-44L-06H](#) [D6T-8L-09H](#)