

Slide Potentiometer

Model PSxxM / PSxxL



Features:

- Molded element
- 100,000 cycle life
- Metal or plastic shaft options
- With/without LED illumination
- With/without dust cover
- RoHS compliant

Model Styles Available

Dual Gang Without LED	PSxxM
Single Gang With LED	PSxxL

Electrical

Resistance Range, Ohms	500 -1M
Standard Resistance Tolerance	± 20%
Resistance Tapers	A,B,C
Residual Resistance	Terminals 1 to 2: Less than 10 ohms Terminals 2 to 3: Less than 30 ohms
Input Voltage, Maximum	Linear B taper: 200 Vac Other tapers: 150 Vac
Power rating, Watts (Single Unit / Dual Unit)	Linear B taper: 20mm: 0.1W / 0.05W, 30mm: 0.2W / 0.1W 45mm: 0.25W / 0.125W, 60mm: 0.2W / 0.2W Other tapers: 20mm: 0.05W / 0.025W, 30mm: 0.1W / 0.05W 45mm: 0.125W / 0.06W, 60mm: 0.1W / 0.1W
Dielectric Strength	300Vac, 1 minute
Insulation Resistance, Minimum	10M ohms at 250Vdc/ 1 minute
Sliding Noise	Less than 100mV
Gang Error	±3dB (-40dB to 0dB)

Mechanical

Static Stop Strength, Minimum	5.0 Kg/cm
Operating Force	10gf to 100gf
Detent Slip-out force	30gf to 200gf

Durability

Sliding Life	100,000 cycles
--------------	----------------

General Note

TT Electronics reserves the right to make changes in product specification without notice or liability. All information is subject to TT Electronics' own data and is considered accurate at time of going to print.

© TT electronics plc

TT Electronics | BI Technologies
413 Rood RD, Suite 7
Calexico, CA 92231
Ph: +1 714 447 2345
www.ttelectronics.com/bi-technologies

Slide Potentiometer

Model PSxxM / PSxxL



Ordering

Model PSxxM (Without LED)

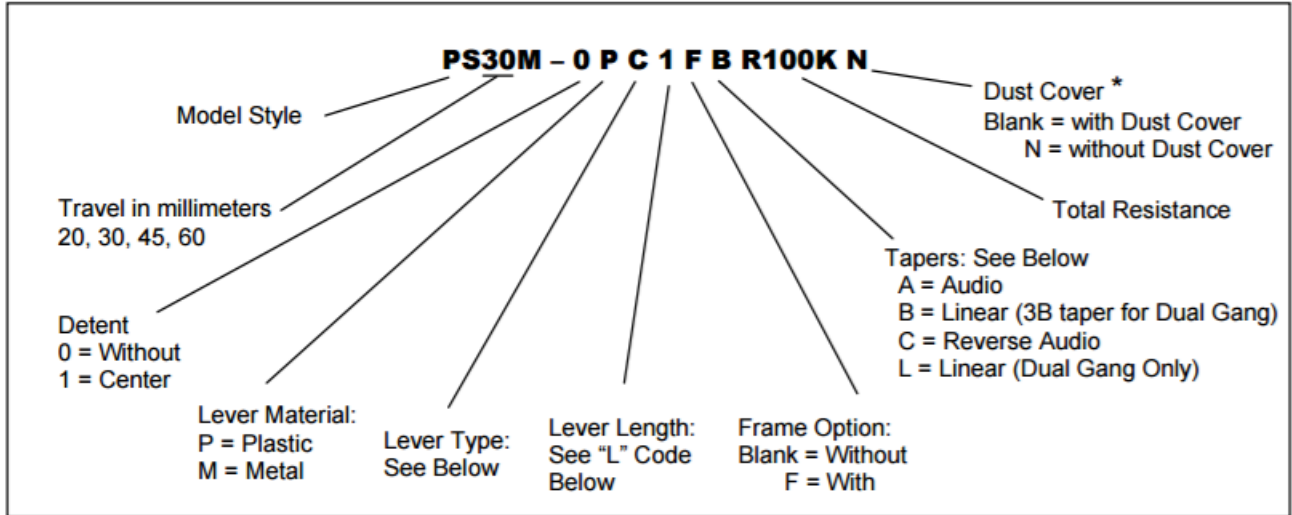

Model PSxxL (With LED)



Standard Resistance Values, ohms

500	1K	2K	5K	10K	20K	50K	100K	200K	500K	1 MEG
-----	----	----	----	-----	-----	-----	------	------	------	-------

General Note
TT Electronics reserves the right to make changes in product specification without notice or liability. All information is subject to TT Electronics' own data and is considered accurate at time of going to print.

© TT electronics plc

TT Electronics | BI Technologies
413 Rood RD, Suite 7
Calexico, CA 92231
Ph: +1 714 447 2345
www.ttelectronics.com/bi-technologies

Slide Potentiometer

Model PSxxM / PSxxL



Tapers

For Dual Gang units ONLY, the Standard Taper is a 3B taper
If Linear Taper is desired, use "L" taper option

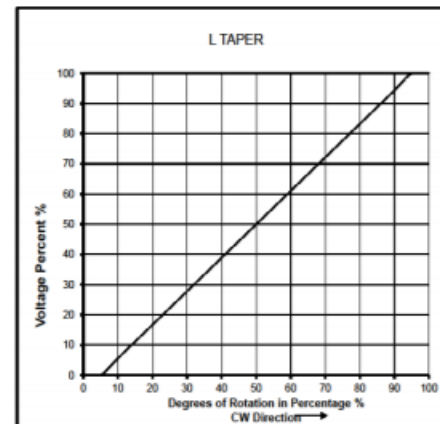
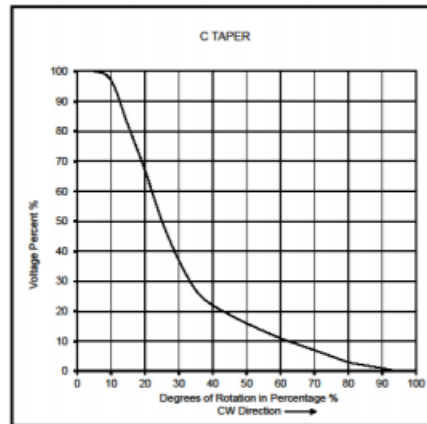
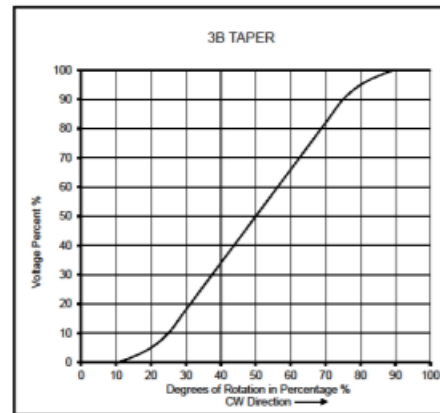
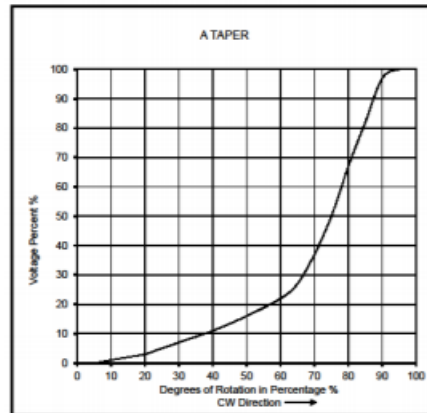

General Note

TT Electronics reserves the right to make changes in product specification without notice or liability. All information is subject to TT Electronics' own data and is considered accurate at time of going to print.

© TT electronics plc

TT Electronics | BI Technologies
413 Rood RD, Suite 7
Calexico, CA 92231
Ph: +1 714 447 2345
www.ttelectronics.com/bi-technologies

Outline Drawings

Plastic Lever Types (For PSxxM Only)

E-Type		B-Type		C-Type		D-Type		
L	5.0	L	15	L	10 15	L	10 15 20	
CODE	1	CODE	1	CODE	1 2	CODE	1 2 3	

Dust Cover option not offered for levers less than 10 mm in length

Metal Lever Types (For PSxxM Only)

D-Type				C-Type				E-Type	
L	15	20	25	F	5	10	10	L	7.6
CODE	1	2	3	CODE	1	2	3	CODE	1

* Dust Cover option not offered for levers less than 10 mm in length

Slide Potentiometer

Model PSxxM / PSxxL



Outline Drawings

Model PSxxM (Without LED)

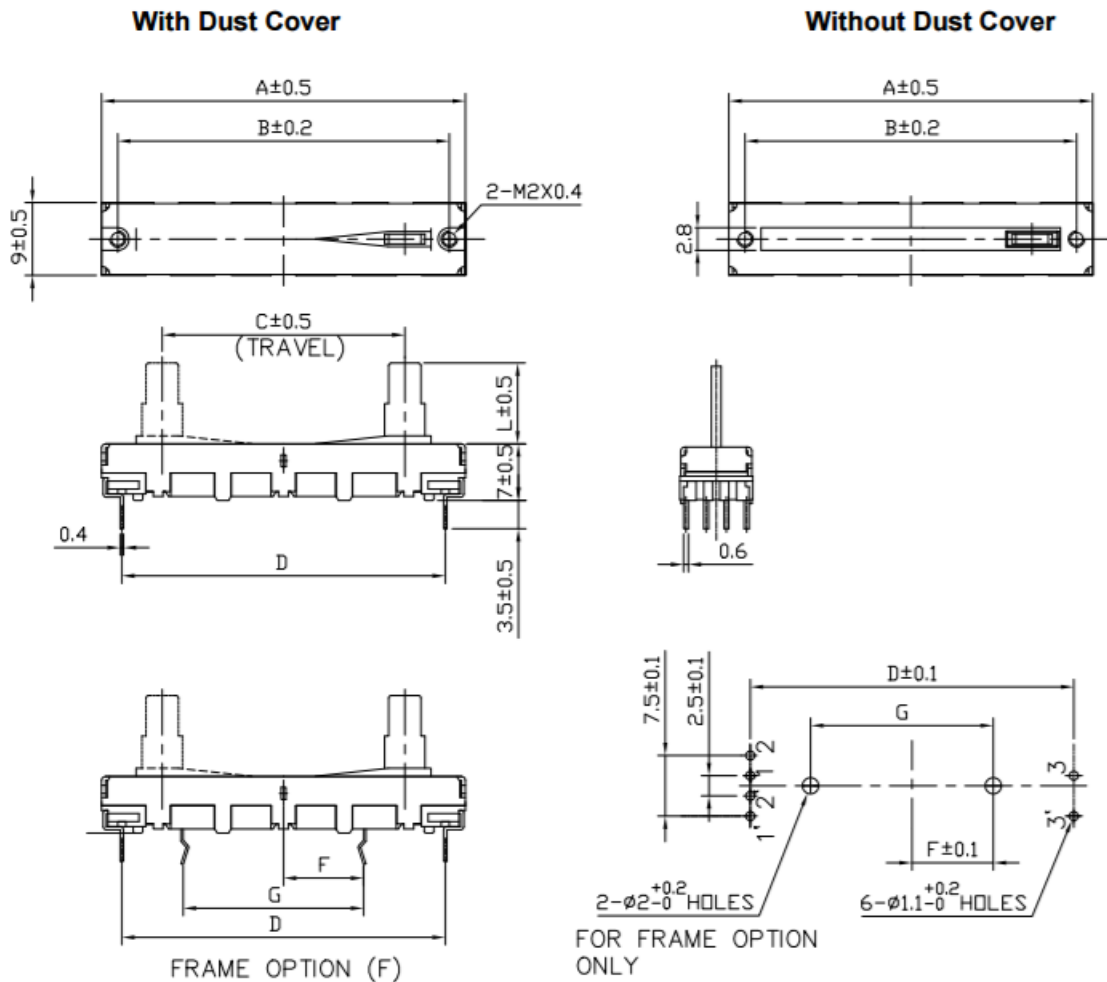

For PSxxM and PSxxL

MODEL	A	B	C	D	F	G
PS20M PS20L	35	31	20	30	5	12.5
PS30M PS30L	45	41	30	40	10	22.5
PS45M PS45L	60	56	45	55	15	32.5
PS60M PS60L	75	71	60	70	22.5	47.5

General Note
 TT Electronics reserves the right to make changes in product specification without notice or liability. All information is subject to TT Electronics' own data and is considered accurate at time of going to print.

TT Electronics | BI Technologies
 413 Rood RD, Suite 7
 Calexico, CA 92231
 Ph: +1 714 447 2345
www.ttelectronics.com/bi-technologies

Slide Potentiometer

Model PSxxM / PSxxL



Outline Drawings

Model PSxxL (With LED)

With Dust Cover



Without Dust Cover

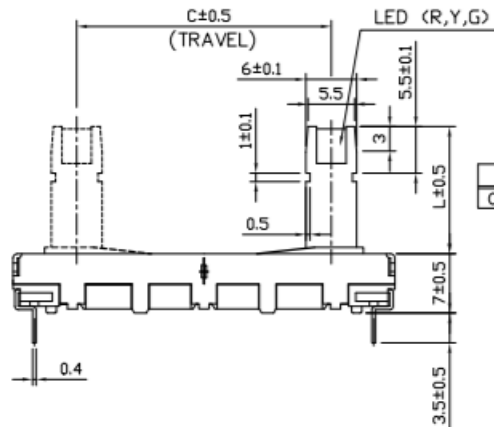

L	15	19
CODE	1	2

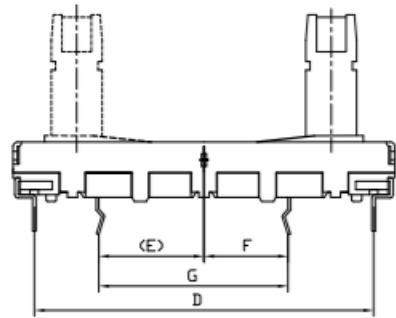

FRAME OPTION (F)

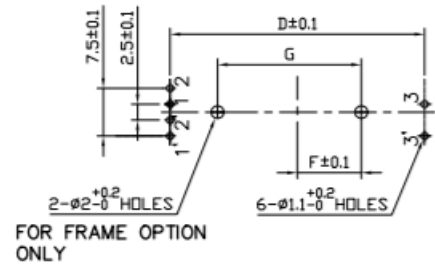

PSxxL (Single gang with LED)



PSxxM (Dual gang)

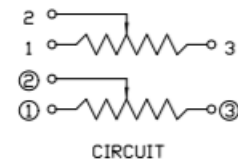

General Note
TT Electronics reserves the right to make changes in product specification without notice or liability. All information is subject to TT Electronics' own data and is considered accurate at time of going to print.

© TT electronics plc

TT Electronics | BI Technologies
413 Rood RD, Suite 7
Calexico, CA 92231
Ph: +1 714 447 2345
www.ttelectronics.com/bi-technologies

Mouser Electronics

Authorized Distributor

Click to View Pricing, Inventory, Delivery & Lifecycle Information:

TT Electronics:

[PS45L-R02BR100K](#) [PS45M-0MC2BR10K](#) [PS60M-0MC2BR100K](#) [PS45L-G02BR100K](#) [PS20M-0MC4FBR10K](#)
[PS45L-N02BR100K](#) [PS20M-0PE1FBR20K](#) [PS45M-0MC2FAR50K](#) [PS30M-0PB1FBR100K](#) [PS45M-0MC2BR10KN](#)
[PS45M-0MC2AR1K](#) [PS45L-G02AR100K](#) [PS30L-G11BR1K](#) [PS45L-N01FBR100KN](#) [PS20M-0MC2FBR20K](#) [PS45L-](#)
[R02AR1MEG](#) [PS60M-0MC2FBR20K](#) [PS45L-R02BR10KN](#) [PS45L-N02BR10K](#) [PS45L-N02AR1MEG](#) [PS30L-](#)
[R01BR1K](#) [PS30M-0PC1FBR10K](#) [PS45M-0MC2AR5K](#) [PS45L-G02BR1K](#) [PS45L-R02BR10K](#) [PS20M-020A](#) [PS45M-](#)
[1PD2FLR10KN](#) [PS60M-0MC2FBR10K](#) [PS60M-0MC2BR10K](#) [PS20L-N02FBR10KN](#) [PS45L-11PC3BR10K](#) [PS20M-](#)
[0MC2FBR10K](#) [PS45M-0ME1BR100K](#) [PS30L-R01BR20KN](#) [PS45M-0ME1BR10K](#) [PS60M-0ME1BR50K](#) [PS30M-](#)
[OPC1FBR10K](#) [PS45M-0MC2LR10K](#) [PS20M-0PC1FAR250KN](#) [PS60M-0MC1BR10K](#) [PS60M-0ME1BR100K](#) [PS45M-](#)
[0MD2LR20K](#) [PS60M-0MC1BR50K](#) [PS45L-R01FBR100KN](#) [PS60L-N01FBR50K](#) [PS45M-0MC1BR100K](#) [PS45M-](#)
[1PD2FB10K](#) [PS45M-0MC1BR1MEG](#) [PS20L-R01FAR100K](#) [PS20M-0ME1FAR10KN](#) [PS60M-0MC1BR500](#) [PS45L-](#)
[R01FB100K](#) [PS45L-R02AR100K](#) [PS30L-N12FBR10K](#) [PS45L-Y01BR50K](#) [PS60M-0ME1BR500K](#) [PS20L-G01AR100K](#)
[PS45M-1MD2LR10K](#) [PS45L-R02BR1K](#) [PS60M-0MC1BR5K](#) [PS20M-1MD1FBR20K](#) [PS45M-1PD2FBR10KN](#)
[PS20M-0PB1FAR500](#) [PS45M-0ME1BR50K](#) [PS20M-0PB1FAR500N](#) [PS45M-0MC1BR500K](#) [PS30L-R01AR500K](#)
[PS45M-OPE1FBR100KN](#) [PS45M-1MD2LR20K](#) [PS60M-0MC1BR100K](#) [PS20L-R01FBR10K](#) [PS45M-0PE1FBR100KN](#)
[PS30L-G02FBR50KN](#) [PS20M-1PD2BR10K](#) [PS20M-1PD2FBR10K](#) [PS60M-0ME1BR10K](#) [PS45M-0MC1BR10K](#)
[PS45M-0MC1FBR10K](#) [PS20M-0MC1LR10K](#) [PS45M-0ME1BR1K](#) [PS45L-Y02BR100K](#) [PS20M-0MC1BR10K](#) [PS20L-](#)
[G01BR10K](#) [PS60M-0MD1AR20K](#) [PS45M-0MC1BR50K](#) [PS20M-1MC1B50K](#) [PS60M-0ME1BR1MEG](#) [PS45L-](#)
[R01FAR50KN](#) [PS20M-0PC1FR100K](#) [PS45M-0MD1FBR10KN](#) [PS20M-0PC1FBR100K](#) [PS45M-0MC1BR1K](#) [PS60M-](#)
[0ME1BR500](#) [PS45M-0MC3BR10K](#) [PS45M-0PD1FBR10KN](#) [PS45L-N02BR1K](#) [PS60M-1MC2FBR20K](#) [PS45M-](#)
[0MC2LR10KN](#) [PS60M-0MC2AR1MEG](#) [PS20L-R01BR100K](#)