

# E3Z-LT/LR/LL

## Compact and Reliable Laser Photoelectric Sensor

- Safety and reliability with laser class 1 (JIS and IEC).
- Product lineup includes models with distance setting without influence of color.
- Maximum ambient operating temperature of 55°C and water-proof construction in E3Z class.



 Be sure to read *Safety Precautions* on page 9.

## Applications

Detect the sides of large tiles.

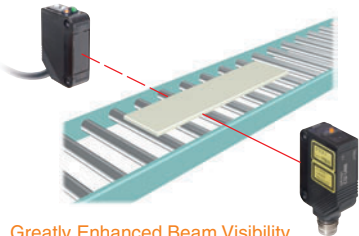

Greatly Enhanced Beam Visibility for Easier Optical Axis Adjustment of Sensors

Count bottles.

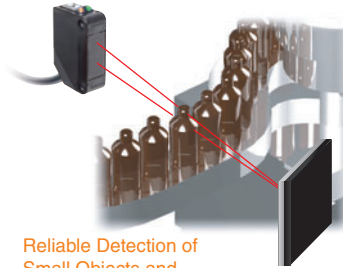

Reliable Detection of Small Objects and Narrow Gaps with the Small Spot

Detect chip components on tape.

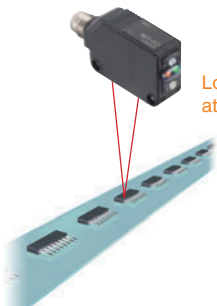

Long-distance Sensing at 300 mm (White Paper)

Detect protruding straws.

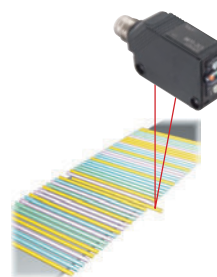





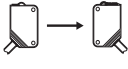

A Low Black/White Error for Applications with Mixed Colors

## Ordering Information

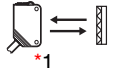
### Sensors (Refer to Dimensions on page 11.)

 Red light

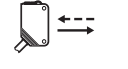
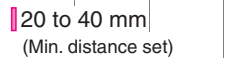
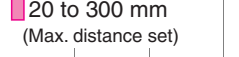
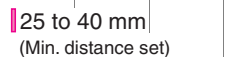
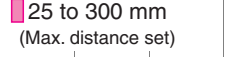
Sensing method	Appearance	Connection method	Response time	Sensing distance	Model					
					NPN output	PNP output				
Through-beam (Emitter + Receiver) *4		Pre-wired (2 m)*3	1 ms	 60 m	E3Z-LT61 2M Emitter E3Z-T61-L 2M Receiver E3Z-T61-D 2M	E3Z-LT81 2M Emitter E3Z-T81-L 2M Receiver E3Z-T81-D 2M				
		Connector (M8, 4 pins)					E3Z-LT66 Emitter E3Z-T66-L Receiver E3Z-T66-D	E3Z-LT86 Emitter E3Z-T86-L Receiver E3Z-T86-D		
Retro-reflective with MSR function		Pre-wired (2 m)*3		*2	 15 m (300 mm) (Using E39-R1)	E3Z-LR61 2M	E3Z-LR81 2M			
		Connector (M8, 4 pins)						 7 m (200 mm) (Using E39-R12)	E3Z-LR66	E3Z-LR86
								 7 m (200 mm) (Using E39-R6)		
Distance-settable (BGS Models)		Pre-wired (2 m)*3		0.5 ms	 20 to 40 mm (Min. distance set)	E3Z-LL61 2M	E3Z-LL81 2M			
		Connector (M8, 4 pins)	 20 to 300 mm (Max. distance set)					E3Z-LL66	E3Z-LL86	
		Pre-wired (2 m)*3			 25 to 40 mm (Min. distance set)	E3Z-LL63 2M	E3Z-LL83 2M			
		Connector (M8, 4 pins)	 25 to 300 mm (Max. distance set)					E3Z-LL68	E3Z-LL88	

\*1. The Reflector is sold separately. Select the Reflector model most suited to the application.

\*2. Values in parentheses indicate the minimum required distance between the Sensor and Reflector.

\*3. Pre-wired Models with a 0.5-m cable are also available for these products. When ordering, specify the cable length by adding "0.5M" to the end of the model number (e.g., E3Z-LT61 0.5M).

M12 Pre-wired Connector Models are also available. When ordering, add "-M1J" to the end of the model number (e.g., E3Z-LT61-M1J). The cable is 0.3 m long.

Also, the following connection forms can be manufactured. Ask your OMRON representative for details.

- Pre-wired Models with 1-m or 5-m cables
- Pre-wired Connector Models with M8 4-pin connectors or M8 3-pin connectors.

\*4. Through-beam Sensors are normally sold in sets that include both the Emitter and Receiver.

Orders for individual Emitters and Receivers are accepted. (Modifications are required for some models. Ask your OMRON representative for details.)

## Accessories









**Slits** (A Slit is not provided with a Through-beam Sensor. Order a Slit separately if required.) (Refer to Dimensions on page 14.)

Slit width	Sensing distance	Minimum detectable object (typical)	Model	Contents
0.5 mm dia.	3 m	0.1 mm dia.	E39-S65A	One set (contains Slits for both the Emitter and Receiver)

**Reflectors** (A Reflector is required for Retro-reflective Sensors: A Reflector is not provided with the Sensor. Be sure to order a Reflector.) (Refer to Dimensions on page 14.)

Name	Sensing distance (typical)	Model	Remarks
Reflector	15 m (300 mm)	E39-R1	<ul style="list-style-type: none"> <li>• Retro-reflective models are not provided with Reflectors.</li> <li>• Separate the Sensor and the Reflector by at least the distance given in parentheses.</li> <li>• The MSR function is enabled.</li> </ul>
	7 m (200 mm)	E39-R12	
	7 m (200 mm)	E39-R6	





**Mounting Brackets** A Mounting Bracket is not provided with the Sensor. Order a Mounting Bracket separately if required.  
 (Refer to *Dimensions* on E39-L/F39-L/E39-S/E39-R.)

Appearance	Model	Quantity	Remarks	Appearance	Model	Quantity	Remarks
	E39-L153	1	Mounting Brackets		E39-L98	1	Metal Protective Cover Bracket *
	E39-L104	1			E39-L150	1 set	(Sensor adjuster)
	E39-L43	1	Horizontal Mounting Bracket *		E39-L151	1 set	Easily mounted to the aluminum frame rails of conveyors and easily adjusted. For left to right adjustment
	E39-L142	1	Horizontal Protective Cover Bracket *				
	E39-L44	1	Rear Mounting Bracket		E39-L144	1	Compact Protective Cover Bracket (For E3Z only) *

Note: When using a Through-beam Sensor, order one Mounting Bracket for the Receiver and one for the Emitter  
 \* Cannot be used for Standard Connector models.

### Sensor I/O Connectors

(Models for Connectors and Pre-wired Connectors: A Connector is not provided with the Sensor. Be sure to order a Connector separately.)  
 (Refer to *Dimensions* on XS3, XS2)

Size	Cable	Appearance	Cable type	Model	
M8	Standard	Straight *1 	2 m	4-wire	XS3F-M421-402-A
			5 m		XS3F-M421-405-A
		L-shaped *1 *2 	2 m	4-wire	XS3F-M422-402-A
			5 m		XS3F-M422-405-A
M12 (For -M1J models)	Standard	Straight *1 	2 m	3-wire	XS2F-D421-DC0-A
			5 m		XS2F-D421-GC0-A
		L-shaped *1 	2 m	3-wire	XS2F-D422-DC0-A
			5 m		XS2F-D422-GC0-A

Note: When using a Through-beam Sensor, order one Mounting Bracket for the Receiver and one for the Emitter  
 \*1. The connector will not rotate after connecting.  
 \*2. The cable is fixed at an angle of 180° from the sensor emitter/receiver surface.

## Ratings and Specifications

Sensing method		Through-beam	Retro-reflective with MSR function	Distance-settable (BGS models)	
Response		Standard response			High-speed response
Item	Model	E3Z-LT61/-LT66	E3Z-LR61/-LR66	E3Z-LL61/-LL66	E3Z-LL63/-LL68
	NPN output	E3Z-LT81/-LT86	E3Z-LR81/-LR86	E3Z-LL81/-LL86	E3Z-LL83/-LL88
Sensing distance		60 m	0.3 to 15 m (when using E39-R1) 0.2 to 7 m (when using E39-R12) 0.2 to 7 m (when using E39-R6)	White paper (100 × 100 mm): 20 to 300 mm Black paper (100 × 100 mm): 20 to 160 mm	White paper (100 × 100 mm): 25 to 300 mm Black paper (100 × 100 mm): 25 to 100 mm
Set distance range		---		White paper (100 × 100 mm): 40 to 300 mm Black paper (100 × 100 mm): 40 to 160 mm	White paper (100 × 100 mm): 40 to 300 mm Black paper (100 × 100 mm): 40 to 100 mm
Spot diameter (typical)		5-mm dia. at 3 m		0.5-mm dia. at 300 mm	
Standard sensing object		Opaque: 12-mm dia. min.	Opaque: 75-mm dia. min.	---	
Minimum detectable object (typical)		6-mm-dia. opaque object at 3 m		0.2-mm-dia. stainless-steel pin gauge at 300 mm	
Differential travel		---		5% max. of set distance	
Black/white error		---		5% at 160 mm	5% at 100 mm
Directional angle		Receiver: 3 to 15°	---		
Light source (wavelength)		Red LD (655 nm), JIS Class 1, IEC Class 1, FDA Class II			
Power supply voltage		12 to 24 VDC±10%, ripple (p-p): 10% max.			
Current consumption		35 mA (Emitter 15 mA, Receiver 20 mA)	30 mA max.		
Control output		Load power supply voltage: 26.4 VDC max., Load current: 100 mA max., Open collector output			
Residual output voltage		Load current of less than 10 mA: 1 V max. Load current of 10 to 100 mA: 2 V max.			
Output mode switching		Switch to change between light-ON and dark-ON			
Protection circuits		Reversed power supply polarity protection, Output short-circuit protection, and Reversed output polarity protection	Reversed power supply polarity protection, Output short-circuit protection, Mutual interference prevention, and Reversed output polarity protection		
Response time		Operate or reset: 1 ms max.			Operate or reset: 0.5 ms max.
Sensitivity adjustment		One-turn adjuster		Five-turn endless adjuster	
Ambient illumination (Receiver side)		Incandescent lamp: 3,000 lx max. Sunlight: 10,000 lx max.			
Ambient temperature range		Operating: -10 to 55°C, Storage: -25 to 70°C (with no icing or condensation)			
Ambient humidity range		Operating: 35% to 85%, Storage: 35% to 95% (with no icing or condensation)			
Insulation resistance		20 MΩ min. at 500 VDC			
Dielectric strength		1,000 VAC, 50/60 Hz for 1 min			
Vibration resistance		Destruction: 10 to 55 Hz, 1.5-mm double amplitude for 2 hours each in X, Y, and Z directions			
Shock resistance		Destruction: 500 m/s <sup>2</sup> 3 times each in X, Y, and Z directions			
Degree of protection		IP67 (IEC 60529)			
Connection method		Pre-wired cable (standard length: 2 m): Standard M8 Connector:	E3Z-L□□1/-L□□3 E3Z-L□□6/-L□□8		
Indicator		Operation indicator (orange) Stability indicator (green) Emitter for Through-beam Models has power indicator (orange) only.			
Weight (packed state)	Pre-wired cable (2 m)	Approx. 120 g	Approx. 65 g		
	Standard Connector	Approx. 30 g	Approx. 20 g		
Material	Case	PBT (polybutylene terephthalate)			
	Lens	Modified polyarylate resin	Methacrylic resin	Modified polyarylate resin	
Accessories		Instruction manual (Neither Reflectors nor Mounting Brackets are provided with any of the above models.)			

Engineering Data (Typical)

Parallel Operating Range

Through-beam Models

E3Z-LT□□

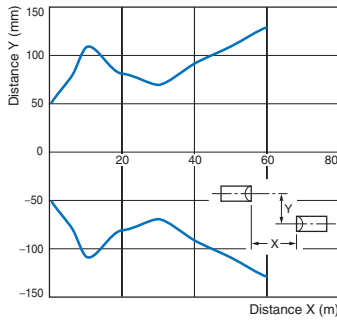

Through-beam Models

E3Z-LT□□ + E39-S65A

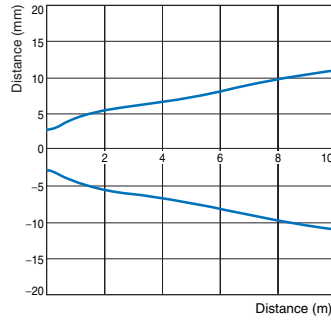

Retro-reflective Models

E3Z-LR□□

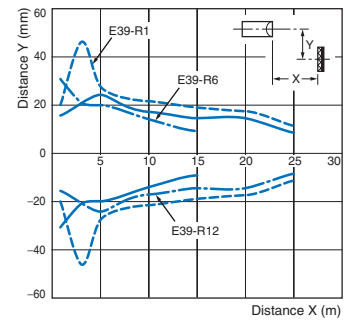

Operating Range at a Set Distance of 300 mm

BGS Models

E3Z-LL□□

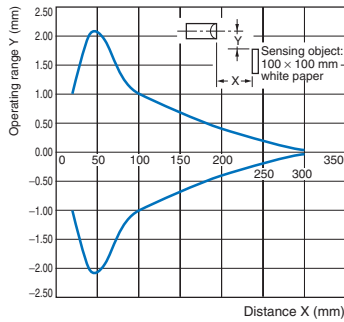

Operating Range at a Set Distance of 40 mm

BGS Models

E3Z-LL□□

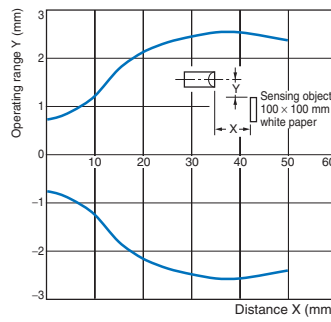

Excess Gain vs. Set Distance

Through-beam Models

E3Z-LT□□

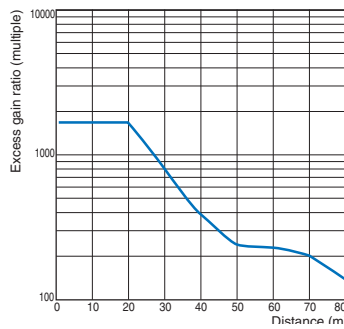

Retro-reflective Models

E3Z-LR□□

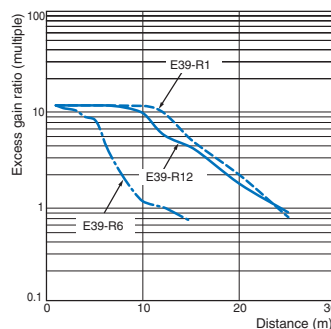

Close Range Characteristics

BGS Models

E3Z-LL□1/LL□6

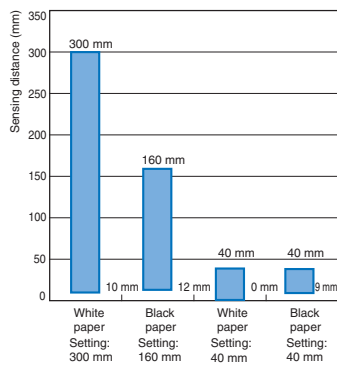

E3Z-LL□3/LL□8

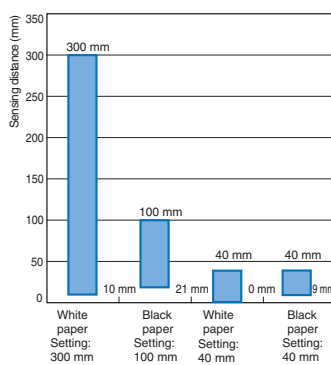

## Sensing Distance vs. Sensing Object Material

### BGS Models

#### E3Z-LL□1/-LL□6

White Paper with a Set Distance of 40 mm

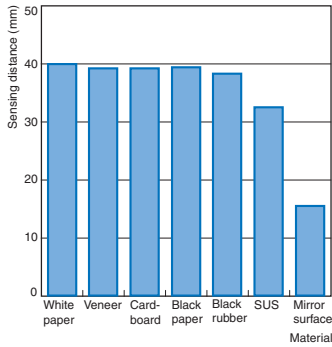

#### E3Z-LL□3/-LL□8

White Paper with a Set Distance of 40 mm

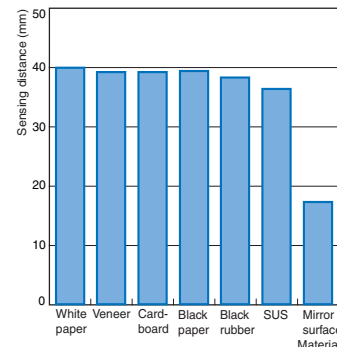

#### E3Z-LL□1/-LL□6

White Paper with a Set Distance of 300 mm

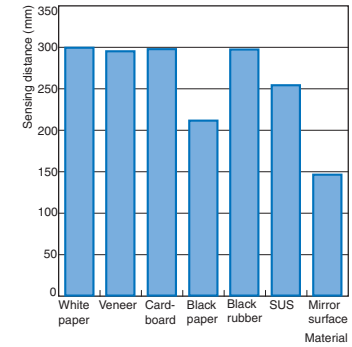

#### E3Z-LL□3/-LL□8

White Paper with a Set Distance of 100 mm

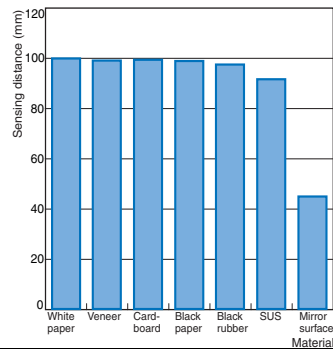

## Emission Spot Diameter vs. Distance

Through-beam and Retro-reflective Models (Same for All Models)

### E3Z-LT□□, E3Z-LR□□

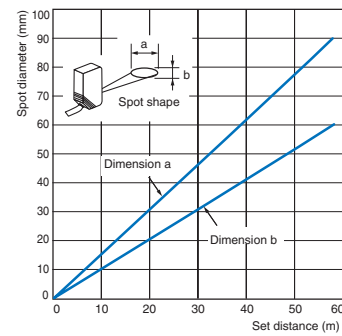

BGS Models (Same for All Models)

### E3Z-LL□□

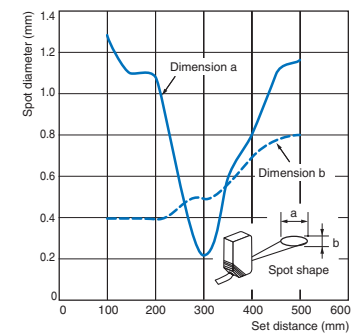

## Hysteresis vs. Distance

### BGS Models

#### E3Z-LL□1 (LL□6)

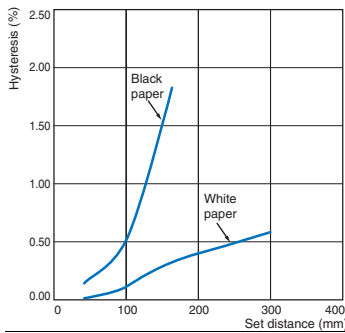

#### E3Z-LL□3 (LL□8)

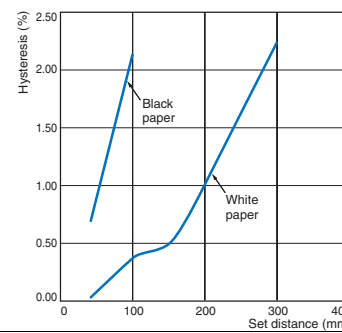

## Inclination Characteristics (Vertical)

### BGS Models

#### E3Z-LL□□

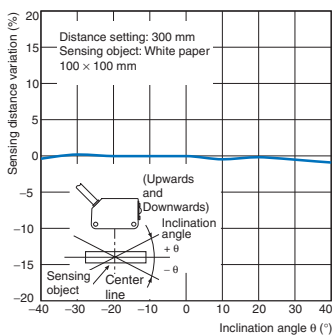

## Inclination Characteristics (Horizontal)

### BGS Models

#### E3Z-LL□□

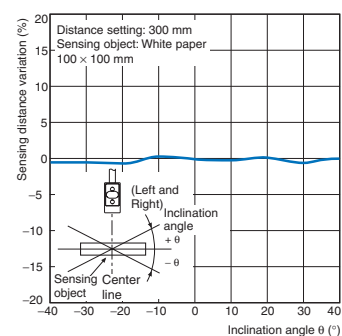

## I/O Circuit Diagrams

### NPN Output

Model	Operation mode	Timing charts	Operation selector	Output circuit
E3Z-LT61 * E3Z-LT66 * E3Z-LR61 E3Z-LR66	Light-ON		L side (LIGHT ON)	
	Dark-ON		D side (DARK ON)	
E3Z-LL61 E3Z-LL66 E3Z-LL63 E3Z-LL68	Light-ON		L side (LIGHT ON)	
	Dark-ON		D side (DARK ON)	

### PNP Output

Model	Operation mode	Timing charts	Operation selector	Output circuit
E3Z-LT81 * E3Z-LT86 * E3Z-LR81 E3Z-LR86	Light-ON		L side (LIGHT ON)	
	Dark-ON		D side (DARK ON)	
E3Z-LL81 E3Z-LL86 E3Z-LL83 E3Z-LL88	Light-ON		L side (LIGHT ON)	
	Dark-ON		D side (DARK ON)	

\* Models numbers for Through-beam Sensors (E3Z-LT□□) are for sets that include both the Emitter and Receiver. The model number of the Emitter is expressed by adding "-L" to the set model number (example: E3Z-LT61-L 2M), the model number of the Receiver, by adding "-D" (example: E3Z-LT61-D 2M). Refer to Ordering Information to confirm model numbers for Emitter and Receivers.

## Plugs (Sensor I/O Connectors)

### M8 4-pin Connectors

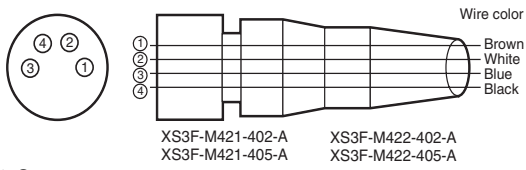

### M12 Connectors

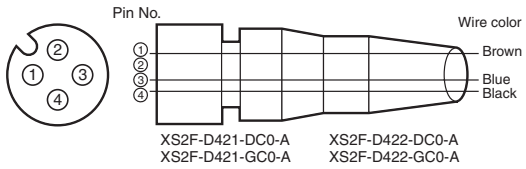

## Nomenclature

### Sensors with Sensitivity Adjustment and Mode Selector Switch

#### Through-beam Models

E3Z-LT□□ (Receiver)

#### Retro-reflective Models

E3Z-LR□□



### Distance-settable Sensor

#### BGS Models

E3Z-LL□□

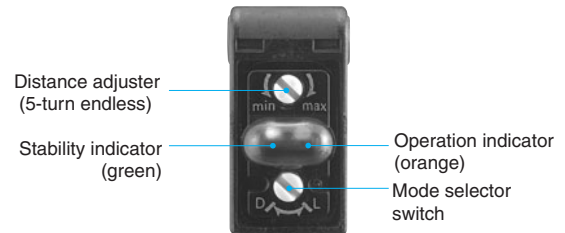



## Safety Precautions

Refer to *Warranty and Limitations of Liability*.

### WARNING

This product is not designed or rated for ensuring safety of persons. Do not use it for such purpose.



To ensure safe use of laser products, do not allow the laser beam to enter your eye. Direct exposure may adversely affect your eyesight.



### CAUTION

Do not connect an AC power supply to the Sensor. If AC power (100 VAC or more) is supplied to the Sensor, it may explode or burn.



## Precautions for Safe Use

Be sure to abide by the following precautions for the safe operation of the Sensor.

### ● Operating Environment

Do not use the Sensor in locations with explosive or flammable gas.

### ● Wiring

#### Power Supply Voltage and Output Load Power Supply Voltage

Make sure that the power supply to the Sensor is within the rated voltage range. If a voltage exceeding the rated voltage range is supplied to the Sensor, it may explode or burn.

#### Power Supply Voltage

The maximum power supply voltage is 26.4 VDC. Applying a voltage exceeding the rated range may damage the Sensor or cause burning.

#### Load

Do not use a load that exceeds the rated load.

#### Load Short-circuiting

Do not short-circuit the load, otherwise the Sensor may be damaged or it may burn.

#### Connection without Load

Do not connect the power supply to the Sensor with no load connected, otherwise the internal elements may explode or burn. Always connect a load when wiring.

## Precautions for Correct Use

Do not use the product in atmospheres or environments that exceed product ratings.

### ● Laser Warning Labels

Be sure that the correct laser warning label (enclosed) is attached for the country of intended use of the equipment containing the Photoelectric Sensor. Refer to the user's manual for details.

### ● Usage Environment

#### Water Resistance

The Sensor is rated IP67. Do not use it in water, in the rain, or outdoors.

#### Ambient Environment

Do not install the product in the following locations. Doing so may result in product failure or malfunction.

- Locations subject to excess dust and dirt
- Locations subject to direct sunlight
- Locations subject to corrosive gas
- Locations subject to organic solvents
- Locations subject to shock or vibration
- Locations subject to exposure to water, oil, or chemicals
- Locations subject to high humidity or condensation

### ● Designing

#### Power Reset Time

The Sensor is ready to operate 100 ms after the Sensor is turned ON. If the load and Sensor are connected to independent power supplies respectively, be sure to turn ON the Sensor before supplying power to the load.

### ● Wiring

#### Avoiding Malfunctions

If using the Sensor with an inverter or servomotor, always ground the FG (frame ground) and G (ground) terminals, otherwise the Sensor may malfunction.

### ● Mounting

#### Mounting the Sensor

- If Sensors are mounted face-to-face, make sure that the optical axes are not in opposition to each other. Otherwise, mutual interference may result.
- Always install the Sensor carefully so that the aperture angle range of the Sensor will not cause it to be directly exposed to intensive light, such as sunlight, fluorescent light, or incandescent light.
- Do not strike the Photoelectric Sensor with a hammer or any other tool during the installation of the Sensor, or the Sensor will lose its water-resistive properties.
- Use M3 screws to mount the Sensor.
- When mounting the case, make sure that the tightening torque applied to each screw does not exceed 0.54 N·m.

#### Metal Connectors

- Always turn OFF the power supply to the Sensor before connecting or disconnecting the metal connector.
- Hold the connector cover to connect or disconnect it. If the XS3F is used, always tighten the connector cover by hand. Do not use pliers. If the tightening is insufficient, the degree of protection will not be maintained and the Sensor may become loose due to vibration. The appropriate tightening torque is 0.3 to 0.4 N·m. If other commercially available connectors are used, follow the recommended connector application conditions and recommended tightening torque specifications.

## Mounting Direction for Distance-settable Models

- Make sure that the sensing side of the Sensor is parallel with the surface of the sensing objects. Normally, do not incline the Sensor towards the sensing object.

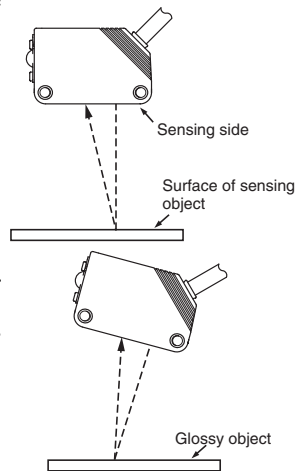

If the sensing object has a glossy surface, however, incline the Sensor by 5° to 10° as shown in the illustration, provided that the Sensor is not influenced by background objects.

- If there is a mirror-like object below the Sensor, the Sensor may not operate stably. Therefore, incline the Sensor or separate the Sensor from the mirror-like object as shown below.

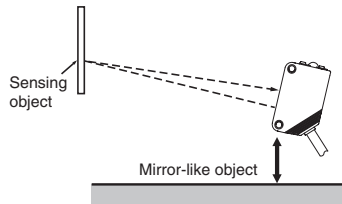

- Do not install the Sensor in the wrong direction. Refer to the following illustration.

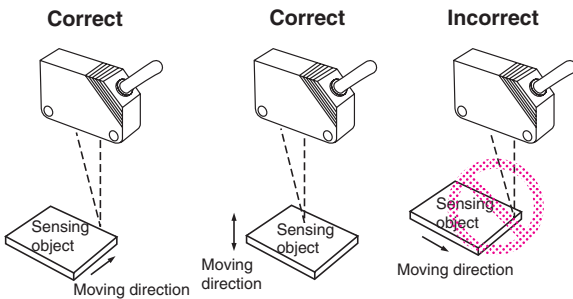

Install the Sensor as shown in the following illustration if each sensing object greatly differs in color or material.

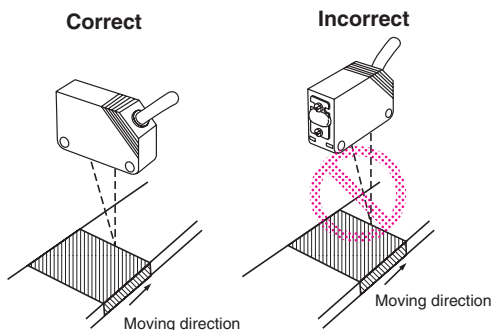

- The stability indicator may turn off in reaction to reflection from background objects. In such cases, incline the Sensor by 10° as shown in the illustration for more stable detection.

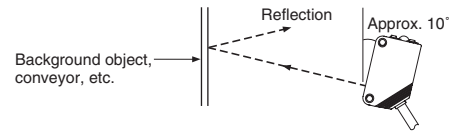

## Adjusting Distance-settable Models Indicator Operation

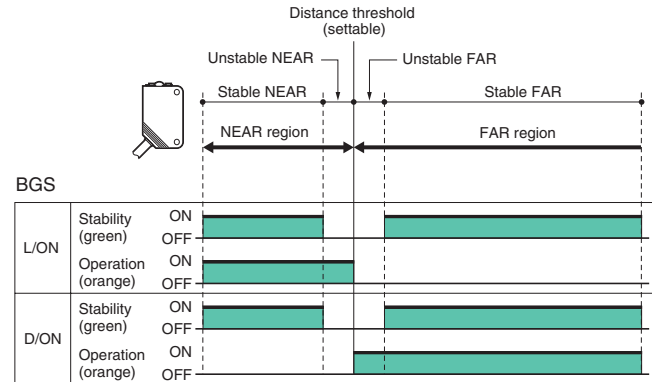

Note: If the stability indicator is lit, the detection/no detection status is stable within the rated ambient operating temperature (-10 to 55°C).

## Inspection and Maintenance Cleaning

Never use paint thinners or other organic solvents to clean the surface of the product.

## Dimensions

### Sensors

#### Through-beam \* Pre-wired Models E3Z-LT61 E3Z-LT81

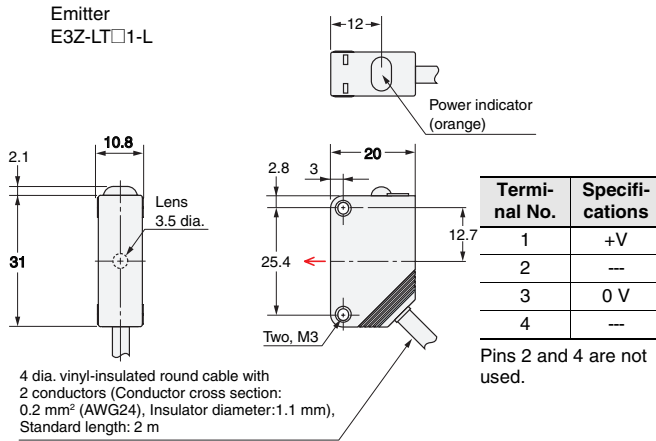

#### M12 Pre-wired Connector (E3Z-LT□□-M1J)

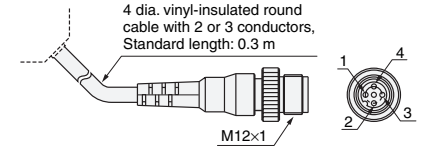

#### Pre-wired Connector Models with M8 connectors (Inquire)

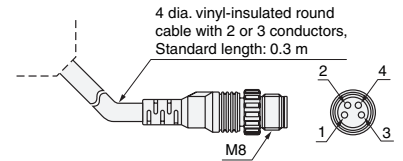

#### Pre-wired Connector Models with M8 3-pin connectors (Inquire)

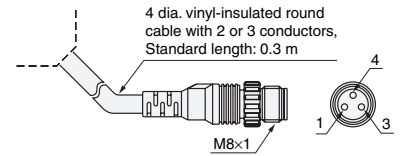

\* The Emitter cable has two conductors and the Receiver cable has three conductors.

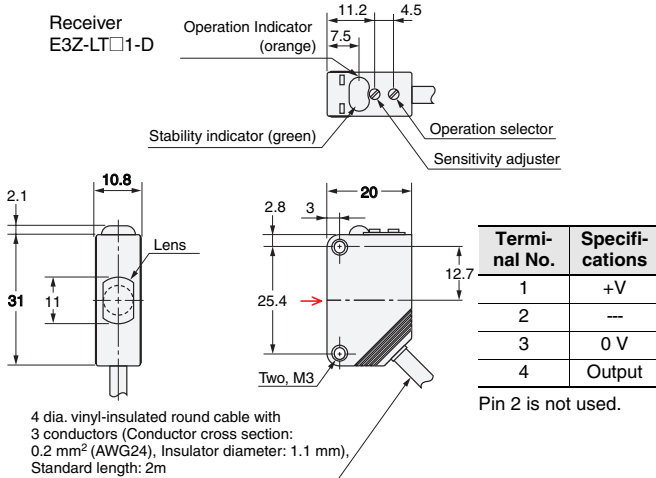

#### Through-beam \* Standard Connector Models E3Z-LT66 E3Z-LT86

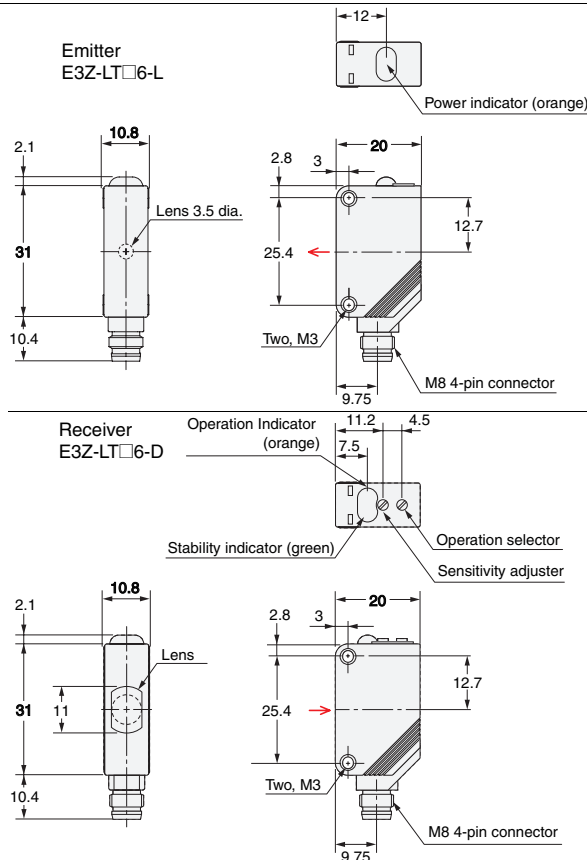

\* Models numbers for Through-beam Sensors (E3Z-LT□□) are for sets that include both the Emitter and Receiver. The model number of the Emitter is expressed by adding "-L" to the set model number (example: E3Z-LT61-L 2M), the model number of the Receiver, by adding "-D" (example: E3Z-LT61-D 2M.) Refer to Ordering Information to confirm model numbers for Emitter and Receivers.

## Retro-reflective Models

### Pre-wired Models

E3Z-LR61

E3Z-LR81

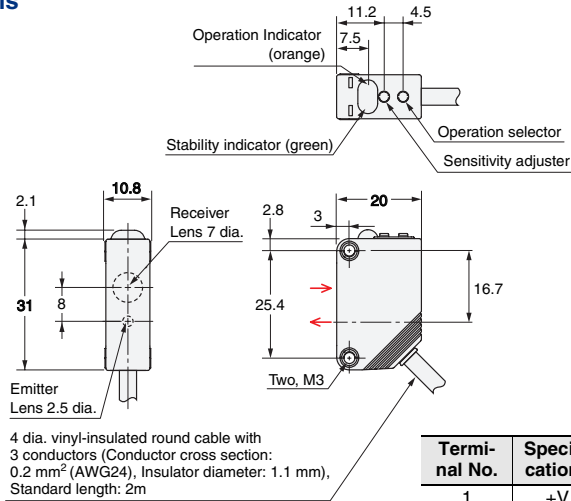

Terminal No.	Specifications
1	+V
2	---
3	0 V
4	Output

### M12 Pre-wired Connector (E3Z-LR□□-M1J)

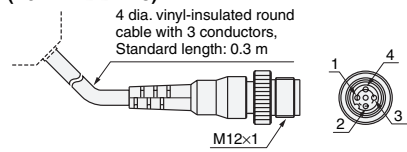

### Pre-wired Connector Models with M8 connectors (Inquire)

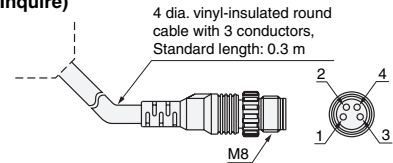

### Pre-wired Connector Models with M8 3-pin connectors (Inquire)

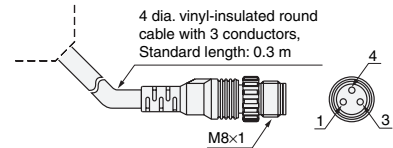

## Retro-reflective Models

### Standard Connector Models

E3Z-LR66

E3Z-LR86

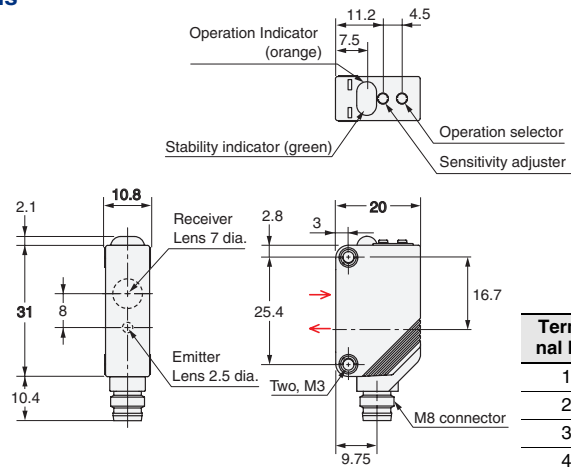

Terminal No.	Specifications
1	+V
2	---
3	0 V
4	Output

## BGS Models

### Pre-wired Models

E3Z-LL61

E3Z-LL81

E3Z-LL63

E3Z-LL83

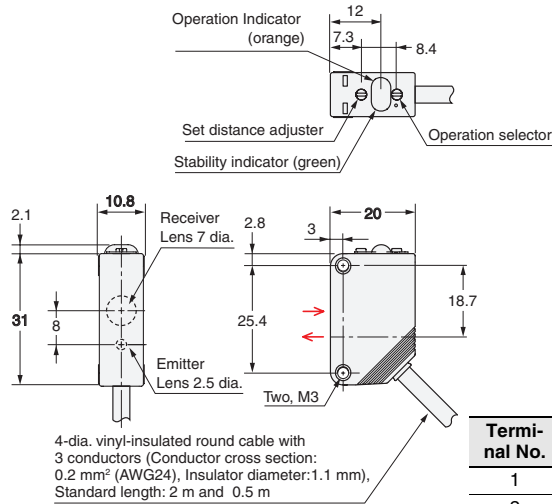

Terminal No.	Specifications
1	+V
2	---
3	0 V
4	Output

### M12 Pre-wired Connector (E3Z-LL□□-M1J)

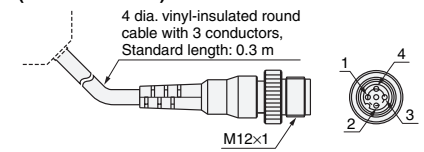

### Pre-wired Connector Models with M8 connectors (Inquire)

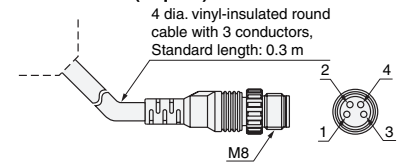

### Pre-wired Connector Models with M8 3-pin connectors (Inquire)

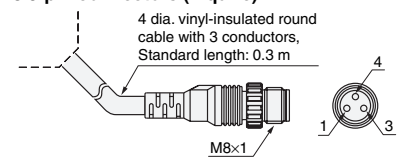

## BGS Models

### Standard M8

### Connector Models

E3Z-LL66

E3Z-LL86

E3Z-LL68

E3Z-LL88

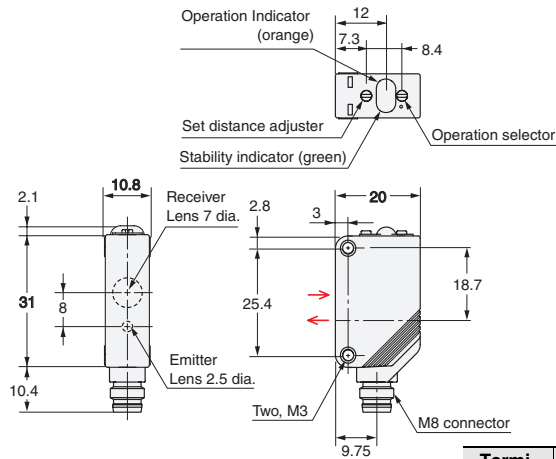

Terminal No.	Specifications
1	+V
2	---
3	0 V
4	Output

## Accessories (Order Separately)

### Slit E39-S65A



Material  
SUS301 stainless steel

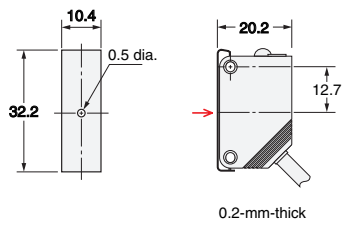

### Reflector E39-R1



Materials  
Reflective surface: Acrylic  
Rear surface: ABS

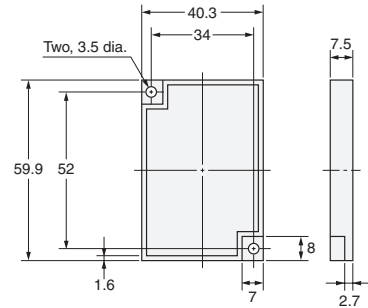

### Reflector E39-R6



Materials  
Reflective surface: Acrylic  
Rear surface: ABS

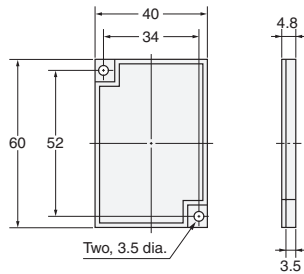

### Reflector E39-R12



Materials  
Reflector: Polycarbonate (surface)  
Acrylic (interior)  
Frame: ABS

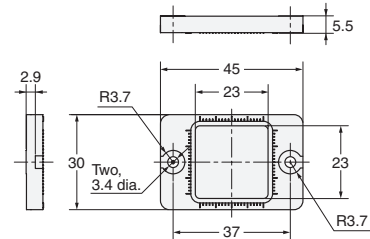

## Read and Understand This Catalog

Please read and understand this catalog before purchasing the products. Please consult your OMRON representative if you have any questions or comments.

## Warranty and Limitations of Liability

### WARRANTY

OMRON's exclusive warranty is that the products are free from defects in materials and workmanship for a period of one year (or other period if specified) from date of sale by OMRON.

OMRON MAKES NO WARRANTY OR REPRESENTATION, EXPRESS OR IMPLIED, REGARDING NON-INFRINGEMENT, MERCHANTABILITY, OR FITNESS FOR PARTICULAR PURPOSE OF THE PRODUCTS. ANY BUYER OR USER ACKNOWLEDGES THAT THE BUYER OR USER ALONE HAS DETERMINED THAT THE PRODUCTS WILL SUITABLY MEET THE REQUIREMENTS OF THEIR INTENDED USE. OMRON DISCLAIMS ALL OTHER WARRANTIES, EXPRESS OR IMPLIED.

### LIMITATIONS OF LIABILITY

OMRON SHALL NOT BE RESPONSIBLE FOR SPECIAL, INDIRECT, OR CONSEQUENTIAL DAMAGES, LOSS OF PROFITS OR COMMERCIAL LOSS IN ANY WAY CONNECTED WITH THE PRODUCTS, WHETHER SUCH CLAIM IS BASED ON CONTRACT, WARRANTY, NEGLIGENCE, OR STRICT LIABILITY.

In no event shall the responsibility of OMRON for any act exceed the individual price of the product on which liability is asserted.

IN NO EVENT SHALL OMRON BE RESPONSIBLE FOR WARRANTY, REPAIR, OR OTHER CLAIMS REGARDING THE PRODUCTS UNLESS OMRON'S ANALYSIS CONFIRMS THAT THE PRODUCTS WERE PROPERLY HANDLED, STORED, INSTALLED, AND MAINTAINED AND NOT SUBJECT TO CONTAMINATION, ABUSE, MISUSE, OR INAPPROPRIATE MODIFICATION OR REPAIR.

## Application Considerations

### SUITABILITY FOR USE

OMRON shall not be responsible for conformity with any standards, codes, or regulations that apply to the combination of products in the customer's application or use of the products.

At the customer's request, OMRON will provide applicable third party certification documents identifying ratings and limitations of use that apply to the products. This information by itself is not sufficient for a complete determination of the suitability of the products in combination with the end product, machine, system, or other application or use.

The following are some examples of applications for which particular attention must be given. This is not intended to be an exhaustive list of all possible uses of the products, nor is it intended to imply that the uses listed may be suitable for the products:

- Outdoor use, uses involving potential chemical contamination or electrical interference, or conditions or uses not described in this catalog.
- Nuclear energy control systems, combustion systems, railroad systems, aviation systems, medical equipment, amusement machines, vehicles, safety equipment, and installations subject to separate industry or government regulations.
- Systems, machines, and equipment that could present a risk to life or property.

Please know and observe all prohibitions of use applicable to the products.

NEVER USE THE PRODUCTS FOR AN APPLICATION INVOLVING SERIOUS RISK TO LIFE OR PROPERTY WITHOUT ENSURING THAT THE SYSTEM AS A WHOLE HAS BEEN DESIGNED TO ADDRESS THE RISKS, AND THAT THE OMRON PRODUCTS ARE PROPERLY RATED AND INSTALLED FOR THE INTENDED USE WITHIN THE OVERALL EQUIPMENT OR SYSTEM.

### PROGRAMMABLE PRODUCTS

OMRON shall not be responsible for the user's programming of a programmable product, or any consequence thereof.

## Disclaimers

### CHANGE IN SPECIFICATIONS

Product specifications and accessories may be changed at any time based on improvements and other reasons.

It is our practice to change model numbers when published ratings or features are changed, or when significant construction changes are made. However, some specifications of the products may be changed without any notice. When in doubt, special model numbers may be assigned to fix or establish key specifications for your application on your request. Please consult with your OMRON representative at any time to confirm actual specifications of purchased products.

### DIMENSIONS AND WEIGHTS

Dimensions and weights are nominal and are not to be used for manufacturing purposes, even when tolerances are shown.

### PERFORMANCE DATA

Performance data given in this catalog is provided as a guide for the user in determining suitability and does not constitute a warranty. It may represent the result of OMRON's test conditions, and the users must correlate it to actual application requirements. Actual performance is subject to the OMRON Warranty and Limitations of Liability.

### ERRORS AND OMISSIONS

The information in this document has been carefully checked and is believed to be accurate; however, no responsibility is assumed for clerical, typographical, or proofreading errors, or omissions.

2010.12

In the interest of product improvement, specifications are subject to change without notice.

**OMRON Corporation**  
Industrial Automation Company

<http://www.ia.omron.com/>

(c)Copyright OMRON Corporation 2010 All Right Reserved.

# Mouser Electronics

Authorized Distributor

Click to View Pricing, Inventory, Delivery & Lifecycle Information:

[Omron:](#)

[E3Z-LL61 2M](#) [E3Z-LL66](#) [E3Z-LL86](#) [E3Z-LR86](#) [E3Z-LT86](#)