

## SUMMARY



Image is for illustrative purpose only

### # Wires

Low voltage 8

Series	1B
Termination type	Female crimp
IP rating	50
AWG wire size	26.00 - 22.00
Cable Ø	0.00 - 0.00 mm
Status	active
Matching parts	<a href="#">FGG.1B.308.CYCD72Z</a>

### Download

[Request a quote](#)

[Catalog](#)

## TECHNICAL DETAILS

### Mechanics

Shell Style/Model	EC*: Fixed receptacle with two nuts (back panel mounting)
Keying	1 key (alpha=0, plug: male contacts, receptacle: female contacts)
Housing Material	Brass (chrome plated [SAE AMS 2460]) shell and collet nut, nickel plated [SAE AMS QQ N 290] brass latch sleeve and mid pieces
Weight	12.09 g

### Performance

Configuration	1B.308 : 8 Low Voltage
Insulator	Y: PEEK for crimp contacts
Rated Current	5 Amps

### Specifications

Contact Type: Crimp  
Contact Retention: 22 N  
Contact Dia.: 0.7 mm (0.028in)  
Bucket Dia.: 0.8 mm (0.031in)  
Min. Conductor: 0.14 mm<sup>2</sup> (AWG 26)  
Max. Conductor: 0.34 mm<sup>2</sup> (AWG 22)  
R (max): 6.1 mOhm  
Vtest (contact-shell): 1300 V (AC), 1840 V (DC)

LEMO products and services are provided "as is". LEMO makes no warranties or representations with regard to LEMO product & services or use of them, express, implied or statutory, including for accuracy, completeness, or security. The user is fully responsible for his products and applications using LEMO components.

Vtest (contact-contact): 1300 V (AC), 1840 V (DC)

## Others

Endurance (Shell): 5000  
Temp (min / max): -55°C / +250°C  
Humidity (max): ≤95% [at 60 deg C / 140 F]  
Vibration: 15 g [10 Hz - 2000 Hz]  
Shock Resistance: 100 g [ 6 ms]  
Climatical Category: 50/175/21  
Shielding (min): 75 dB (10 MHz)  
Shielding (min): 40 dB (1 GHz)  
Salt Spray Corrosion: >1000 hr

## DRAWINGS

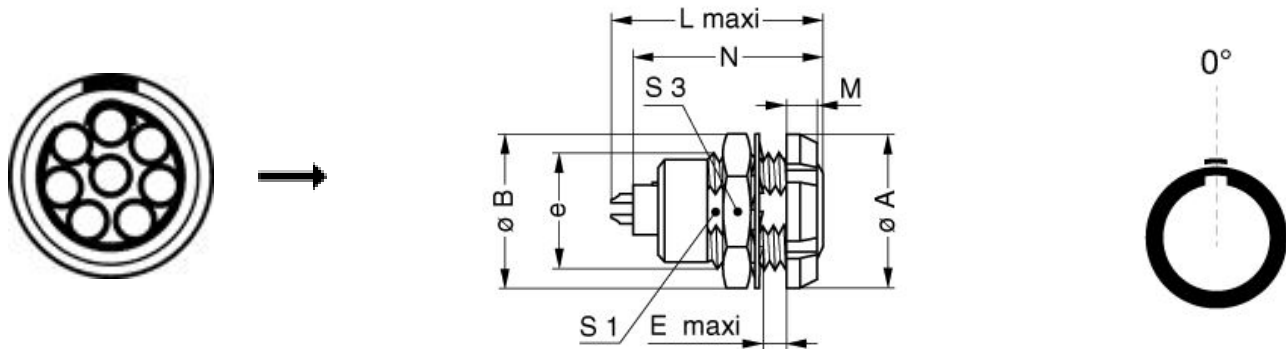

## Dimensions

	A	B	E	L	M	N	S1	S3	e
mm.	16	15.8	6	23	3.5	21.1	10.5	14	M12x1.0
in.	0,63	0,62	0,24	0,91	0,14	0,83	0,41	0,55	









## RECOMMENDED BY LEMO

### Tools

LEMO products and services are provided "as is". LEMO makes no warranties or representations with regard to LEMO product & services or use of them, express, implied or statutory, including for accuracy, completeness, or security. The user is fully responsible for his products and applications using LEMO components.

Crimp Tool: [DPC.91.701.V](#)  
 Crimp settings: AWG/Selector = 22-24-26/6-5-5  
 Positionner: [DCE.91.071.BVM](#)  
 Extractor: [DCF.91.070.2LT](#)  
 Spanner 2: [DCH.91.161.PA](#)  
 Replacement contact: EGG.1B.655.ZZM

## Cables

CMN.08.T22.059QGC	TPR	Grey	
CMN.08.T22.059QGZE	TPR (medical)	Grey	
CMN.08.T26.042QGZE	TPR (medical)	Grey	
108220	PVC	Black	
108240	PTFE	White	
108260	PTFE	White	
16080	PVC	Grey	
180240	PVC	Black	
180260	PVC	Black	
280250	PVC	Grey	
335990	PVC	Black	
335991	PVC	Black	
42265	PVC	Yellow	
80140	PVC	Grey	
8050	PVC	Black	
8280	PVC	Black	

LEMO products and services are provided "as is". LEMO makes no warranties or representations with regard to LEMO product & services or use of them, express, implied or statutory, including for accuracy, completeness, or security. The user is fully responsible for his products and applications using LEMO components.

# Mouser Electronics

Authorized Distributor

Click to View Pricing, Inventory, Delivery & Lifecycle Information:

[LEMO:](#)

[ECG.1B.308.CYM](#)