

ZXTD6717E6

COMPLEMENTARY 15V NPN & 12V PNP LOW SATURATION TRANSISTORS IN SOT26

Features and Benefits

- Pd = 1.1W in SOT26 Package
- **Totally Lead-Free & Fully RoHS Compliant (Notes 1 & 2)**
- **Halogen and Antimony Free. "Green" Device (Note 3)**
- **Qualified to AEC-Q101 Standards for High Reliability**
- **PPAP Capable (Note 4)**

NPN Transistor

- $BV_{CEO} > 15V$
- $I_C = 1.5A$ Continuous Collector Current
- Low Saturation Voltage (100mV max @ 1A)
- $R_{SAT} = 135m\Omega @ 1.5A$ for a Low Equivalent On-Resistance

PNP Transistor

- $BV_{CEO} > -12V$
- $I_C = -1.25A$ Continuous Collector Current
- Low Saturation Voltage (-140mV max @ -1A)
- $R_{SAT} = 150m\Omega @ 1.2A$ for a Low Equivalent On-Resistance

Mechanical Data

- Case: SOT26
- Case Material: Molded Plastic, "Green" Molding Compound; UL Flammability Classification Rating 94V-0
- Moisture Sensitivity: Level 1 per J-STD-020
- Terminals: Finish – Matte Tin Plated Leads; Solderable per MIL-STD-202, Method 208 (3)
- Weight: 0.015 grams (Approximate)

Applications

- Efficient Driving Functions including Motors, Lamps, Relays and Solenoids
- High Output Current Switches

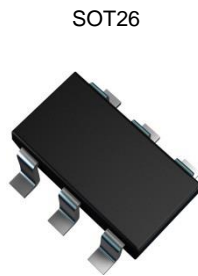

Top View

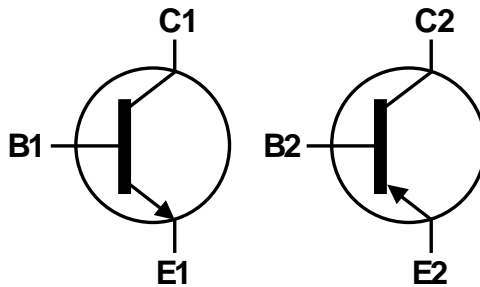

NPN Transistor

PNP Transistor

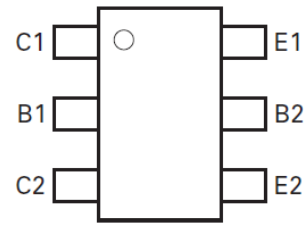

Top View
Pin-Out

Device Symbol

Ordering Information (Notes 4 & 5)

Product	Compliance	Marking	Reel size (inches)	Tape width (mm)	Quantity per reel
ZXTD6717E6TA	AEC-Q101	6717	7	8	3,000
ZXTD6717E6QTA	Automotive	6717	7	8	3,000

- Notes:
1. No purposely added lead. Fully EU Directive 2002/95/EC (RoHS) & 2011/65/EU (RoHS 2) compliant.
 2. See http://www.diodes.com/quality/lead_free.html for more information about Diodes Incorporated's definitions of Halogen- and Antimony-free, "Green" and Lead-free.
 3. Halogen- and Antimony-free "Green" products are defined as those which contain <900ppm bromine, <900ppm chlorine (<1500ppm total Br + Cl) and <1000ppm antimony compounds.
 4. Automotive products are AEC-Q101 qualified and are PPAP capable. Automotive, AEC-Q101 and standard products are electrically and thermally the same, except where specified. For more information, please refer to http://www.diodes.com/quality/product_compliance_definitions/.
 5. For packaging details, go to our website at <http://www.diodes.com/products/packages.html>.

Marking Information

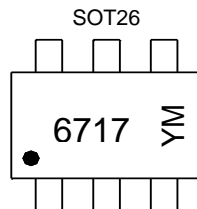

6717 = Product Type Marking Code
 YM = Date Code Marking
 Y or \bar{Y} = Year (ex: C = 2015)
 M or \bar{M} = Month (ex: 9 = September)

Date Code Key

Year	2015	2016	2017	2018	2019	2020	2021	2022	2023	2024	2025
Code	C	D	E	F	G	H	I	J	K	L	M

Month	Jan	Feb	Mar	Apr	May	Jun	Jul	Aug	Sep	Oct	Nov	Dec
Code	1	2	3	4	5	6	7	8	9	O	N	D

ZXTD6717E6

NPN - Absolute Maximum Ratings (@T_A = +25°C, unless otherwise specified.)

Characteristic	Symbol	Value	Unit
Collector-Base Voltage	V _{CBO}	15	V
Collector-Emitter Voltage	V _{CEO}	15	V
Emitter-Base Voltage	V _{EBO}	7	V
Peak Pulse Current	I _{CM}	5	A
Continuous Collector Current	I _C	1.5	A
Base Current	I _B	200	mA

PNP - Absolute Maximum Ratings (@T_A = +25°C, unless otherwise specified.)

Characteristic	Symbol	Value	Unit
Collector-Base Voltage	V _{CBO}	-12	V
Collector-Emitter Voltage	V _{CEO}	-12	V
Emitter-Base Voltage	V _{EBO}	-7	V
Peak Pulse Current	I _{CM}	-3	A
Continuous Collector Current	I _C	-1.25	A
Base Current	I _B	-200	mA

Thermal Characteristics (@T_A = +25°C, unless otherwise specified.)

Characteristic	Symbol	Value	Unit
Power Dissipation Linear Derating Factor	P _D	1.1	W
		8.8	
		1.7	
Thermal Resistance, Junction to Ambient	R _{θJA}	13.6	mW/°C
		125	
Thermal Resistance, Junction to Lead	R _{θJL}	45	°C/W
		95	
Operating and Storage Temperature Range	T _J , T _{STG}	-55 to +150	°C

ESD Ratings (Note 9)

Characteristic	Symbol	Value	Unit	JEDEC Class
Electrostatic Discharge - Human Body Model	ESD HBM	4,000	V	3A
Electrostatic Discharge - Machine Model	ESD MM	400	V	C

- Notes:
- 6. For a device mounted with the collector lead on 25mm x 25mm 1oz copper that is on a single-sided 1.6mm FR4 PCB; the device is measured under still air conditions whilst operating in a steady-state. Two active dice running at equal power with heatsink split 50% to each collector.
 - 7. Same as Note 6, except the device is measured at t < 5 seconds.
 - 8. Thermal resistance from junction to solder-point (at the end of the collector lead).
 - 9. Refer to JEDEC specification JESD22-A114 and JESD22-A115.

NPN - Electrical Characteristics (@T_A = +25°C, unless otherwise specified.)

Characteristic	Symbol	Min	Typ	Max	Unit	Test Condition
OFF CHARACTERISTICS						
Collector-Base Breakdown Voltage	BV _{CBO}	15	—	—	V	I _C = 100μA, I _E = 0
Collector-Emitter Breakdown Voltage (Note 10)	BV _{CEO}	15	—	—	V	I _C = 10mA, I _B = 0
Emitter-Base Breakdown Voltage	BV _{EBO}	7	—	—	V	I _E = 100μA, I _C = 0
Collector Cut-Off Current	I _{CBO}	—	<-1	10	nA	V _{CB} = 10V
Emitter Cut-Off Current	I _{EBO}	—	<-1	10	nA	V _{EB} = 5.6
Emitter Cut-Off Current	I _{CES}	—	<-1	10	nA	V _{CE} = 10V
ON CHARACTERISTICS (Note 10)						
DC Current Gain	h _{FE}	200	420	—	—	I _C = 10mA, V _{CE} = 2V
		300	450	—		I _C = 100mA, V _{CE} = 2V
		250	390	—		I _C = 500mA, V _{CE} = 2V
		200	300	—		I _C = 1A, V _{CE} = 2V
		75	150	—		I _C = 3A, V _{CE} = 2V
30	75	—	I _C = 5A, V _{CE} = 2V			
Collector-Emitter Saturation Voltage	V _{CE(sat)}	—	16.5	20	mV	I _C = 100mA, I _B = 10mA
		—	40	55	mV	I _C = 250mA, I _B = 10mA
		—	75	100	mV	I _C = 500mA, I _B = 10mA
		—	150	200	mV	I _C = 1A, I _B = 10mA
		—	205	245	mV	I _C = 1.5A, I _B = 20mA
Base-Emitter Saturation Voltage	V _{BE(sat)}	—	0.93	1.10	V	I _C = 1.5A, I _B = 20mA
Base-Emitter Turn-On Voltage	V _{BE(on)}	—	0.865	1.10	V	I _C = 1.5A, V _{CE} = 2V
SMALL SIGNAL CHARACTERISTICS						
Output Capacitance	C _{obo}	—	15	—	pF	V _{CB} = 10V, f = 1.0MHz
Current Gain Bandwidth Product	f _T	—	180	—	MHz	I _C = 50mA, V _{CE} = 10V f = 100MHz
SWITCHING CHARACTERISTICS						
Turn-On Time	t _{on}	—	50	—	ns	I _C = 1A, V _{CC} = 10V
Turn-Off Time	t _{off}	—	250	—	ns	I _{B1} = -I _{B2} = 100mA

Note: 10. Measured under pulsed conditions. Pulse width ≤ 300μs. Duty cycle ≤ 2%.

NPN - Typical Electrical Characteristics (@ $T_A = +25^\circ\text{C}$, unless otherwise specified.)

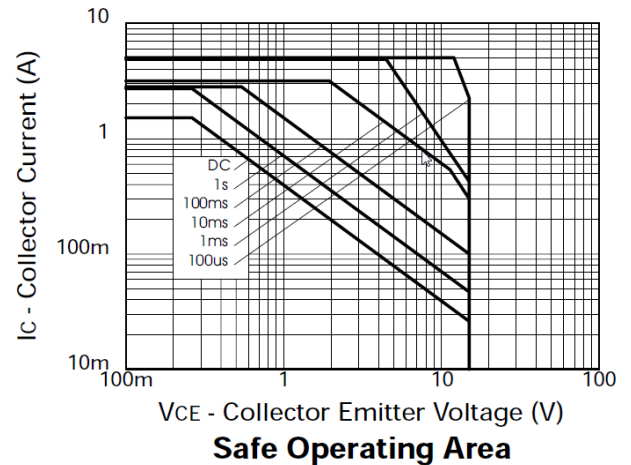
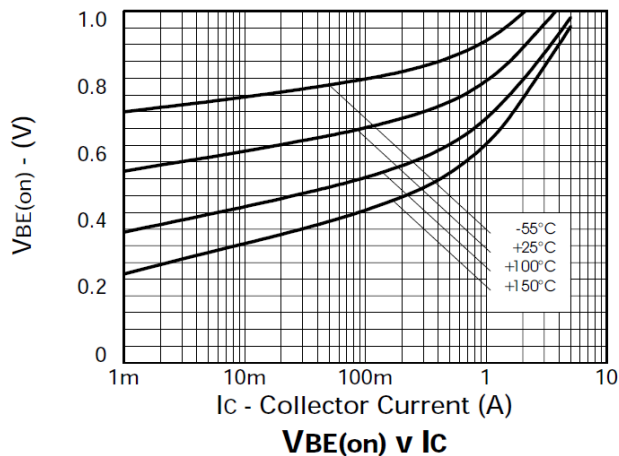
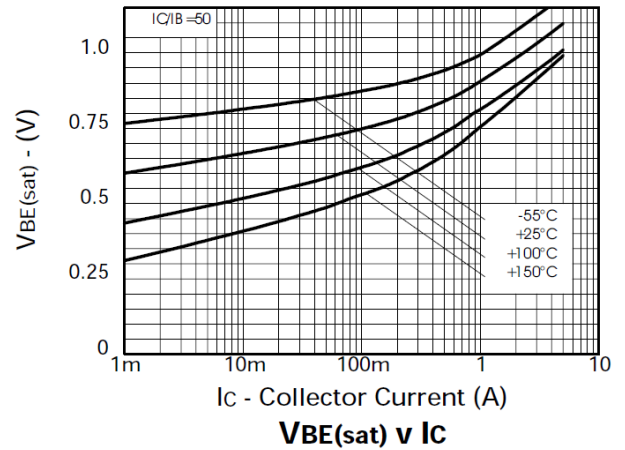
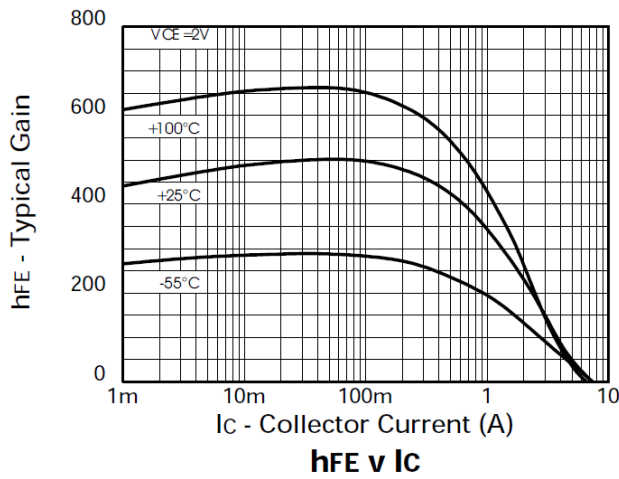
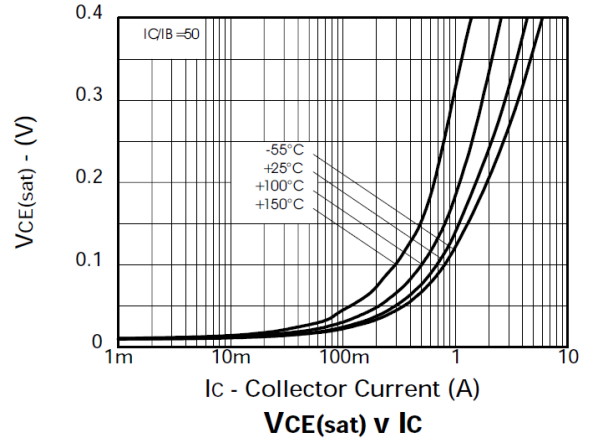
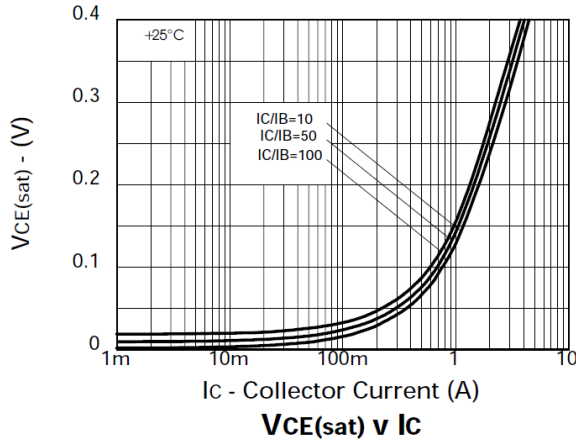

PNP - Electrical Characteristics (@T_A = +25°C, unless otherwise specified.)

Characteristic	Symbol	Min	Typ	Max	Unit	Test Condition
OFF CHARACTERISTICS						
Collector-Base Breakdown Voltage	BV _{CBO}	-12	—	—	V	I _C = -100μA, I _E = 0
Collector-Emitter Breakdown Voltage (Note 11)	BV _{CEO}	-12	—	—	V	I _C = -10mA, I _B = 0
Emitter-Base Breakdown Voltage	BV _{EBO}	-7	—	—	V	I _E = -100μA, I _C = 0
Collector Cut-Off Current	I _{CBO}	—	<-1	-10	nA	V _{CB} = -10V
Emitter Cut-Off Current	I _{EBO}	—	<-1	-10	nA	V _{EB} = -5.6V
Emitter Cut-Off Current	I _{CES}	—	<-1	-10	nA	V _{CE} = -10V
ON CHARACTERISTICS (Note 11)						
DC Current Gain	h _{FE}	300	490	—	—	I _C = -10mA, V _{CE} = -2V
		300	450	—		I _C = -100mA, V _{CE} = -2V
		200	340	—		I _C = -500mA, V _{CE} = -2V
		125	250	—		I _C = -1.25A, V _{CE} = -2V
		75	140	—		I _C = -2A, V _{CE} = -2V
30	80	—	I _C = -3A, V _{CE} = -2V			
Collector-Emitter Saturation Voltage	V _{CE(sat)}	—	-25	-40	mV	I _C = -100mA, I _B = -10mA
		—	-55	-100	mV	I _C = -250mA, I _B = -10mA
		—	-110	-175	mV	I _C = -500mA, I _B = -10mA
		—	-160	-215	mV	I _C = -1A, I _B = -50mA
		—	-185	-240	mV	I _C = -1.25A, I _B = -100mA
Base-Emitter Saturation Voltage	V _{BE(sat)}	—	-0.99	-1.10	V	I _C = -1.25A, I _B = -100mA
Base-Emitter Turn-On Voltage	V _{BE(on)}	—	-0.85	-1.0	V	I _C = -1.25A, V _{CE} = -2V
SMALL SIGNAL CHARACTERISTICS						
Output Capacitance	C _{obo}	—	15	—	pF	V _{CB} = -10V, f = 1.0MHz
Current Gain Bandwidth Product	f _T	—	220	—	MHz	I _C = -50mA, V _{CE} = -10V f = 100MHz
SWITCHING CHARACTERISTICS						
Turn-On Time	t _{on}	—	50	—	ns	I _C = -1A, V _{CC} = -10V
Turn-Off Time	t _{off}	—	135	—	ns	I _{B1} = -I _{B2} = -100mA

Note: 11. Measured under pulsed conditions. Pulse width ≤ 300μs. Duty cycle ≤ 2%.

PNP - Typical Electrical Characteristics (@ $T_A = +25^\circ\text{C}$, unless otherwise specified.)

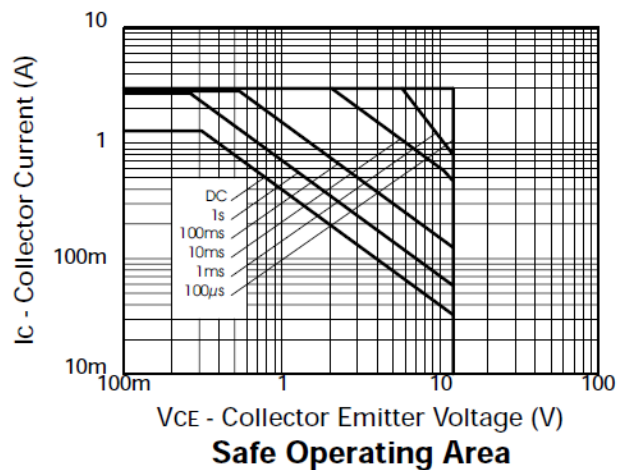
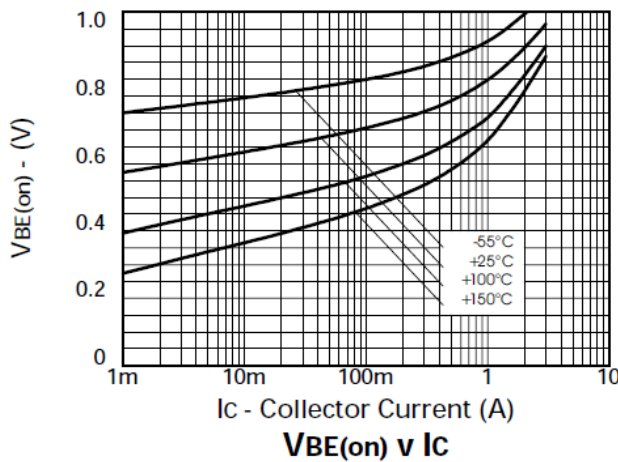
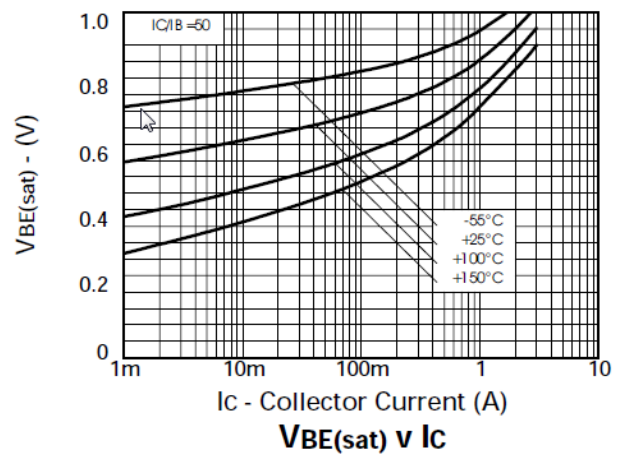
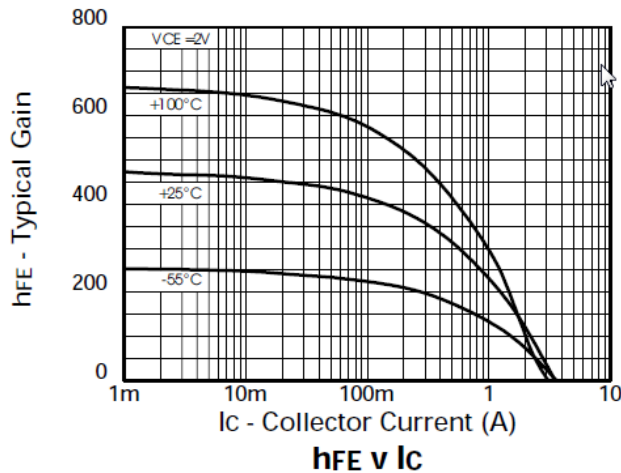
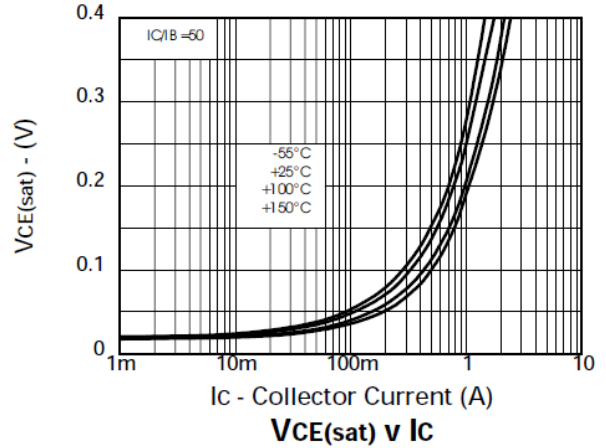
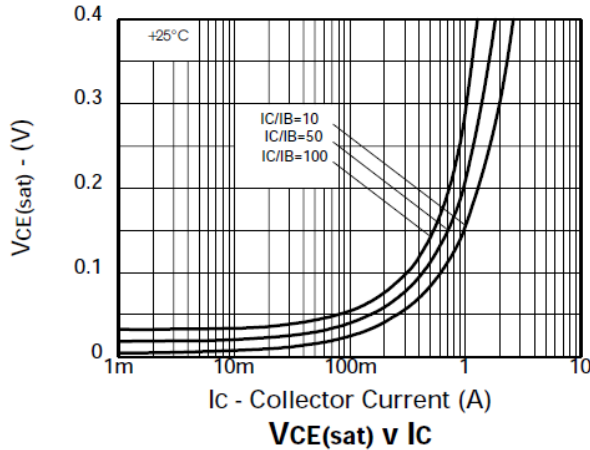

Package Outline Dimensions

Please see AP02002 at <http://www.diodes.com/datasheets/ap02002.pdf> for the latest version.

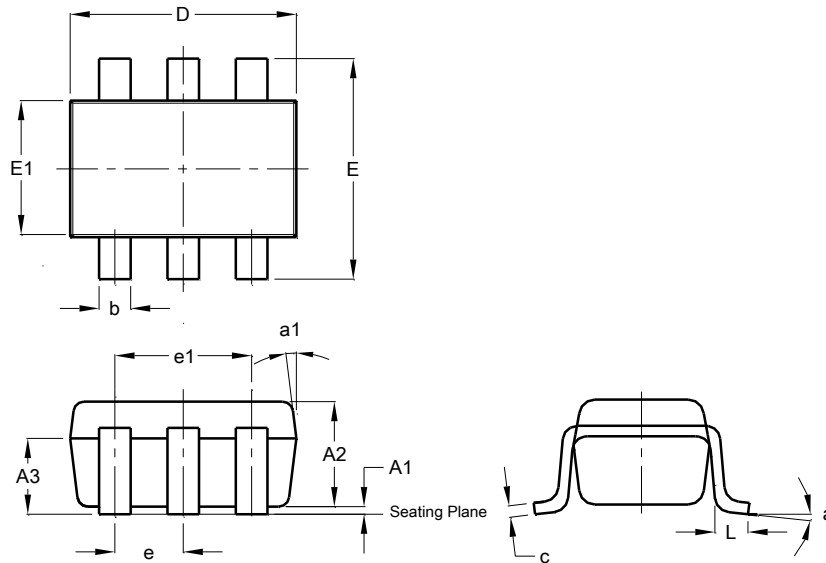

SOT26			
Dim	Min	Max	Typ
A1	0.013	0.10	0.05
A2	1.00	1.30	1.10
A3	0.70	0.80	0.75
b	0.35	0.50	0.38
c	0.10	0.20	0.15
D	2.90	3.10	3.00
e	-	-	0.95
e1	-	-	1.90
E	2.70	3.00	2.80
E1	1.50	1.70	1.60
L	0.35	0.55	0.40
a	-	-	8°
a1	-	-	7°
All Dimensions in mm			

Suggested Pad Layout

Please see AP02001 at <http://www.diodes.com/datasheets/ap02001.pdf> for the latest version.

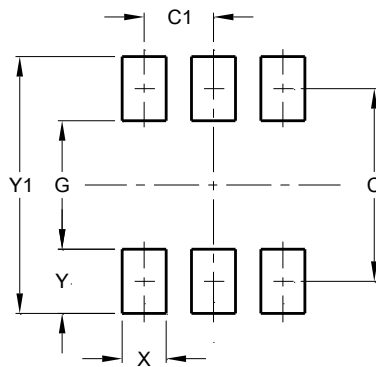

Dimensions	Value (in mm)
C	2.40
C1	0.95
G	1.60
X	0.55
Y	0.80
Y1	3.20

IMPORTANT NOTICE

DIODES INCORPORATED MAKES NO WARRANTY OF ANY KIND, EXPRESS OR IMPLIED, WITH REGARDS TO THIS DOCUMENT, INCLUDING, BUT NOT LIMITED TO, THE IMPLIED WARRANTIES OF MERCHANTABILITY AND FITNESS FOR A PARTICULAR PURPOSE (AND THEIR EQUIVALENTS UNDER THE LAWS OF ANY JURISDICTION).

Diodes Incorporated and its subsidiaries reserve the right to make modifications, enhancements, improvements, corrections or other changes without further notice to this document and any product described herein. Diodes Incorporated does not assume any liability arising out of the application or use of this document or any product described herein; neither does Diodes Incorporated convey any license under its patent or trademark rights, nor the rights of others. Any Customer or user of this document or products described herein in such applications shall assume all risks of such use and will agree to hold Diodes Incorporated and all the companies whose products are represented on Diodes Incorporated website, harmless against all damages.

Diodes Incorporated does not warrant or accept any liability whatsoever in respect of any products purchased through unauthorized sales channel. Should Customers purchase or use Diodes Incorporated products for any unintended or unauthorized application, Customers shall indemnify and hold Diodes Incorporated and its representatives harmless against all claims, damages, expenses, and attorney fees arising out of, directly or indirectly, any claim of personal injury or death associated with such unintended or unauthorized application.

Products described herein may be covered by one or more United States, international or foreign patents pending. Product names and markings noted herein may also be covered by one or more United States, international or foreign trademarks.

This document is written in English but may be translated into multiple languages for reference. Only the English version of this document is the final and determinative format released by Diodes Incorporated.

LIFE SUPPORT

Diodes Incorporated products are specifically not authorized for use as critical components in life support devices or systems without the express written approval of the Chief Executive Officer of Diodes Incorporated. As used herein:

A. Life support devices or systems are devices or systems which:

1. are intended to implant into the body, or
2. support or sustain life and whose failure to perform when properly used in accordance with instructions for use provided in the labeling can be reasonably expected to result in significant injury to the user.

B. A critical component is any component in a life support device or system whose failure to perform can be reasonably expected to cause the failure of the life support device or to affect its safety or effectiveness.

Customers represent that they have all necessary expertise in the safety and regulatory ramifications of their life support devices or systems, and acknowledge and agree that they are solely responsible for all legal, regulatory and safety-related requirements concerning their products and any use of Diodes Incorporated products in such safety-critical, life support devices or systems, notwithstanding any devices- or systems-related information or support that may be provided by Diodes Incorporated. Further, Customers must fully indemnify Diodes Incorporated and its representatives against any damages arising out of the use of Diodes Incorporated products in such safety-critical, life support devices or systems.

Copyright © 2015, Diodes Incorporated

www.diodes.com

Mouser Electronics

Authorized Distributor

Click to View Pricing, Inventory, Delivery & Lifecycle Information:

[Diodes Incorporated:](#)

[ZXTD6717E6TA](#) [ZXTD6717E6QTA](#)