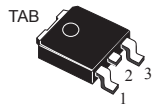
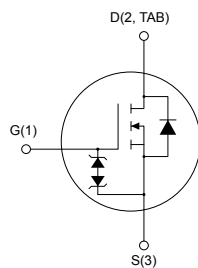

N-channel 600 V, 1.38 Ω typ., 3.5 A MDmesh™ DM2 Power MOSFET in a DPAK package

DPAK

AM01475V1

Features

Order code	V_{DS}	$R_{DS(on)}$ max.	I_D	P_{TOT}
STD5N60DM2	600 V	1.55 Ω	3.5 A	45 W

- Fast-recovery body diode
- Extremely low gate charge and input capacitance
- Low on-resistance
- 100% avalanche tested
- Extremely high dv/dt ruggedness
- Zener-protected

Applications

- Switching applications

Description

This high-voltage N-channel Power MOSFET is part of the MDmesh™ DM2 fast recovery diode series. It offers very low recovery charge (Q_{rr}) and time (t_{rr}) combined with low $R_{DS(on)}$, rendering it suitable for the most demanding high-efficiency converters and ideal for bridge topologies and ZVS phase-shift converters.

Product status link

[STD5N60DM2](#)

Product summary

Order code	STD5N60DM2
Marking	5N60DM2
Package	DPAK
Packing	Tape and reel

1 Electrical ratings

Table 1. Absolute maximum ratings

Symbol	Parameter	Value	Unit
V_{GS}	Gate-source voltage	± 30	V
I_D	Drain current (continuous) at $T_{case} = 25\text{ }^\circ\text{C}$	3.5	A
	Drain current (continuous) at $T_{case} = 100\text{ }^\circ\text{C}$	2	
$I_{DM}^{(1)}$	Drain current (pulsed)	14	A
P_{TOT}	Total dissipation at $T_{case} = 25\text{ }^\circ\text{C}$	45	W
$dv/dt^{(2)}$	Peak diode recovery voltage slope	40	V/ns
$dv/dt^{(3)}$	MOSFET dv/dt ruggedness	40	
T_{stg}	Storage temperature range	-55 to 150	$^\circ\text{C}$
T_j	Operating junction temperature range		

1. Pulse width is limited by safe operating area.
2. $I_{SD} \leq 3.5\text{ A}$, $di/dt=400\text{ A}/\mu\text{s}$; $V_{DS\text{ peak}} < V_{(BR)DSS}$, $V_{DD} = 480\text{ V}$.
3. $V_{DS} \leq 480\text{ V}$.

Table 2. Thermal data

Symbol	Parameter	Value	Unit
$R_{thj-case}$	Thermal resistance junction-case	2.78	$^\circ\text{C}/\text{W}$
$R_{thj-pcb}^{(1)}$	Thermal resistance junction-pcb	50	

1. When mounted on a 1-inch² FR-4, 2 Oz copper board.

Table 3. Avalanche characteristics

Symbol	Parameter	Value	Unit
$I_{AR}^{(1)}$	Avalanche current, repetitive or not repetitive	1	A
$E_{AS}^{(2)}$	Single pulse avalanche energy	132	mJ

1. Pulse width limited by T_{jmax} .
2. Starting $T_j = 25\text{ }^\circ\text{C}$, $I_D = I_{AR}$, $V_{DD} = 50\text{ V}$.

2 Electrical characteristics

($T_{case} = 25\text{ °C}$ unless otherwise specified).

Table 4. Static

Symbol	Parameter	Test conditions	Min.	Typ.	Max.	Unit
$V_{(BR)DSS}$	Drain-source breakdown voltage	$V_{GS} = 0\text{ V}, I_D = 1\text{ mA}$	600			V
I_{DSS}	Zero gate voltage drain current	$V_{GS} = 0\text{ V}, V_{DS} = 600\text{ V}$			1	μA
		$V_{GS} = 0\text{ V}, V_{DS} = 600\text{ V}, T_{case} = 125\text{ °C}^{(1)}$			100	
I_{GSS}	Gate-body leakage current	$V_{DS} = 0\text{ V}, V_{GS} = \pm 25\text{ V}$			± 5	μA
$V_{GS(th)}$	Gate threshold voltage	$V_{DS} = V_{GS}, I_D = 250\text{ }\mu\text{A}$	3	4	5	V
$R_{DS(on)}$	Static drain-source on-resistance	$V_{GS} = 10\text{ V}, I_D = 1.75\text{ A}$		1.38	1.55	Ω

1. Defined by design, not subject to production test.

Table 5. Dynamic

Symbol	Parameter	Test conditions	Min.	Typ.	Max.	Unit
C_{iss}	Input capacitance	$V_{DS} = 100\text{ V}, f = 1\text{ MHz}, V_{GS} = 0\text{ V}$	-	214	-	pF
C_{oss}	Output capacitance		-	12	-	
C_{riss}	Reverse transfer capacitance		-	3.5	-	
$C_{oss\text{ eq.}}^{(1)}$	Equivalent output capacitance	$V_{DS} = 0\text{ to }480\text{ V}, V_{GS} = 0\text{ V}$	-	21	-	pF
R_G	Intrinsic gate resistance	$f = 1\text{ MHz}, I_D = 0\text{ A}$	-	6.5	-	Ω
Q_g	Total gate charge	$V_{DD} = 480\text{ V}, I_D = 3.5\text{ A}, V_{GS} = 0\text{ to }10\text{ V}$ (see Figure 14. Test circuit for gate charge behavior)	-	5.3	-	nC
Q_{gs}	Gate-source charge		-	1.4	-	
Q_{gd}	Gate-drain charge		-	2.7	-	

1. $C_{oss\text{ eq.}}$ is defined as a constant equivalent capacitance giving the same charging time as C_{oss} when V_{DS} increases from 0 to 80% V_{DSS} .

Table 6. Switching times

Symbol	Parameter	Test conditions	Min.	Typ.	Max.	Unit
$t_{d(on)}$	Turn-on delay time	$V_{DD} = 300\text{ V}, I_D = 1.75\text{ A}, R_G = 4.7\text{ }\Omega, V_{GS} = 10\text{ V}$ (see Figure 13. Test circuit for resistive load switching times and Figure 18. Switching time waveform)	-	7.2	-	ns
t_r	Rise time		-	4.1	-	
$t_{d(off)}$	Turn-off delay time		-	17	-	
t_f	Fall time		-	19.8	-	

Table 7. Source-drain diode

Symbol	Parameter	Test conditions	Min.	Typ.	Max.	Unit
I_{SD}	Source-drain current		-		3.5	A
$I_{SDM}^{(1)}$	Source-drain current (pulsed)		-		14	A
$V_{SD}^{(2)}$	Forward on voltage	$V_{GS} = 0\text{ V}$, $I_{SD} = 3.5\text{ A}$	-		1.6	V
t_{rr}	Reverse recovery time	$I_{SD} = 3.5\text{ A}$, $di/dt = 100\text{ A}/\mu\text{s}$, $V_{DD} = 60\text{ V}$ (see Figure 15. Test circuit for inductive load switching and diode recovery times)	-	58	70	ns
Q_{rr}	Reverse recovery charge		-	109		nC
I_{RRM}	Reverse recovery current		-	4		A
t_{rr}	Reverse recovery time	$I_{SD} = 3.5\text{ A}$, $di/dt = 100\text{ A}/\mu\text{s}$, $V_{DD} = 60\text{ V}$, $T_j = 150\text{ °C}$ (see Figure 15. Test circuit for inductive load switching and diode recovery times)	-	109		ns
Q_{rr}	Reverse recovery charge		-	309		nC
I_{RRM}	Reverse recovery current		-	5		A

1. Pulse width is limited by safe operating area.
2. Pulse test: pulse duration = 300 μs , duty cycle 1.5%.

2.1 Electrical characteristics (curves)

Figure 1. Safe operating area

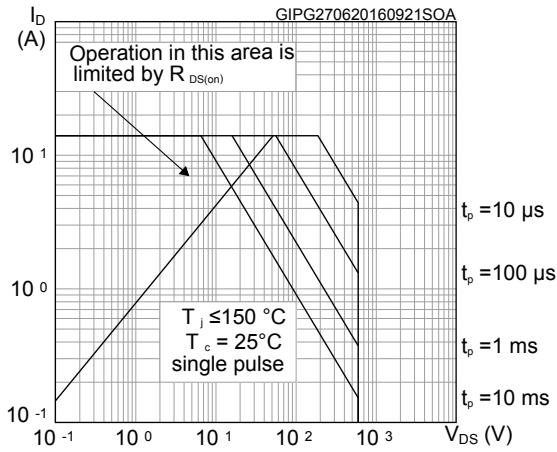

Figure 2. Thermal impedance

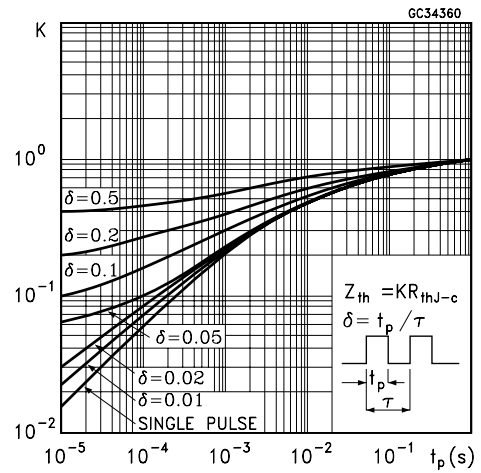

Figure 3. Output characteristics

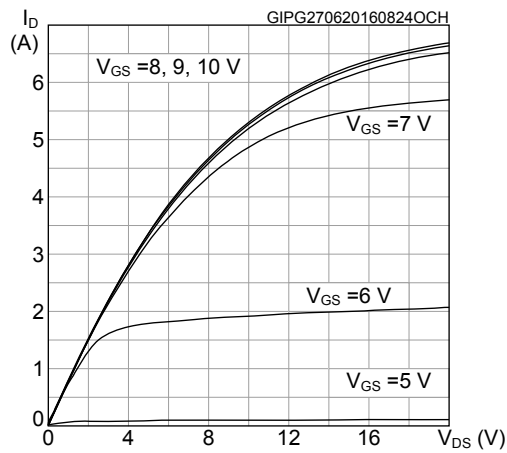

Figure 4. Transfer characteristics

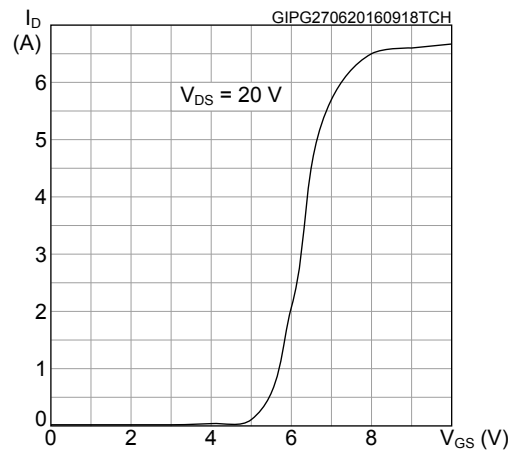

Figure 5. Gate charge vs gate-source voltage

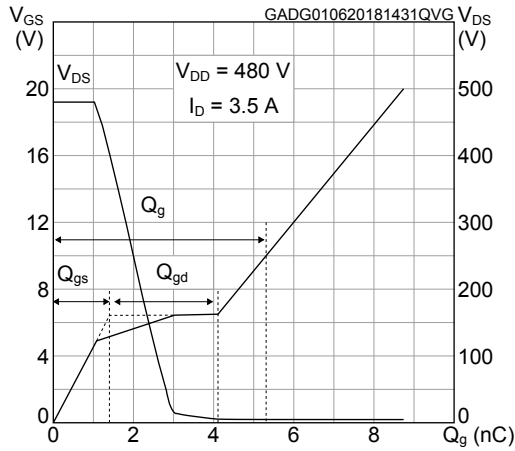

Figure 6. Static drain-source on-resistance

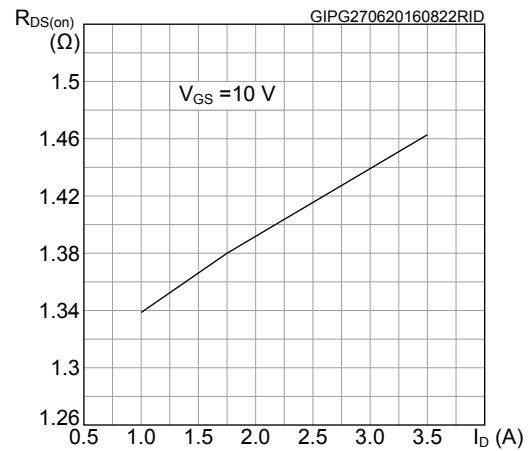

Figure 7. Capacitance variations

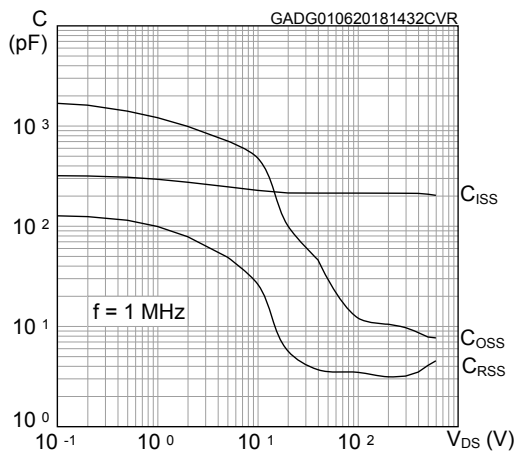

Figure 8. Output capacitance stored energy

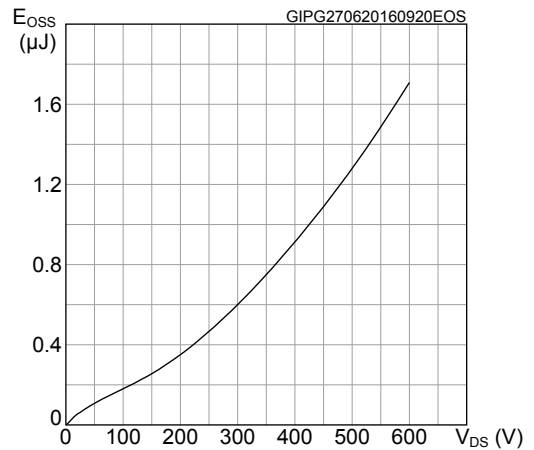

Figure 9. Normalized gate threshold voltage vs temperature

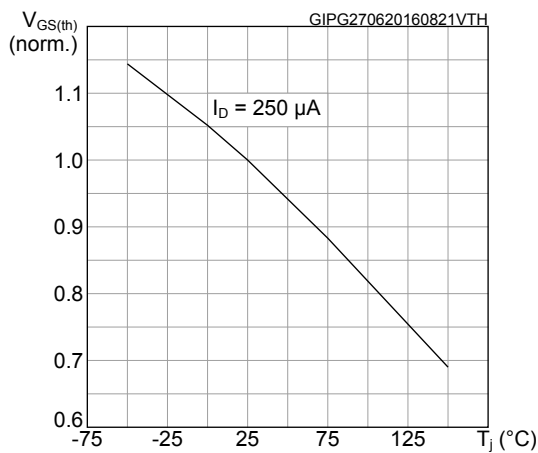

Figure 10. Normalized on-resistance vs temperature

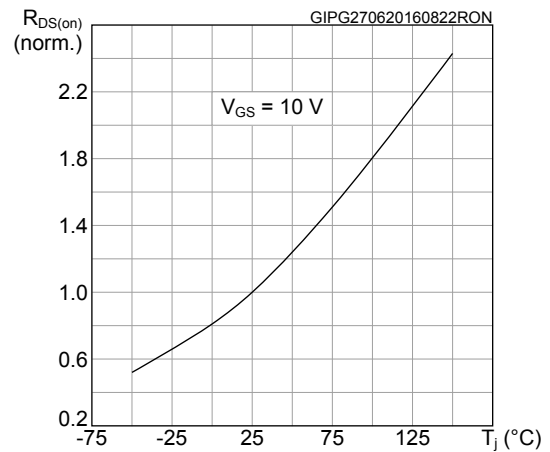

Figure 11. Source-drain diode forward characteristics

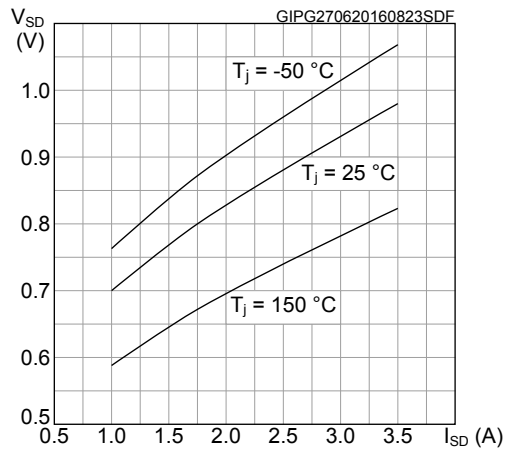
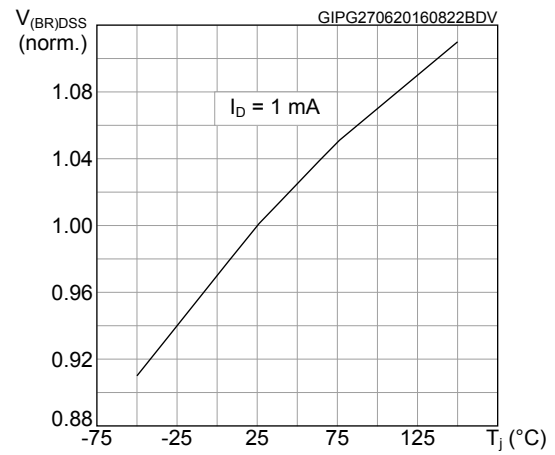
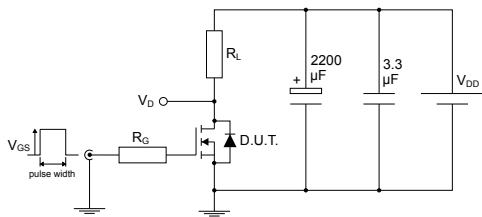

Figure 12. Normalized $V_{(BR)DSS}$ vs temperature



3 Test circuits

Figure 13. Test circuit for resistive load switching times

AM01468v1

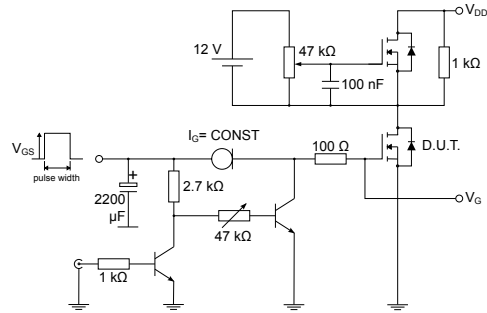
Figure 14. Test circuit for gate charge behavior

AM01469v1

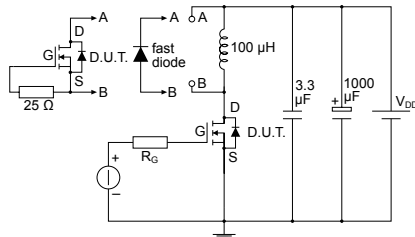
Figure 15. Test circuit for inductive load switching and diode recovery times

AM01470v1

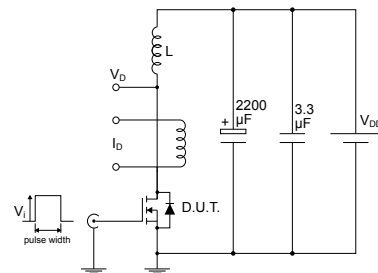
Figure 16. Unclamped inductive load test circuit

AM01471v1

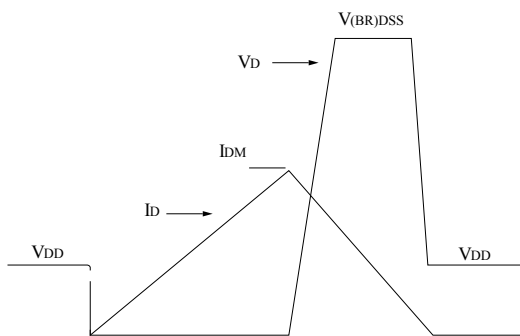
Figure 17. Unclamped inductive waveform

AM01472v1

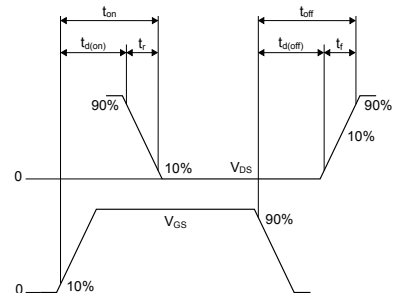
Figure 18. Switching time waveform

AM01473v1

4 Package information

In order to meet environmental requirements, ST offers these devices in different grades of ECOPACK® packages, depending on their level of environmental compliance. ECOPACK® specifications, grade definitions and product status are available at: www.st.com. ECOPACK® is an ST trademark.

4.1 DPAK (TO-252) type A package information

Figure 19. DPAK (TO-252) type A package outline

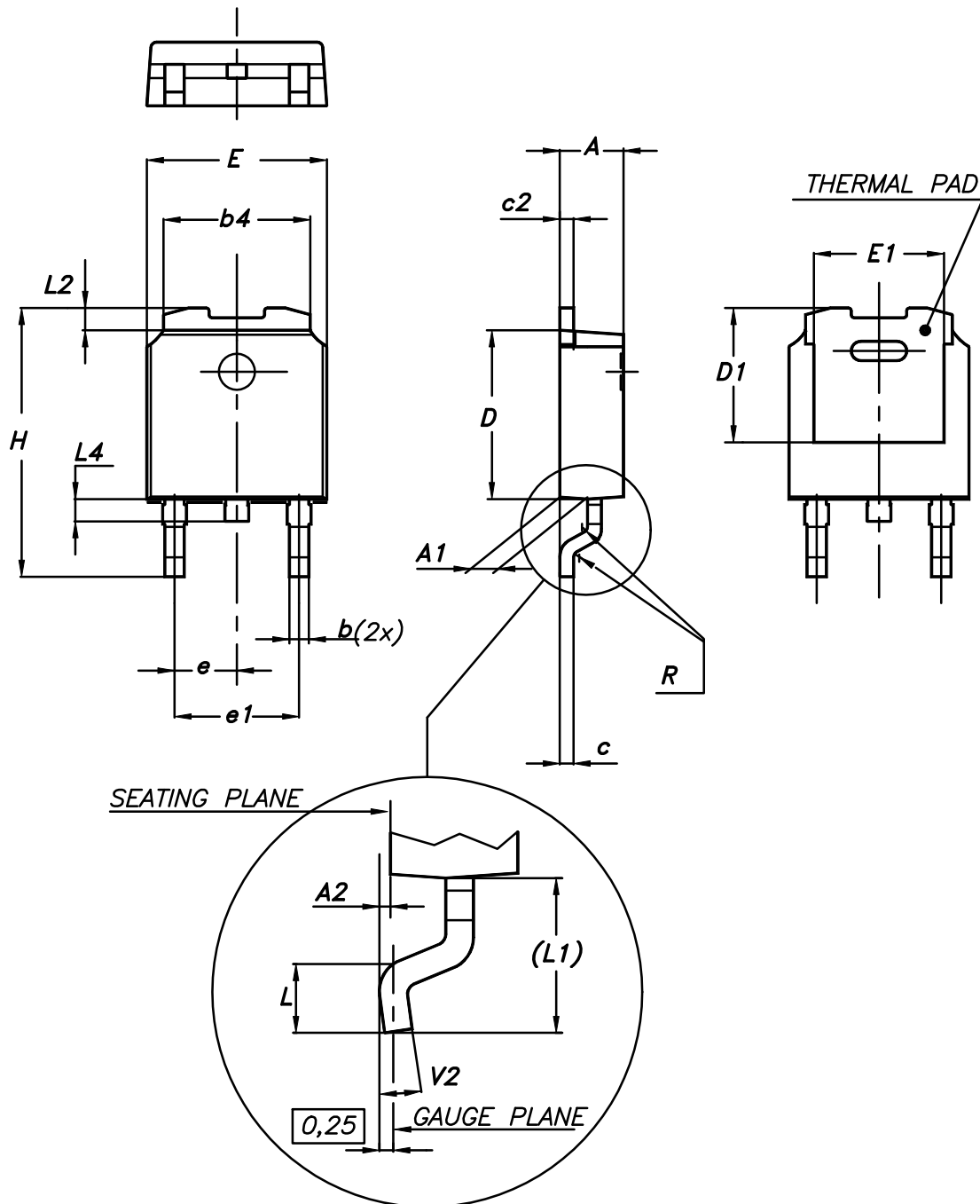

0068772_A_25

Table 8. DPAK (TO-252) type A mechanical data

Dim.	mm		
	Min.	Typ.	Max.
A	2.20		2.40
A1	0.90		1.10
A2	0.03		0.23
b	0.64		0.90
b4	5.20		5.40
c	0.45		0.60
c2	0.48		0.60
D	6.00		6.20
D1	4.95	5.10	5.25
E	6.40		6.60
E1	4.60	4.70	4.80
e	2.159	2.286	2.413
e1	4.445	4.572	4.699
H	9.35		10.10
L	1.00		1.50
(L1)	2.60	2.80	3.00
L2	0.65	0.80	0.95
L4	0.60		1.00
R		0.20	
V2	0°		8°

4.2 DPAK (TO-252) type E package information

Figure 20. DPAK (TO-252) type E package outline

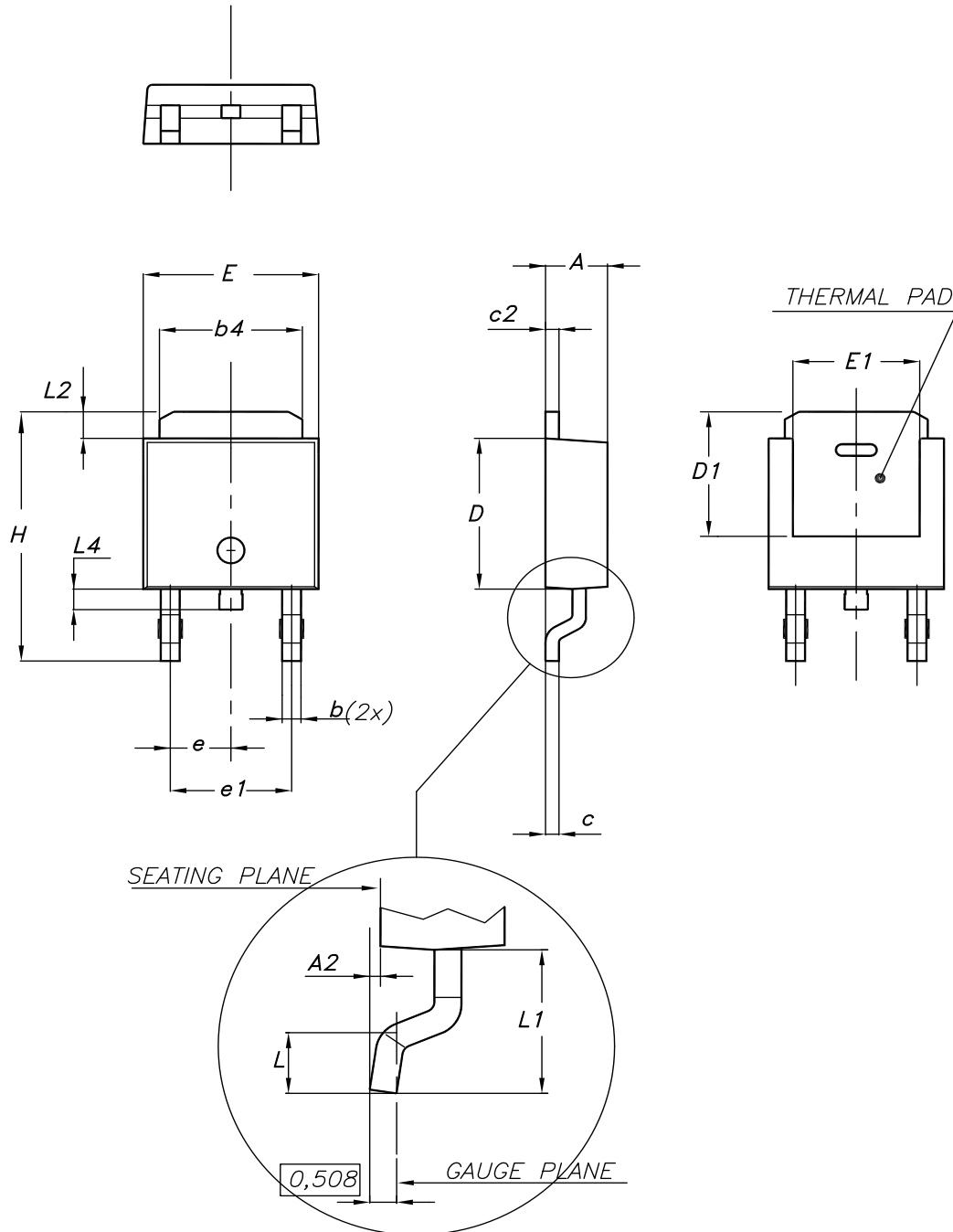

0068772_type-E_rev.25

Table 9. DPAK (TO-252) type E mechanical data

Dim.	mm		
	Min.	Typ.	Max.
A	2.18		2.39
A2			0.13
b	0.65		0.884
b4	4.95		5.46
c	0.46		0.61
c2	0.46		0.60
D	5.97		6.22
D1	5.21		
E	6.35		6.73
E1	4.32		
e		2.286	
e1		4.572	
H	9.94		10.34
L	1.50		1.78
L1		2.74	
L2	0.89		1.27
L4			1.02

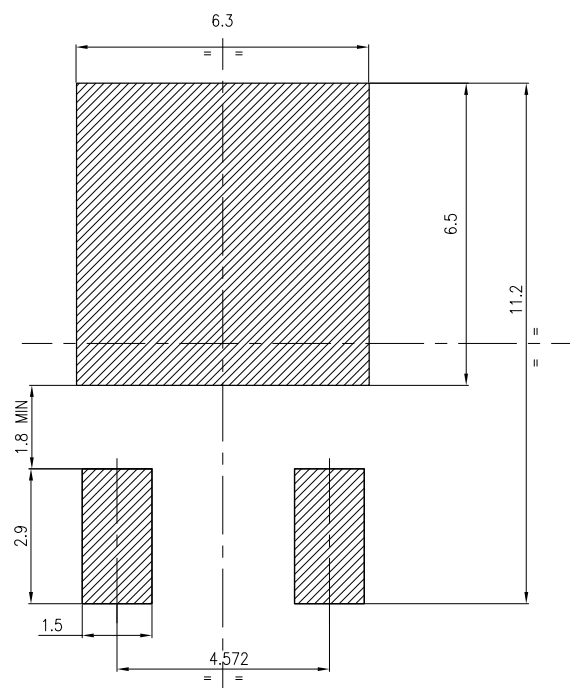
Figure 21. DPAK (TO-252) type E recommended footprint (dimensions are in mm)

FP_0068772_25

4.3 DPAK (TO-252) packing information

Figure 22. DPAK (TO-252) tape outline

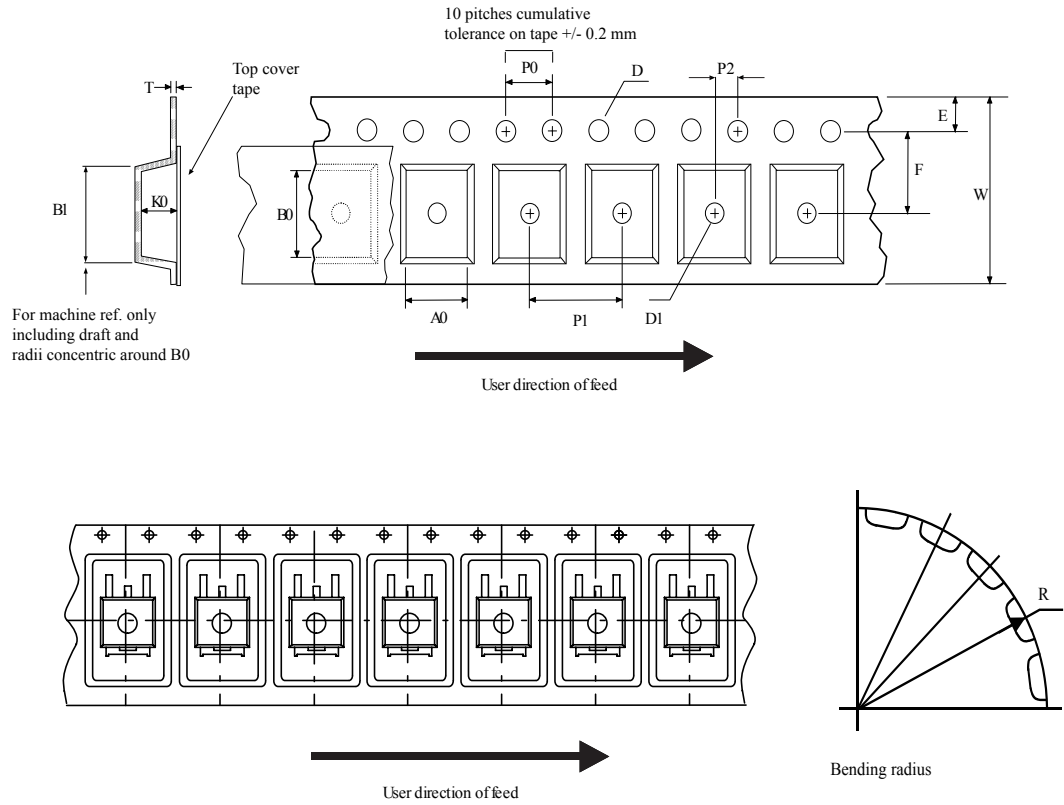

AM08852v1

Figure 23. DPAK (TO-252) reel outline

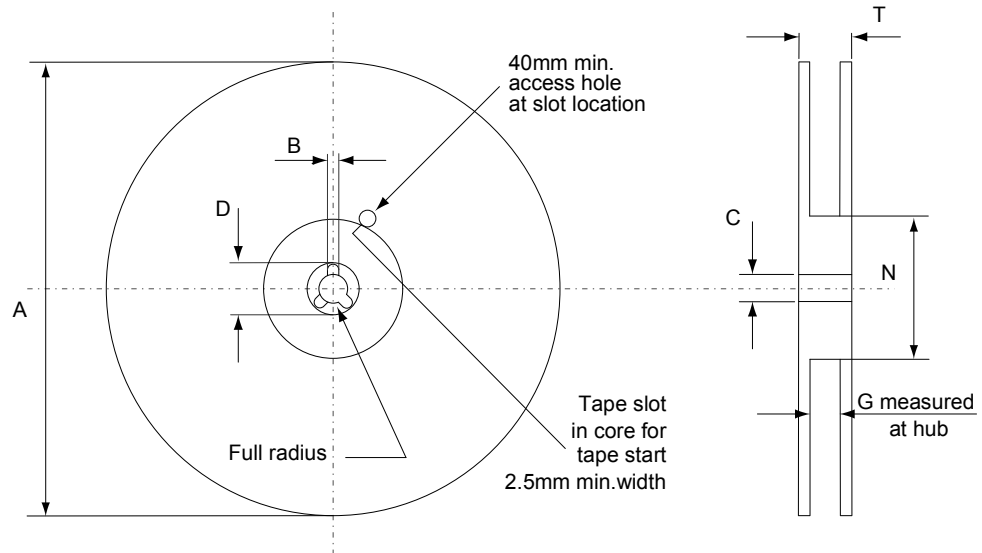

AM06038v1

Table 10. DPAK (TO-252) tape and reel mechanical data

Dim.	Tape		Dim.	Reel	
	mm			mm	
	Min.	Max.		Min.	Max.
A0	6.8	7	A		330
B0	10.4	10.6	B	1.5	
B1		12.1	C	12.8	13.2
D	1.5	1.6	D	20.2	
D1	1.5		G	16.4	18.4
E	1.65	1.85	N	50	
F	7.4	7.6	T		22.4
K0	2.55	2.75			
P0	3.9	4.1		Base qty.	2500
P1	7.9	8.1		Bulk qty.	2500
P2	1.9	2.1			
R	40				
T	0.25	0.35			
W	15.7	16.3			

Revision history

Table 11. Document revision history

Date	Revision	Changes
05-Jul-2016	1	First release.
17-May-2017	2	Updated <i>Section 1: "Electrical ratings"</i> . Added <i>Section 4.2: "DPAK (TO-252) type C package information"</i> . Minor text changes.
01-Jun-2018	3	Updated Table 3. Avalanche characteristics , Table 5. Dynamic , Figure 5. Gate charge vs gate-source voltage and Figure 7. Capacitance variations . Updated Section 4 Package information .

Contents

1	Electrical ratings	2
2	Electrical characteristics	3
2.1	Electrical characteristics (curves)	5
3	Test circuits	8
4	Package information	9
4.1	DPAK (TO-252) type A package information	9
4.2	DPAK (TO-252) type E package information	11
4.3	DPAK (TO-252) packing information	13
	Revision history	16

IMPORTANT NOTICE – PLEASE READ CAREFULLY

STMicroelectronics NV and its subsidiaries (“ST”) reserve the right to make changes, corrections, enhancements, modifications, and improvements to ST products and/or to this document at any time without notice. Purchasers should obtain the latest relevant information on ST products before placing orders. ST products are sold pursuant to ST’s terms and conditions of sale in place at the time of order acknowledgement.

Purchasers are solely responsible for the choice, selection, and use of ST products and ST assumes no liability for application assistance or the design of Purchasers’ products.

No license, express or implied, to any intellectual property right is granted by ST herein.

Resale of ST products with provisions different from the information set forth herein shall void any warranty granted by ST for such product.

ST and the ST logo are trademarks of ST. All other product or service names are the property of their respective owners.

Information in this document supersedes and replaces information previously supplied in any prior versions of this document.

© 2018 STMicroelectronics – All rights reserved

Mouser Electronics

Authorized Distributor

Click to View Pricing, Inventory, Delivery & Lifecycle Information:

[STMicroelectronics:](#)

[STD5N60DM2](#)