



7892

## 60° Bent Tip Snipe Nose Pliers with Synthetic Handle





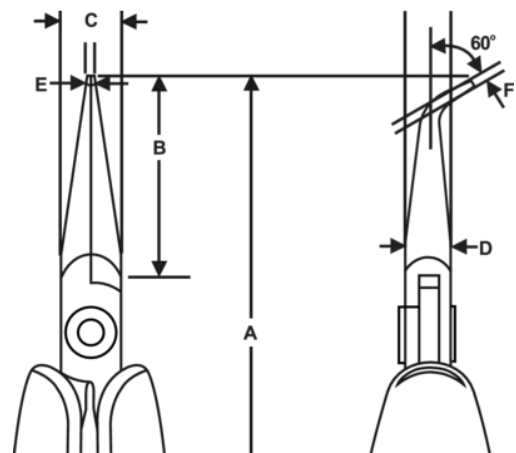

### PRODUCT DETAILS

- Supreme series snipe nose pliers with bent tip
- ESD safe mono-material handles with return spring
- High performance alloyed steel
- Polished finish
- Numerically controlled machine grinding guarantees accuracy & increases the tools reliability & consistency
- Tough hardened 42-46 HRC
- Screw joint that minimizes friction & maximizes jaw alignment
- 29 mm of smooth jaws bent at 60° with radiused edges







# PRODUCT ATTRIBUTES

## Product: 7892

	Bent Nose		M	<b>A</b>	129 mm
<b>A</b>	5.08 in	<b>B</b>	29 mm	<b>B</b>	1,14 in
<b>C</b>	9 mm	<b>C</b>	0.35 in	<b>D</b>	6 mm
<b>D</b>	0,24 inch	<b>E</b>	1,2 mm	<b>E</b>	0,05 in
<b>F</b>	0,8 mm	<b>F</b>	0,03 in		Smooth
	73 g	<b>Ω</b>	Dissipative		

## Product: 7892 CO

	Bent Nose		M	<b>A</b>	129 mm
<b>A</b>	5.08 in	<b>B</b>	29 mm	<b>B</b>	1,14 in
<b>C</b>	9 mm	<b>C</b>	0.35 in	<b>D</b>	6 mm
<b>D</b>	0,24 inch	<b>E</b>	1,2 mm	<b>E</b>	0,05 in
<b>F</b>	0,8 mm	<b>F</b>	0,03 in		Smooth
	73 g	<b>Ω</b>	Conductive		