

## Motor Mount and Wheel Kit –AL and –MP

–AL (#28962, aluminum) and –MP (#28963, molded plastic)

Each kit includes a 36-position Quadrature Encoder Set (#29321)

The Parallax Motor Mount and Wheel Kit –AL (aluminum) and –MP (molded HDPE plastic) are complete mechanical drive systems for sturdy and robust mid-sized mobile robots. Each kit is comprised of two independent drive assemblies that are mirror images of each other. Each assembly contains a right-angle worm-drive gear motor, axle and ball bearing unit, a six-inch pneumatic tire with tube, and an integrated encoder system that provides feedback to the microcontroller or processor of your choice.

This kit is designed for direct compatibility with our Arlo Robot Base Kit (#28960). It can be mounted to your own custom robot platform using the pre-tapped holes in the machined 6061 aluminum mounting blocks (-AL version) or in the pre-drilled holes on the injection molded High-density Polyethylene (HDPE) mounting blocks (-MP version). These kits are not backwards compatible with the previous Motor Mount and Wheel Kit with Position Controller (#27971). Please see the Product Compatibility section, page 13.

### Features

#### Both drive systems

- Conveniently located mounting holes for easy mounting to the Arlo Robot Base Kit or your own robotic platform design
- Rugged pneumatic tires well-suited for indoor and outdoor terrain
- Powerful and strong, yet light weight

#### Aluminum drive system (#28962)

- Powerful worm-drive DC gear-motors mount on precision machined 6061 solid aluminum Motor Mount Blocks
- Able to carry up to 60 lbs. of payload

#### HDPE drive system (#28963)

- Powerful worm-drive DC gear-motors mount on precision injection molded High-density Polyethylene (HDPE) Motor Mount Blocks
- Able to carry up to 20 lbs. of payload

#### Encoders

- 36-position Quadrature Encoders provide up to 144 pulses per revolution
- Dual-signal, out-of-phase outputs indicate direction
- Pulse widths indicate speed; number of pulses indicate distance traveled
- Easy to integrate with your robotic system designs

### Key Specifications

#### Drive system

- DC Motor nominal operating voltage: 12.0 VDC
- No load current: approx. 1.50 A
- 1.5 lbs. per drive assembly (two included in this kit)
- Approx. 100 RPM @ 12.0 VDC, 1.50 A, no load

#### Encoders

- Power requirements: 2.5 VDC @ 3.5 mA, 3.0 VDC @ 5.0 mA, 11.6 mA @ 5.5 VDC max.
- Communication: dual-channel high/low pulse output
- Dimensions: 2.0 x 1.1 x .25 in (5.1 x 2.7 x 0.6 cm)
- Operating temp: 32–158 °F (0–70 °C)

## Bill of Materials for #28962 (Aluminum)

Part #	Description	Quantity
750-90005	Motor, 12 VDC (left)	1
750-90006	Motor, 12 VDC (right)	1
29321	36-position Quadrature Encoder Set (contains 2 encoder assemblies)	1
34030	Motor Bearing Block 2 Aluminum	2
34015	Wheel, main rim – 6061 Aluminum	2
34016	Wheel, rim ring – 6061 Aluminum	2
34031	Robot Drive Axle 2	2
700-00100	1/8 x 1" Roll Pin	2
710-00015	Screw, #4-40x1/2", FH, SS	12
710-00031	Screw, M6, 1 mm x 50 mm SH, Black	6
710-00105	Screw, #1/4-20x5/8", BH, SS	2
713-00030	Spacer 0.50" x 1", RND, AL	6
721-00006	Knobby Tire, 6" x 1-1/4" Rubber w/tube	2
724-00001	0.5" ID x 1.125" OD Ball Bearing	2
725-00023	Hex Key, 5 mm	1
725-00024	Hex Key, 5/32"	1

## Bill of Materials for #28963 (Molded Plastic)

Part #	Description	Quantity
750-90005	Motor, 12 VDC (left)	1
750-90006	Motor, 12 VDC (right)	1
29321	36-position Quadrature Encoder Set (contains 2 encoder assemblies)	1
34031	Robot Drive Axle 2	2
34040	Motor Bearing Block 2MP	2
34041	Robot Rim Set 2MP	2
700-00100	1/8 x 1" Roll Pin	2
710-00045	Screw, #4-40x1", FH, SS	12
711-00008	#4-40 Acorn Nut	12
710-00031	Screw, M6, 1 mm x 50 mm SH, Black	6
710-00105	Screw, #1/4-20 x 5/8", BH, SS	2
713-00030	Spacer 0.50" x 1", RND, AL	6
721-00006	Knobby Tire, 6" x 1-1/4" Rubber w/tube	2
724-00001	0.5" ID x 1.125" OD Ball Bearing	2
725-00023	Hex Key, 5 mm	1
725-00024	Hex Key, 5/32"	1

## Tools Required

- Hex Keys: 5 mm and 5/32" (included)
- Screwdriver: #1 Phillips and flathead combination screwdriver (not included)
- Small wooden mallet or small regular hammer (not included)
- Wood block (not included)
- Tire pump and air chuck (preferably a bicycle hand pump, not included)

## Assembly Instructions

Although two sets are included in your kit, these assembly details depict one motor assembly. You will need to assemble both sets – one is a mirror image of the other.

## Step 1: Axle

Align the axle's socket with the motor's square drive shaft and press-fit it into place.

Although the axle is precision machined to fit with the motor shaft, sometimes the axles will slide on effortlessly, or they may require a very gentle tap from a non-steel hammer to seat them as shown below. This is due to manufacturing tolerances on the motors.

When you first put the axle on the shaft it may seem loose and wiggle around a bit...this is normal. Once you install the block and screws the wiggle will almost entirely disappear. This is well within the drive system and encoder's resolution design parameters.



When the drive shaft is all the way on the motor drive pin, it should look like this. The distance between the motor housing and the large end of the axle should be approximately one-tenth of an inch.



## Step 2: Encoder Disk

Next, remove any debris from the internal fins on the encoder disk (a toothpick, fingernail or tiny screwdriver work well). Slide the encoder disk onto the drive shaft. The internal teeth on the disk will deform slightly and grip the shaft.



## Step 3: Bearing

Slide the bearing onto the drive shaft.



#### Step 4: Bearing Block

Insert the motor and axle assembly into the Bearing Block. The Bearing Blocks are interchangeable, and therefore can be used on either side of the device. Be certain that the bearing is completely seated within the cavity – it should be a very snug fit.

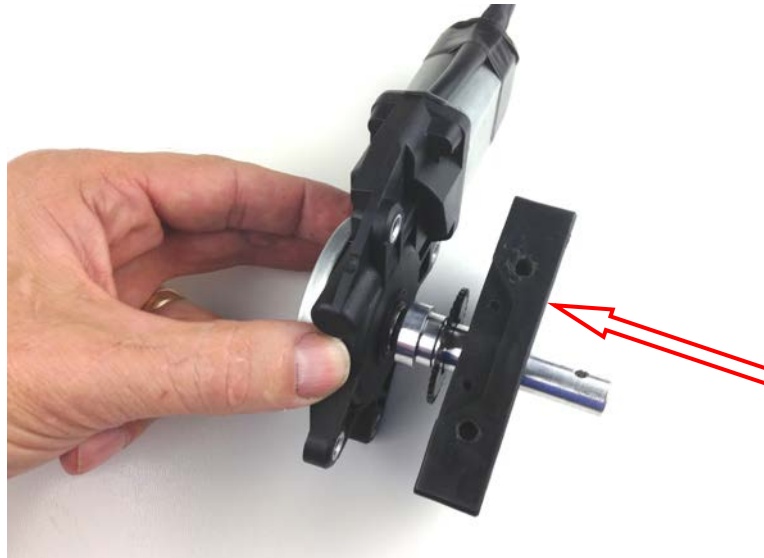

#### Step 5: Bearing Block and Drive Pin

Insert the drive pin into the axle. Use a non-marring hammer (or be very careful with a regular hammer), and tap it in gently. It should be a “friction” fit.

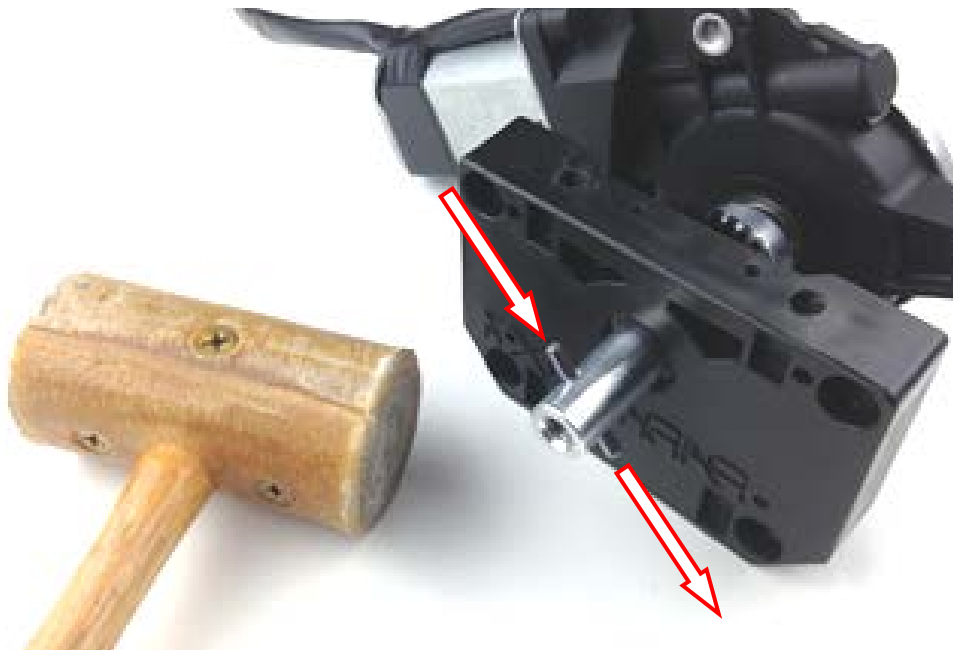

## Step 6: Bearing Block and Axle Assembly

Using (3) 50 mm hex-head socket screws, and (3) 1" x 0.5" standoffs, attach the motor/drive axle assembly to each of the motor bearing blocks as shown.

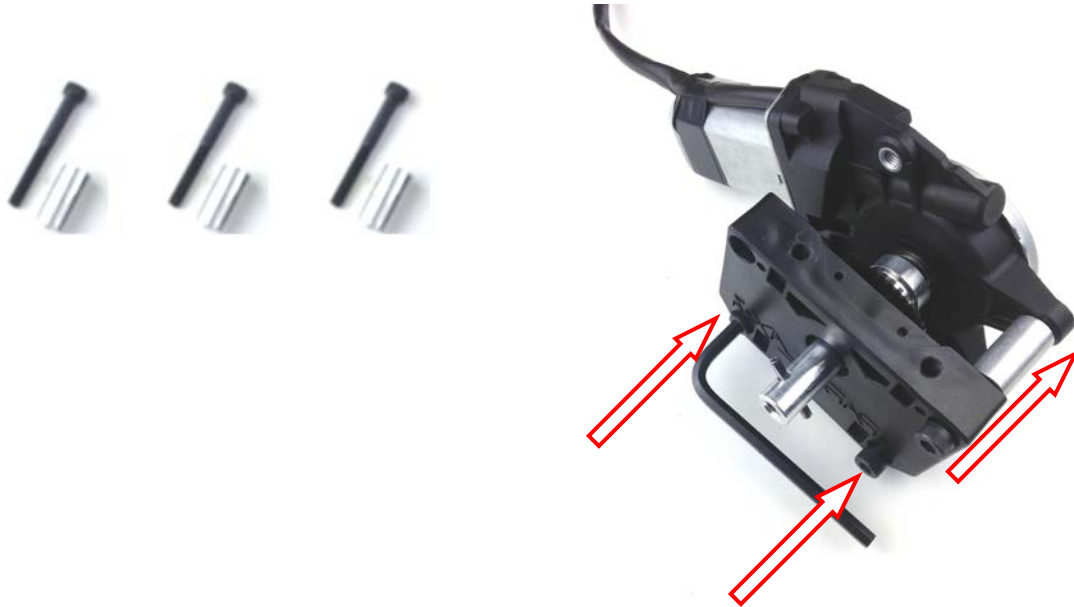

## Step 7: Encoder Cables

Plug the encoder cables into each of the encoder boards as shown. Be sure to match the wire color with the B-R-W color-coding on the boards. The white wires will be adjacent to each other in the center of the connector.

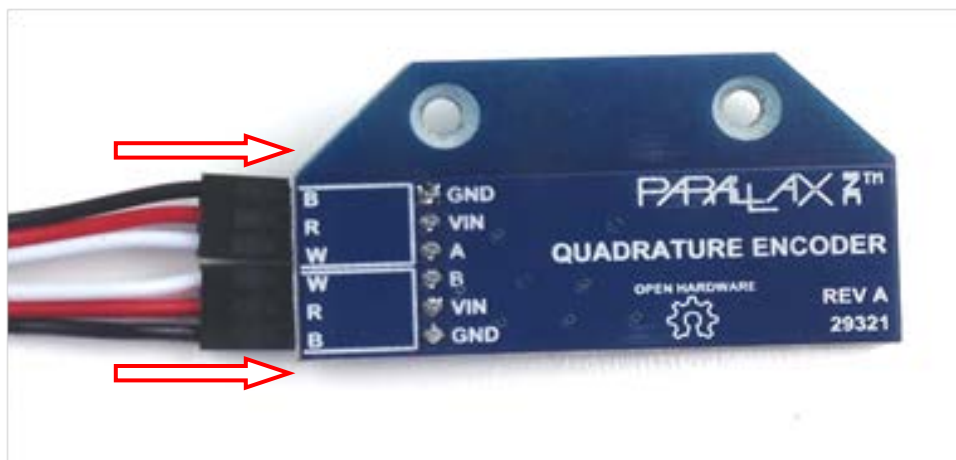

## Step 8: Mount Encoder Boards

Carefully mount the encoder boards in the cavities as shown. You should position the encoder boards over the encoder disks such that the disks fit in the center of the slot on the encoder sensor.

Fasten the encoder board to the motor bearing blocks using the flat-head Phillips screws provided. When mounting the encoders to the HDPE blocks, be careful not to over-tighten. The -MP blocks are designed to allow the screws to cut their own threads into the plastic as you drive them in. Be gentle! They will hold well, as long as you don't strip out the mounting holes (-MP version). If you do happen to strip out the holes, you can install slightly longer screws and use nuts on the underside (not included).

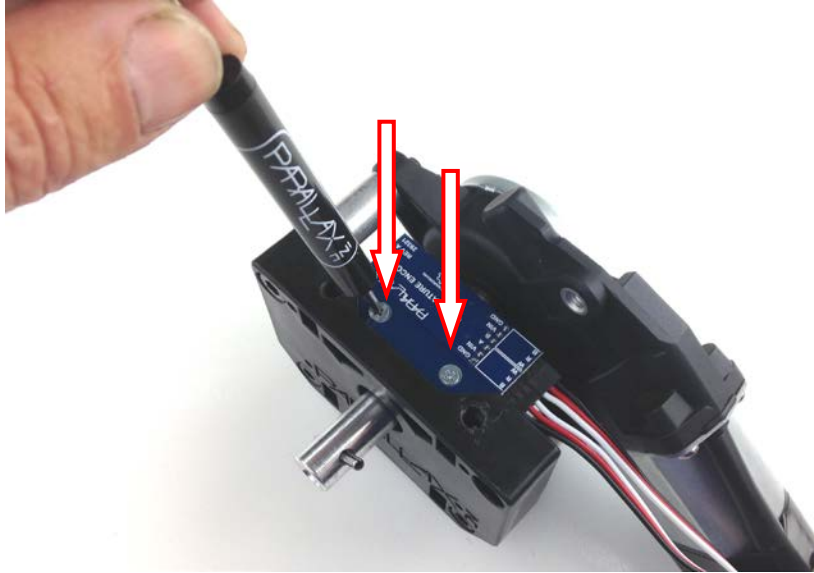

This completes the assembly of one of the drive units. Duplicate what you just accomplished and when you're finished the result is two separate motor drive units that are mirror images of each other—one for the right side and one for the left side of your robot platform, as shown here.





### Step 9: Drive Wheel Assembly Parts

The HDPE and Aluminum drive assemblies have the same shaped pieces. The aluminum version utilizes tapped holes in the rim sections to hold the pieces together, whereas the HDPE version relies on additional #4-40 acorn nuts.



### Step 10: Inner Tube

Begin by inflating the inner tubes with a bicycle pump. Add just enough air to make them round, but not under any pressure. Insert them into the tires as shown. This will help keep the tube and tread in alignment as you're sandwiching the split rim wheel system together.





## Step 11: Rims

Place the main rim over the valve stem, being sure to line up the stem notch as shown below. Push it down tight so that the rim is well seated into the rubber tire.



The aluminum wheel kit uses #4-40 x ½" long flat head bolts which screw directly into tapped holes on the aluminum Main Rim section.

The HDPE wheel kit uses the #4-40 x 1" long screws and acorn nuts that fit into a recess on the plastic Main Rim section. Think of them as miniature "lug nuts" that hold your wheel together.

Put a screw or bolt (depending on which kit you have) into each of the holes in the inner rim. Then, place the inner rim on the tire as shown, aligning the bolts or screws with the holes in the main rim.



**Secure Rims - Aluminum Version:** Best practice for assembly is to get all of the screws started into their respective threaded holes. Then, tighten each one slightly and slowly go around the circle, which brings the two rim sections together evenly. Also, be sure to not pinch or bind the tube while screwing the assembly together.

**Secure Rims – HDPE Plastic Version:** Insert an acorn nut into its cavity in the main rim, and tighten the screw from the inner rim side with a screwdriver. Repeat with the remaining nuts. Avoid pinching the tube while screwing the two halves together.

## Step 12: Inflate Tires

Inflate the tires; 20–25 psi is optimum for traction, load capacity, and shock absorption. HIGHLY ADVISE using a bicycle hand pump to inflate the tires since the air capacity is so small, or a regulated air compressor set between 20 and 25 psi for safety and best results. DO NOT EXCEED 35 PSI as this may cause the tube to rupture and/or break the inner rim of the HDPE version of the kit.

## Step 13: Mount Assemblies to Drive Shaft

Next, mount the wheel assemblies to the drive shaft, being careful to align the drive pin to the slots cut into the rim assemblies. Attach the wheels with (1) #¼-20 x 5/8" Button Head Screw on each assembly.



You should now have two drive assemblies that look like this:



## Step 14: Mounting to a Robot Platform

If you are using your Motor Mount and Wheel Kit with the Arlo Robot Base Kit (#28960), follow the mounting instructions in that product's documentation. Go to [www.parallax.com](http://www.parallax.com) and search "28960."

To mount this drive system to your robotic platform of choice, you can use the mounting holes shown below (wheels removed for clarity).

### HDPE Plastic Version

In the HDPE version the mounting holes on the top and bottom of the mounting block are pre-drilled to a depth of 6/10" for self-tapping by driving a #1/4-20 screw into them, of whatever length is necessary for the thickness of your chosen platform.

You can pre-tap the HDPE plastic if you prefer, however the properties of HDPE allow you drive the screw in directly. The screw cuts its own threads and once it's in, the HDPE tends to bind to the screws much like a Nylon lock-nut, resulting in a surprisingly strong mechanical connection.

### Aluminum Version

In the aluminum version, the mounting holes on the top and bottom of the mounting block are pre-drilled and pre-tapped to a depth 6/10" to accommodate a #1/4-20 screw of whatever length is necessary for the thickness of your chosen platform.

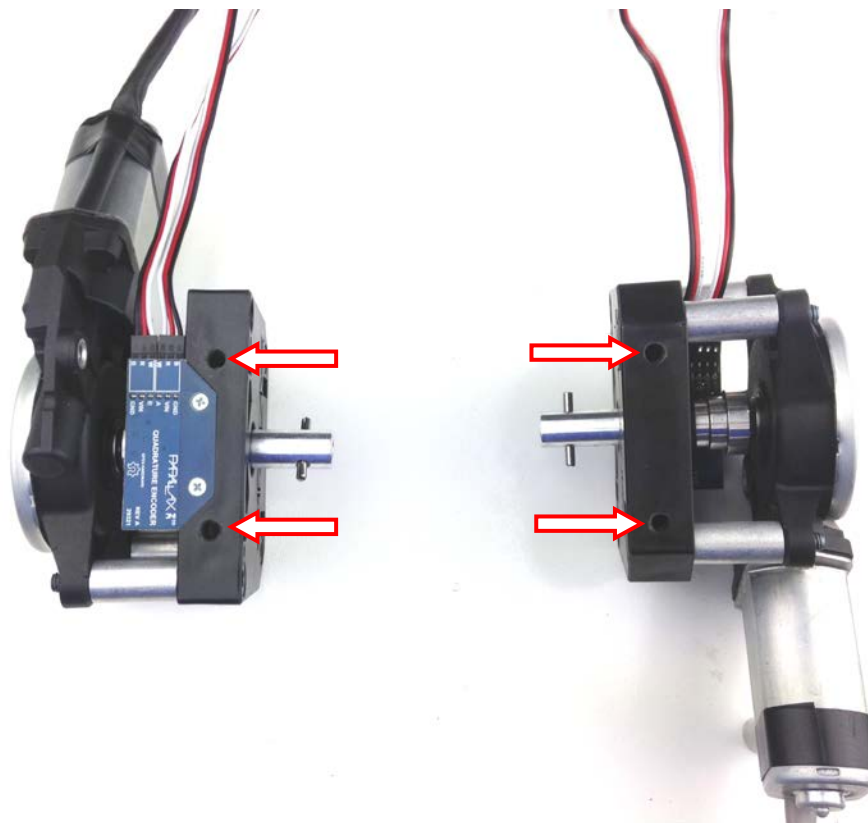

## 36-position Quadrature Encoder Operation

The 36-position Quadrature Encoders provide a convenient means to reliably track the position and speed of each wheel at all times. With the (included) Encoder disks, each Encoder assembly has a basic resolution of 36 positions per rotation. However, because there are two sensors in each assembly, this results in a potential resolution of 144 positions per full tire rotation. This translates to a linear resolution of approximately 0.13 inches of travel per drive assembly, using the stock six-inch tires. Actual resolution will be limited by the amount of backlash in each of the gear motor assemblies, which is approximately +/- 0.175 lineal inches.

The 36 Position Quadrature Encoder Kit employs a dual-slotted sensor mounted on a printed circuit board (PCB). This module contains a single infrared light source on one side of its slot, and two separate sensors embedded into the opposite side of the slot.

When the encoder disk rotates and swings through the slot, each individual fin on the disk blocks first one sensor, and then the other, from the light source. The first blocked sensor transitions from low to high, and then, as the encoder disk continues to rotate, the second sensor is blocked and it too transitions from low to high. These two signals overlap each other, as shown in the diagram below.

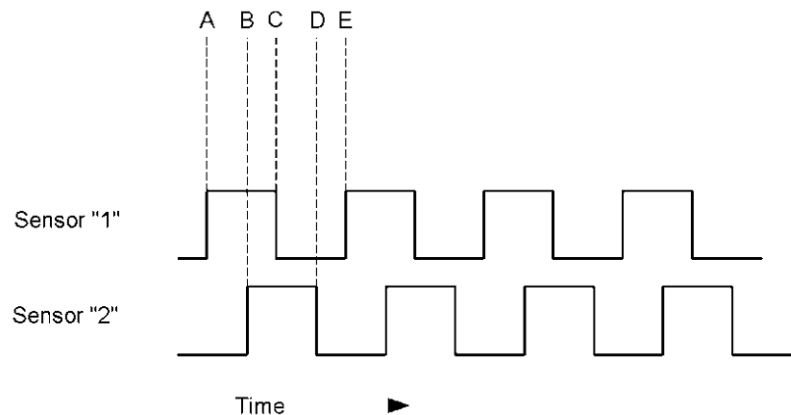

In the diagram, notice that after sensor 1 goes high (A), sensor 2 then goes high (B) as the encoder continues to rotate. Then, as the encoder continues to spin, sensor 1 goes low (C), and then sensor 2 follows (D). Because sensor 1 went high before sensor 2 (A-B), this indicates that the encoder disk is rotating in one direction (in the case of a robot, either forward or reverse). If sensor 2 went high before sensor 1, then the disk is rotating in the opposite direction. By interpreting these two signals, the following can be determined:

- Whether or not the device is moving (by detecting transitions on either sensor).
- The direction in which the device is moving (by detecting which sensor transition occurs first).
- The speed at which the device is moving—by measuring the widths of each pulse, or by measuring the frequency of the pulses.
- The total distance traveled (by counting the number of pulses from either sensor).

The Quadrature Encoders are compatible with most any microcontroller. Keep in mind that the Encoders provide pure, real-time data; there is no processing delay on the Encoder board itself. The Encoder delivers two high-speed output channels (through the white wires) to the circuit (or microcontroller) of your choice.

## Product Compatibility Notice

The original Motor Mount and Wheel Kit (#27971) contained Position Controller Kits (#27906). The current version of the kit includes 36-position Quadrature Encoder Kits. The 36-position Quadrature Encoder Kit is NOT an electrical drop-in replacement for the Position Controller Kits. *The communication protocols and electrical connections are substantially different.* Microcontroller code written for one system would not be compatible for the other. For information about the Position Controller Kits search 27906 at [www.parallax.com](http://www.parallax.com).

### **The Motor Mount and Wheel Kit –AL (#28962) and –MP (#28963) ARE compatible with:**

- Arlo Robot Base Kit (#28960)
- Caster Wheel Kit Rev B (#28961)
- Arlo Top Deck Kit (#28965)

### **The Motor Mount and Wheel Kit –AL (#28962) and –MP (#28963) are NOT compatible with:**

- MadeUSA Robot Base Kit (#28970)
- Caster Wheel Kit (#28971)
- Eddie Fully Assembled (#28990)
- Eddie Unassembled (#28992)

## Revision History

**Version 1.0:** original release

**Version 1.1:** Updated Step 1: Axle, page 3.